

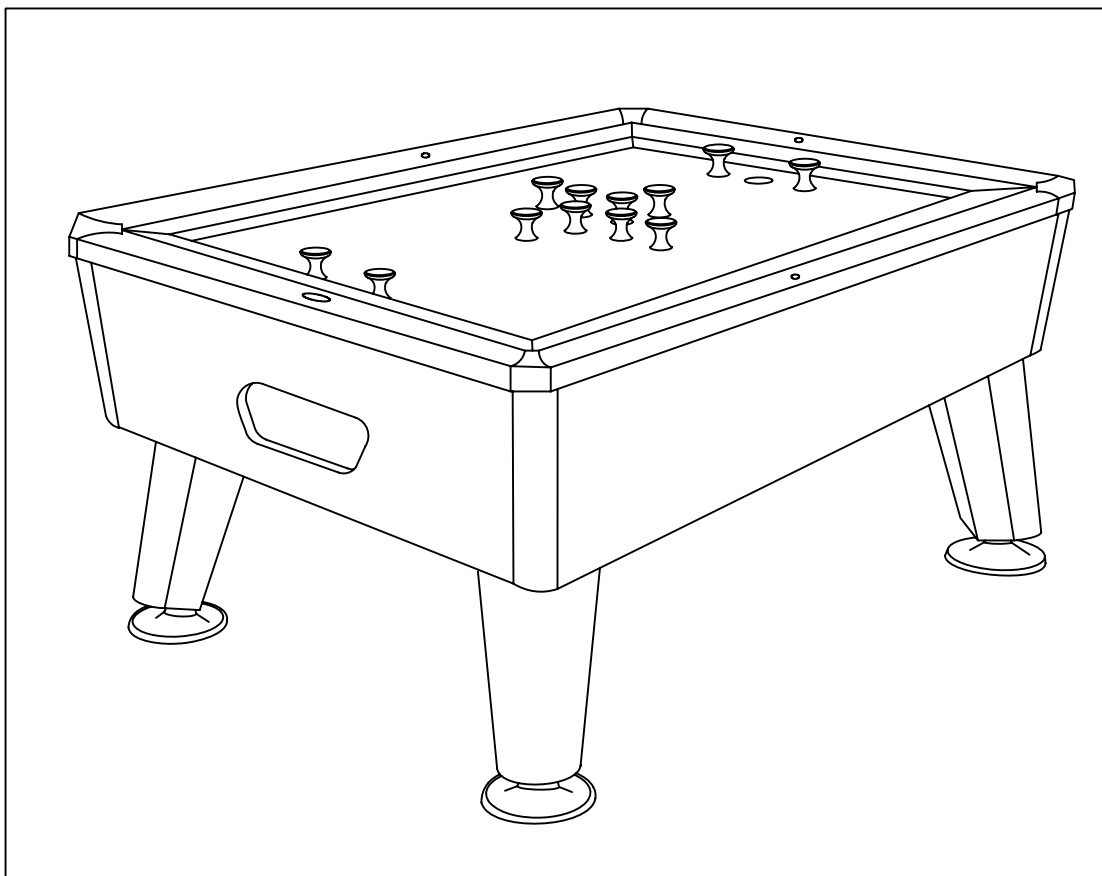

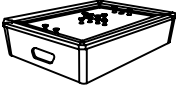





Home style commercial slate bumper pool table

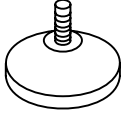
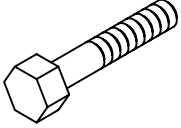

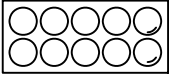
Item-No.: BB-CP-01-S
BB-CP-02-S

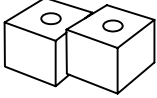
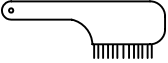
Parts List

<p>#1</p>  <p>Main frame 1 piece</p>	<p>#2</p>  <p>Leg 4 pieces</p>	<p>#3</p>  <p>Leg leveler 4 pieces</p>	<p>#4</p>  <p>3/8"X1-1/2" Bolt 12 pieces</p>
<p>#5</p>  <p>3/8"x23mm Washer 12 pieces</p>	<p>#6</p>  <p>balls 1 piece</p>	<p>#7</p>  <p>Cue stick 2 pieces</p>	<p>#8</p>  <p>Chalk 2 pieces</p>
<p>#9</p>  <p>Brush 1 piece</p>	<p>#10</p>  <p>Wrench 1 piece</p>		

Step 1:

