

**NOTICE DE MONTAGE**  
**ASSEMBLING INSTRUCTIONS**  
**INSTRUKCJA MONTAŻU**  
**MONTAGEANLEITUNG**

**INSTRUCCIONES DE INSTALACIÓN**  
**ISTRUZIONI DI INSTALLAZIONE**  
**UPUTE ZA UGRADNJU**  
**INSTRUÇÕES DE INSTALAÇÃO**

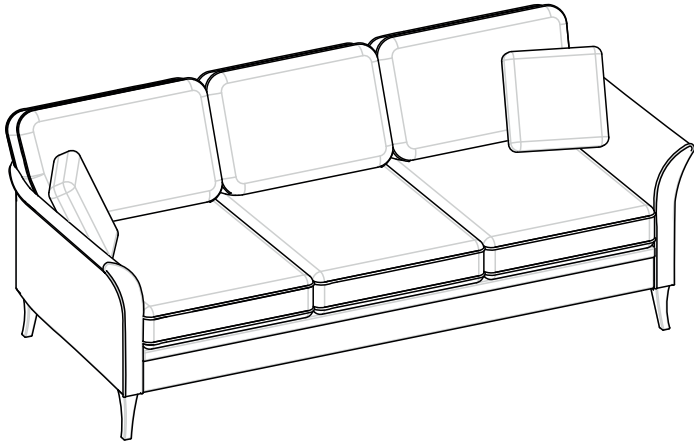

## 3 Seater Sofa



5min



x2

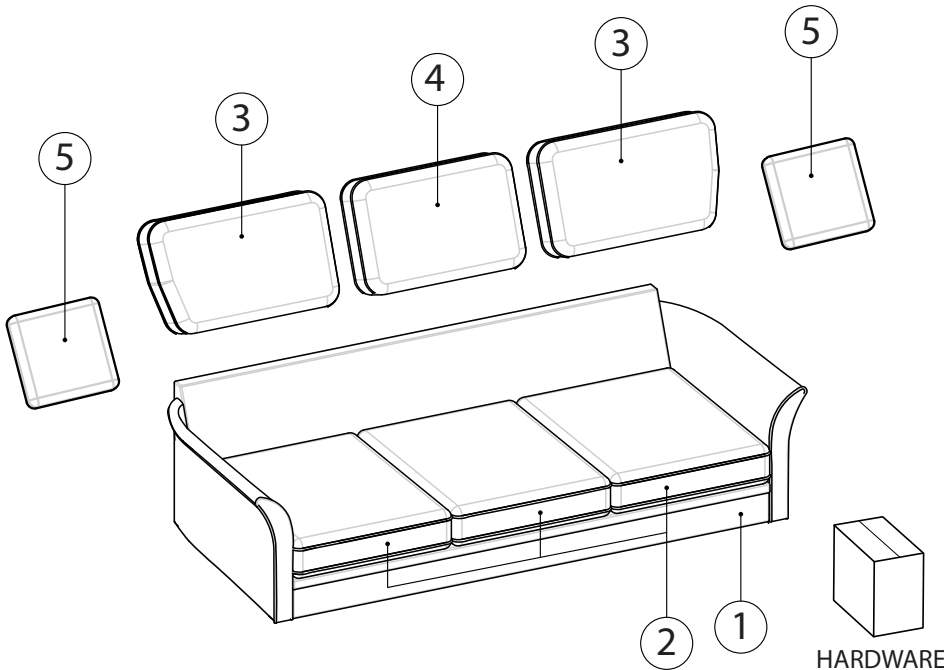

Pack 1 / 1

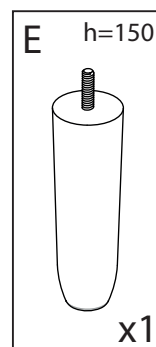
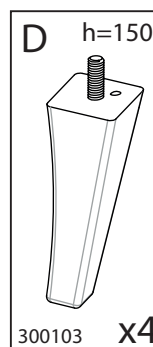
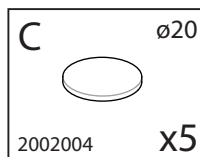
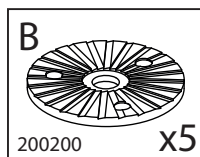
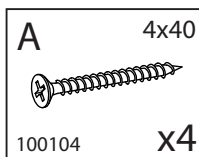
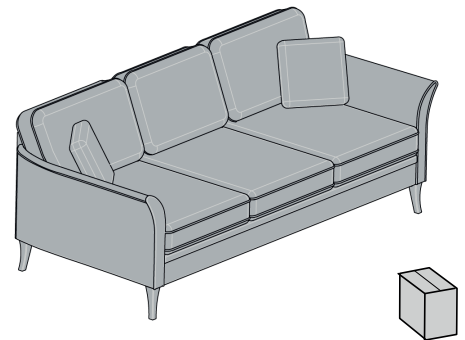



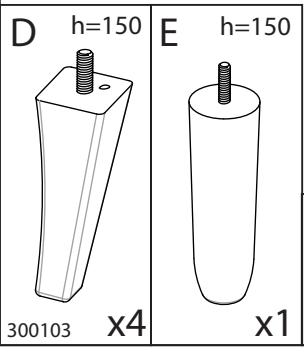
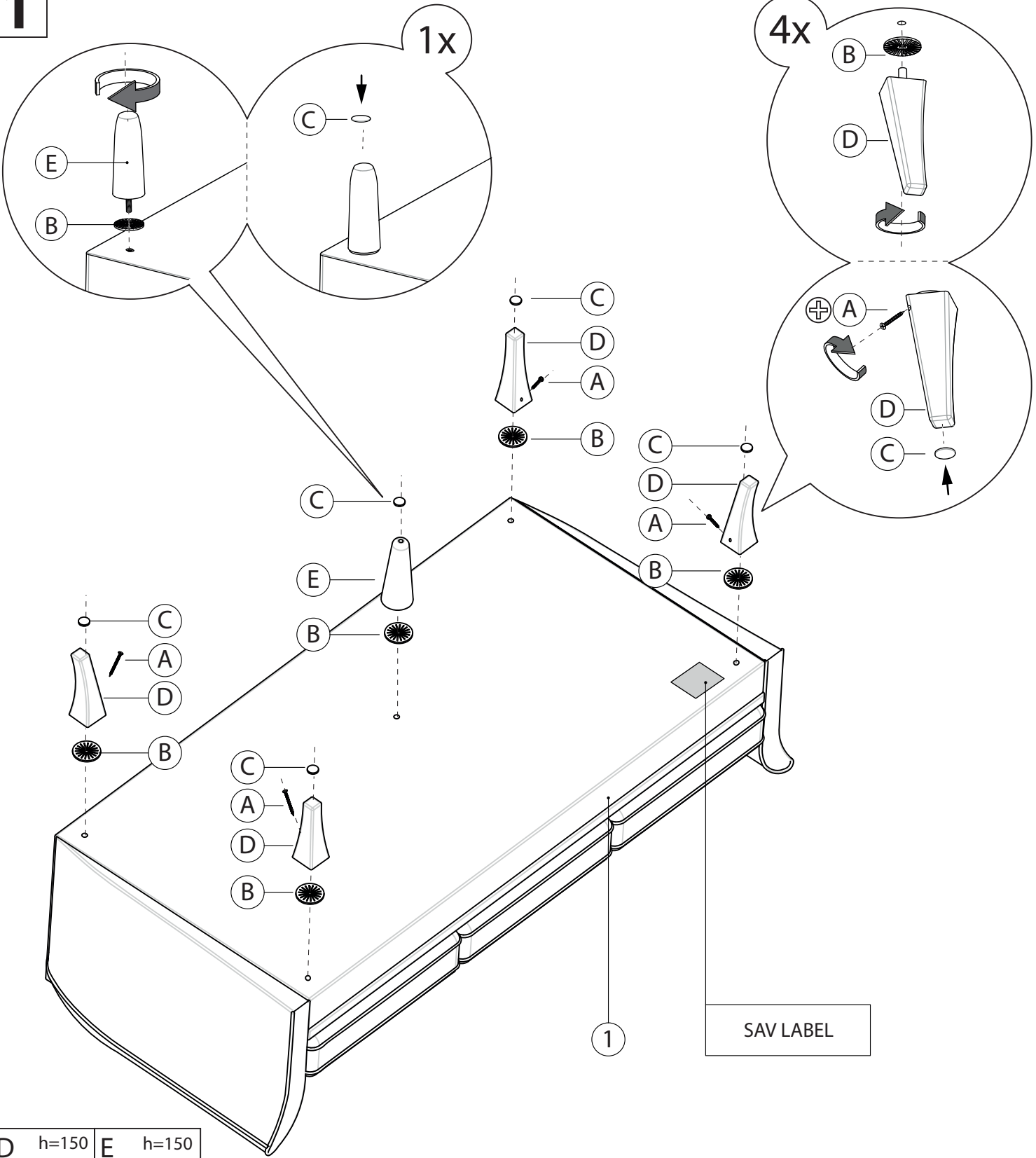

**NOTICE DE MONTAGE**  
**ASSEMBLING INSTRUCTIONS**  
**INSTRUKCJA MONTAŻU**  
**MONTAGEANLEITUNG**

**INSTRUCCIONES DE INSTALACIÓN**  
**ISTRUZIONI DI INSTALLAZIONE**  
**UPUTE ZA UGRADNJU**  
**INSTRUÇÕES DE INSTALAÇÃO**

**1**



	<b>A</b> 4x40 	<b>B</b> 	<b>C</b> ø20 
	100104 x4	200200 x5	2002004 x5

**NOTICE DE MONTAGE**  
ASSEMBLING INSTRUCTIONS  
**INSTRUKCJA MONTAŻU**  
MONTAGEANLEITUNG

INSTRUCCIONES DE INSTALACIÓN  
**ISTRUZIONI DI INSTALLAZIONE**  
UPUTE ZA UGRADNJU  
**INSTRUÇÕES DE INSTALAÇÃO**

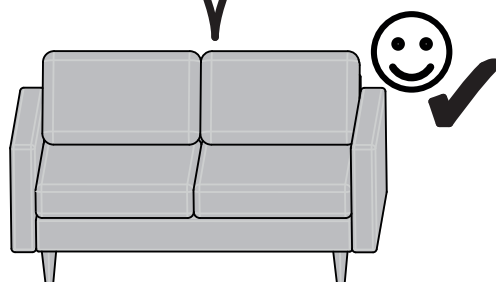
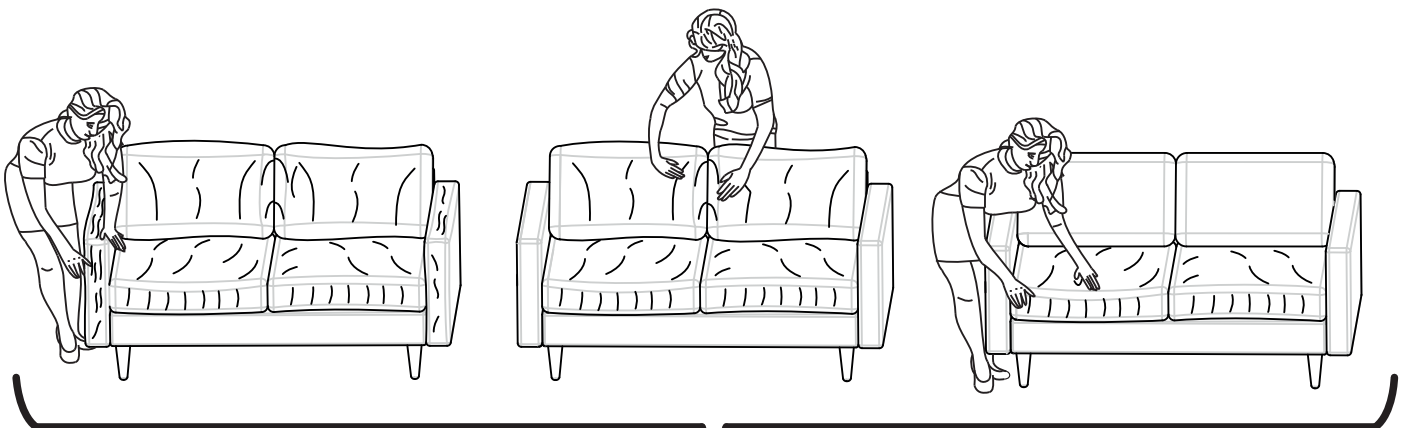
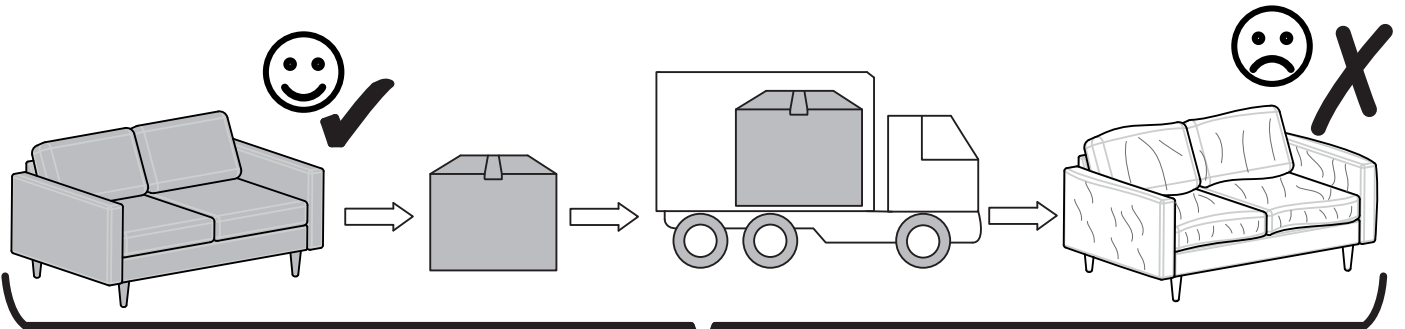
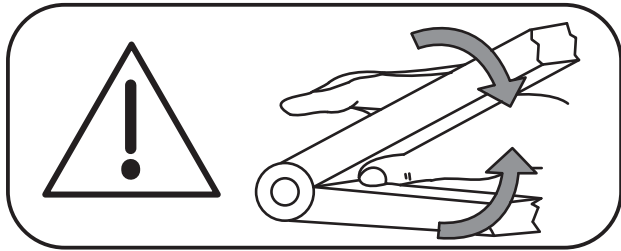
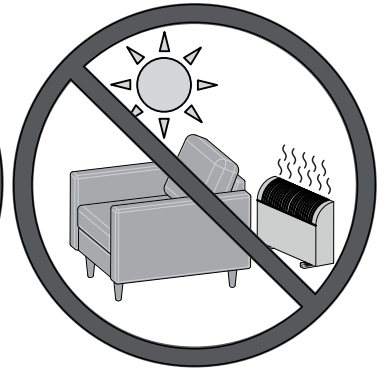

**NOTICE DE MONTAGE**  
**ASSEMBLING INSTRUCTIONS**  
**INSTRUKCJA MONTAŻU**  
**MONTAGEANLEITUNG**

**INSTRUCCIONES DE INSTALACIÓN**  
**ISTRUZIONI DI INSTALLAZIONE**  
**UPUTE ZA UGRADNJU**  
**INSTRUÇÕES DE INSTALAÇÃO**

**ENGLISH** **ASSEMBLY ADVICE:** **CLEANING ADVICE:**

 NEVER FORCE THE CONNECTIONS. RE-TIGHTEN THE SCREWS AFTER FEW DAYS. PLEASE RETAIN THE AI LEAFLET FOR FUTURE REFERENCE. THE AI CONTAINS INFORMATION WHEN CLAIMING FOR MISSING PARTS.

 NEVER USE ABRASIVE PRODUCTS OR SOLVENTS. DO NOT APPLY EXCESSIVE PRESSURE WHEN USING THE DAMP CLOTH.

1 > CAREFULLY READ THE ASSEMBLY INSTRUCTION.  
 2 > IDENTIFY THE COMPONENTS OF THE FURNITURE.  
 3 > GROUP AND CHECK THE HARDWARE.  
 4 > USE THE REQUIRED TOOLS.  
 5 > CREATE AN ASSEMBLY ZONE.  
 6 > MAKE THE ASSEMBLY.

1 > CAREFULLY REMOVE THE DUST.  
 2 > USE A CLEAN, SOFT, DAMP CLOTH.  
 3 > (FABRIC FURNITURE) COMB THE WRINKLES CAUSED BY THE PACKAGING WITH A BRUSH.

	PAPER DECOR	LAMINATED SURFACES	LACQUERED SURFACES	VARNISHED WOOD	LEATHER TEXTILE
SOAPY WATER (NEUTRAL SOAP)	●	●	●	●	●
WATER WITH DETERGENT		●	●		
SPECIFIC SUPPLIER CLEARING					●

**DEUTSCH - SCHWEIZ** **MONTAGE ANLEITUNG:** **MONTAGE ANLEITUNG:**

 NIEMALS DIE VERBINDUNGEN ZU STARK ANZIEHEN. DIE SCHRAUBEN NACH EINIGER ZEIT DES GEBRAUCHS ERNEUT FESTZIEHEN. DIE MONTAGEANLEITUNG GUT AUFBEWAHREN: SOLLTE EIN TEIL FEHLEN, IST SIE DAS BESTE VERSTÄNDIGUNGSMITTEL MIT IHREM GESCHÄFT.

 BENUTZEN SIE KEINE SCHEUERMITTEL WIE PULVER, STAHLWOLLE, LÖSUNGSMITTEL. KEIN WASSER VERWENDEN.

1 > DIE MONTAGEANLEITUNG SORGFÄLTIG DURCHLESEN.  
 2 > DIE EINZELTEILE DES MÖBELSTÜCKES ERMITTELN.  
 3 > DIE BESCHLÄGE ZUSAMMENLEGEN UND PRÜFEN.  
 4 > DAS NOTWENDIGE WERKZEUG ZURECHTLEGEN.  
 5 > EINEN MONTAGEBEREICH FREI-MACHEN.  
 6 > DAS MÖBELSTÜCK ZUSAMMENBAUEN.

1 > SORGFÄLTIG ENTSTAUBEN.  
 2 > VERWENDEN SIE EIN SAUBERES, WEICHES, FEUCHTES TUCH.  
 3 > (MÖBEL AUS STOFF) KÄMMEN SIE MIT EINE BÜRSTE DIE DURCH DIE VERPACKUNG VERURSACHTEN FALTEN AUS.

	DEKORPAPIER	OBERFLÄCHE LAMINIERT	OBERFLÄCHE LACKT	LACKIERTEM HOLZ	TEXTIL LEDER
SEIFEN LAUGE (NEUTRALSEIFE)	●	●	●	●	●
WASSER MIT HAUSHALTSREINIGER		●	●		
PRODUZENT SPEZIFISCHER UNTERHALT					●

**FRANÇAIS - SUISSE** **CONSEILS DE MONTAGE:** **CONSEILS D'ENTRETIEN:**

 NE JAMAIS FORCER LES ASSEMBLAGES. RESERRERZ LES VIS APRES QUELQUES TEMPS D'USAGE. GARDER VOTRE NOTICE DE MONTAGE, SI UNE PIÈCE VENAIT A MANQUER, ELLE SERAIT LE PLUS CLAIR MOYEN DE COMMUNIQUER AVEC VOTRE MAGASIN.

 NE JAMAIS UTILISER DE PRODUITS ABRASIFS: POUDRE, LAINE D'ACIER, SOLVANTS. NE PAS MOUILLER.

1 > BIEN ETUDIER LA NOTICE DE MONTAGE.  
 2 > REPEREZ LES PIÈCES CONSTITUANT VOTRE MEUBLE.  
 3 > REGROUPEZ ET CONTROLEZ LA QUINCAILLERIE.  
 4 > MUNISSEZ-VOUS DE L'OUTILLAGE NECESSAIRE.  
 5 > AMENAGEZ-VOUS UNE ZONE DE MONTAGE.  
 6 > PROCEDEZ AU MONTAGE.

1 > DÉPOUSSEZERZ SOIGNEUSEMENT.  
 2 > UTILISEZ UN CHIFFON PROPRE, DOUX ET HUMIDE.  
 3 > (MOBIELIER EN TISSU) PEIGNEZ LES RIDES CAUSEES PAR L'EMBALLAGE AVEC UNE BROSEE.

	PAPIER DECOR	SURFACES STRATIFIEES	SURFACES LAQUEES	BOIS VERNIS	TEXTILE CUIR
EAU SAVONNEUSE (SAVON NEUTRE)	●	●	●	●	●
EAU ADOUCISSANT		●	●		
ENTRETIEN SPECIFIQUE FABRICANT					●

**POLSKI** **WSKAZÓWKI MONTAŻOWE:** **WSKAZÓWKI CZYSZCZENIA:**

 NIE UŻYWAJ NADMIERNEJ SIŁY PODCZAS MONTAŻU. DOKRĘĆ ŚRUBY PO KILKU DNACH. PROSZĘ ZACHOWAĆ ULOTKĘ AI NA PRZYSZŁOŚĆ, AI ZAWIERA INFORMACJE POTRZEBNE DO ZGŁOSZENIA BRAKUJĄCYCH CZĘŚCI.

 NIGDY NIE UŻYWAJ PRODUKTÓW ŚCIERNYCH LUB ZAWIERAJĄCYCH ROZPUSZCZALNIKI. NIE NALEŻY NADMIERNE POCIERAĆ POWIERZCHNI MEBLA PODCZAS UŻYWANIA ŚCIERKI.

1 > NALEŻY DOKŁADNIE PRZECZYTAĆ INSTRUKCJĘ MONTAŻU.  
 2 > ZIDENTYFIKOWAĆ CZĘŚCI MEBLA.  
 3 > POGRUPUJ I SPRAWDŹ CZĘŚCI.  
 4 > UŻYJ WYMAGANYCH NARZĘDZI.  
 5 > STWÓRZ STREFĘ MONTAŻOWĄ.  
 6 > DOKOŃCZ MONTAŻ.

1 > DOKŁADNIE ZETRZYJ PYŁ.  
 2 > UŻYWAJ MIĘKIEJ, CZYSTEJ, WILGOTNEJ ŚCIERKI.  
 3 > (MEBEL W TKANINIE) ZA POMOCĄ SZCZOTKI ROZCIESZĄC ZAGĘCIA WYWOŁANE OPAKOWANIEM.

	DEKOR PAPIEROWY	POWIERZCHNIE LAMINOWANE	POWIERZCHNIE LAKIEROWANE	DREWNO LAKIEROWANE	SKÓRA TKANINA
WODA Z WYWIEM (WYDŁO NEUTRALNE)	●	●	●	●	●
WODA Z DETERGENTEM		●	●		
CZYSZCZENIE PRODUKTEM DOSTAWCY					●

**PORTUGUÊS** **CONSELHOS DE MONTAGEM:** **CONSELHOS PARA A MANUTENÇÃO:**

 NUNCA FORÇAR OS ENCAIXES. REAPERTAR OS PARAFUSOS APÓS UM TEMPO DE UTILIZAÇÃO. GUARDARAS INSTRUÇÕES DE MONTAGEM. CASO FALTE ALGUMA PEÇA, O MAIS ACONSELHÁVEL É CONTATAR O REVENDEDOR.

 NUNCA UTILIZAR PRODUTOS ABRASIVOS: SAPONÍFICOS, LÁ DE AÇO, SOLVENTES. NÃO MOLHAR.

1 > ESTUDE BEM AS INSTRUÇÕES DE MONTAGEM.  
 2 > REUNA AS PEÇAS QUE CONSTITUEM O SEU MÓVEL.  
 3 > REAGRUPA OS FERRAGENS.  
 4 > EQUIPE-SE COM AS FERRAMENTAS NECESSÁRIAS.  
 5 > PREPARE UMA ÁREA PARA A MONTAGEM.  
 6 > INICIE A MONTAGEM.

1 > ELIMINAR BEM O PÓ.  
 2 > USE UM PANO LIMPO, MACIO E ÚMIDO.  
 3 > (MÓVEIS DE TECIDO) PENTRE AS RUGAS CAUSADAS PELA EMBALAGEM COM UM PINCEL.

	ACABAMENTO IMITAÇÃO	SUPERFÍCIES ESTRATIFICADAS	SUPERFÍCIES LACADAS	MADERA ENVERNIZADA	TEXTÉIS PELES
ÁGUA COM SABÃO (SABÃO NEUTRO)	●	●	●	●	●
ÁGUA COM DETERGENTE		●	●		
INSTRUÇÕES ESPECÍFICAS DO FABRICANTE					●

**ITALIANO - SVIZZERA** **CONSIGLI DI MONTAGGIO:** **CONSIGLI PER LA MANUTENZIONE:**

 NON FORZARE MAI GLI ASSEMBLAGGI RISTRINGERE LE VITI DOPO UN PERIODO D'USO. CONSERVARE QUESTE ISTRUZIONI DI MONTAGGIO, SE UN PEZZO VENISSE A MANCARE SAREBBE IL MIGLIORE MEZZO DI COMUNICAZIONE CON IL RIVENDITORE.

 NON UTILIZZARE MAI PRODOTTI ABRASIVI: POLVERE, LANA DI ACCIAIO, SOLVENTI. NON BAGNARE.

1 > STUDIARE BENE LE ISTRUZIONI DI MONTAGGIO.  
 2 > PRENDERE CONOSCENZA DEI PEZZI CHE COSTITUISCONO IL MOBILE.  
 3 > RAGGRUPPARE E CONTROLLARE LA FERRAMENTA.  
 4 > MUNIRSI DEGLI UTENSILI NECESSARI.  
 5 > PREPARARE UNA ZONA DI MONTAGGIO.  
 6 > PROCEDERE AL MONTAGGIO.

1 > SPOLVERARE ACCURATAMENTE.  
 2 > UTILIZZARE UN PANNINO PULITO, MORBIDO E UMIDO.  
 3 > (MOBILI IN TESSUTO) PETTINARE LE RUGHE CAUSATE DALLA CONFEZIONE CON UN PENNELLO.

	CARTA	SUPERFICIE STRATIFICATE	SUPERFICIE LACATE	LACCATE EGNO VERNICIATO	TESSILE CUIO
ACQUA CON SAPONE (SAPONE NEUTRO)	●	●	●	●	●
ACQUA CON DETERSIVO SAN MARC		●	●		
MANUTENZIONE SPECIFICA PRODUTTORE					●

**ESPAÑOL** **CONSEJOS PARA EL MONTAJE:** **CONSEJOS PARA EL MANTENIMIENTO:**

 NO FUERCE NUNCA EN LAS UNIONES. APRIETE LOS TORNILLOS DESPUES DE CIERTO TIEMPO DE UTILIZACION CONSERVE SU MANUAL DE MONTAJE, SI FALTARA UNA PIEZA. SERIA LA MANERA MAS FACIL DE COMUNICAR CON LA TIENDA.

 NO USE NUNCA PRODUCTOS ABRASIVOS TALES COMO: POLVO DE LIMPIAR, LANA DE ACERO, SOLVENTES. NO MOJAR.

1 > ESTUDE ATENTAMENTE EL MANUAL DE MONTAJE.  
 2 > LOCALICE LAS PIEZAS QUE CONSTITUYEN SU MUEBLE.  
 3 > REUNA Y CONTROLE LOS TORNILLOS.  
 4 > EQUIPE-SE DE LAS HERRAMIENTAS NECESARIAS.  
 5 > PREPARE UNA ZONA DE MONTAJE.  
 6 > REALICE EL MONTAJE.

1 > DESPOLVOREAR CUIDADOSAMENTE.  
 2 > USE UN PAÑO LIMPIO, SUAVE Y HÚMIDO.  
 3 > (MUEBLES DE TELA) PEINE LAS ARRUGAS CAUSADAS POR EL EMBALAJE CON UN CEPILLO.

	PAPEL DE DECORACION	SUPERFICIE ESTRATIFICADAS	SUPERFICIE MAQUEADAS	MADERA BARNIZADA	TEXTIL CUERO
AGUA Y JABON (JABON NEUTRO)	●	●	●	●	●
AGUA CON DETERGENTE		●	●		
MANUTENIMIENTO ESPECIFICO DEL FABRICANTE					●

**HRVATSKA** **UPUTE ZA MONTAŽU:** **UPUTE ZA ODRŽAVANJE:**

 NEMOJTE UPOTREBLJAVATI SILU PRILIKOM SKLAPANJA NAKON NEKOG VREMENA PONOVNO PRITEGNI TE VIKJE ČUVAJTE UPUTE ZA MONTAŽU U SLUČAJU NEODATKA NEKOG DIJELA NAJBLIJE ČE BITI DA DA KONTAKIRATE PRODAJNO MJEŠTO.

 ZABRANJENA JE UPOTREBA KEMIKALIJA ILI BILO O KAKVIH POMOĆNIH SREDSTAVA ZA RIBANJE JARH SREDSTAV ZA ČIŠĆENJE ILI ČELIČNE VUNE NE MOKRA.

1 > PAŽLJIVO PROČITAJTE UPUTE ZA MONTAŽU.  
 2 > PRIPREMITE SVE DIJELOVE NAMJEŠTAJA.  
 3 > PRUKUPITE I PROVJERITE OKOVE ZA MONTAŽU.  
 4 > PRIPREMITE POTREBAN ALAT.  
 5 > PRIPREMITE PROSTOR ZA MONTAŽU.  
 6 > POČINITE MONTIRATI.  
 7 > SAČUVAJTE OVE UPUTE.  
 8 > PROIZVOD JE NAMJENJEN ISKLJUČIVO ZA KUĆNU UPORABU.

1 > PAŽLJIVO OBRISATI PRAŠINU.  
 2 > KORISTITE ČISTU, MEKU, VLAŽNU KRPU.  
 3 > (NAMJEŠTAJ OD TKANINE) KISTOM ČEŠLJAJTE BORE NASTALE NA PAKIRANJU.

	PAPIR	LAMINAT	LAK	DRVO	TEKSTIL KOŽA
OTPINA SAPUNA	●	●	●	●	●
OTPINA SAPUNA		●	●		
NAMIJENSKA SREDSTVA					●

**TÜRKÇE** **MONTAJ TALİMATLARI:** **BAKIM TALİMATLARI:**

 MONTAJLARI ZORLAMAYINIZ BİRKAÇ KULLANIMDAN SONRA VIDALARI SIKIŞTIRINIZ BİR PARÇANIN KAYBOLMASI DURUMUNDA MAĞAZANIZLADAHIA KOLAY İLETİŞİME GEÇEBİLMEYİNİZ (ÇİN MONTAJ KULLANIM TALİMATINIZI SAKLAYINIZ.

 ASLA AŞINDIRICI ÜRÜNLER KULLANMAYINIZ. ÇELİK YÜZÜ SOLVENT BOL SUYLA YIKAMAYINIZ.

1 > MONTAJ TALİMATI YA ZARFI DİKKATLİCE OKUYUNUZ.  
 2 > MOBİL YANIZI OLUŞTURAN PARÇALARI KARETLEVINIZ.  
 3 > HİRDAVATLARI İÇİLE PARÇALARI BİR ARAYA TOPLAYIP KONTROL EDİNİZ.  
 4 > GEREKEN ARAC VE GEREK TEDARIK EDİNİZ.  
 5 > (KENDİNİZE) BİR MONTAJ ALANI EDİNİNİZ.  
 6 > MONTE ELMEYE BAŞLAYINIZ.

1 > TOZLUNU DİKKATLİCE ALINIZ.  
 2 > TEMİZ, YUMUŞAK, NEMLİ BİR BEZ KULLANIN.  
 3 > (NAMJEŞTAJ OD TKANINE) KISTOM ÇEŞLJAJTE BORE NASTALE NA FIRÇA İLE TARAKEYINIZ.

	SÜS KAGIDI	KATMAN YÜZEY	LAKE YÜZEY	LAKE YÜZEY	TEKSTİL DERİ
SABUNLU SU (NOTR SABUN)	●	●	●	●	●
DETERJAN KATLI MIŞ SU		●	●		
ÜRETİCİYE ÖZGÜ BAKIM					●

**SRBIJA** **SAVETI ZA MONTAŽU:** **UPUTSTVA ZA ODRŽAVANJE:**

 NEMOJTE UPOTREBLJAVATI SILU PRILIKOM SKLAPANJA NAKON NEKOG VREMENA PONOVO PRITEGNI ŠRAFOVE, ČUVAJTE UPUTSTVA ZA MONTAŽU U SLUČAJU NEODATKA NEKOG DIJELA. NAJBLIJE JE DA KONTAKIRATE PRODAJNO MJEŠTO.

 ZABRANJENA UPOTREBA HEMIKALIJA ILI BILO O KAKVIH POMOĆNIH SREDSTAVA ZA RIBANJE JARH SREDSTAV ZA ČIŠĆENJE ILI ČELIČNE VUNE NE MOKRA.

1 > PAŽLJIVO PROČITAJTE UPUTSTVA ZA MONTAŽU.  
 2 > PROVJERITE DA LI IMATE SVE DELOVE.  
 3 > SAKUPITE I PROVJERITE OKOVE ZA MONTAŽU.  
 4 > PRIPREMITE POTREBAN ALAT.  
 5 > PRIPREMITE PROSTOR ZA MONTAŽU.  
 6 > POČINTE DA MONTIRATE.  
 7 > SAČUVAJTE OVA UPUTSTVA.  
 8 > PROIZVOD JE NAMJENJEN ISKLJUČIVO ZA KUĆNU UPOTREBU.

1 > PAŽLJIVO OBRISATI PRAŠINU.  
 2 > KORISTITE ČISTU, MEKU, VLAŽNU KRPU.  
 3 > (NAMJEŠTAJ OD TKANINE) KISTOM ČEŠLJAJTE BORE NASTALE NA PAKIRANJU.

	HARTIJA	LAMINAT	LAK	DRVO	TEKSTIL KOŽA
RASTVOR SAPUNA	●	●	●	●	●
RASTVOR DETERDŽENTA		●	●		
NAMIJENSKA SREDSTVA					●