

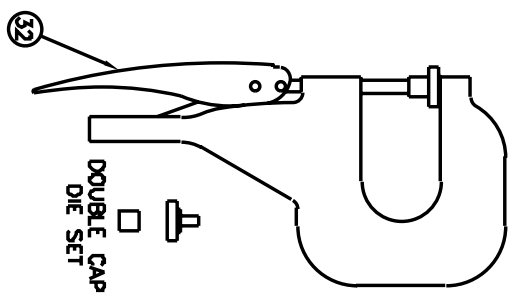

# FAST-FOLD® DELUXE REPLACEMENT PARTS

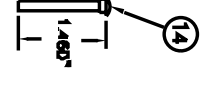
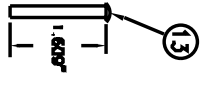
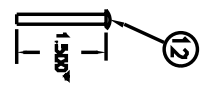
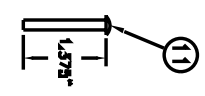
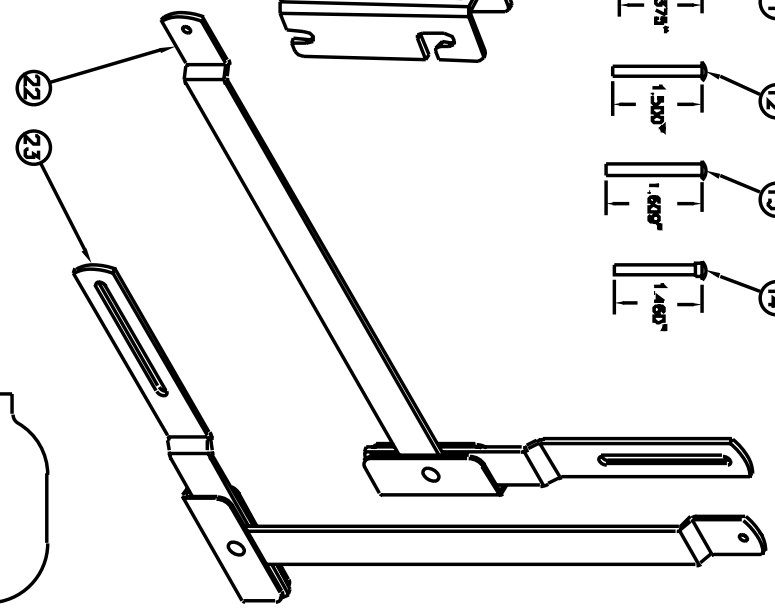
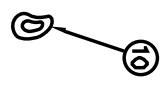
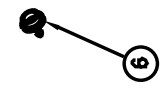
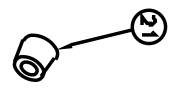
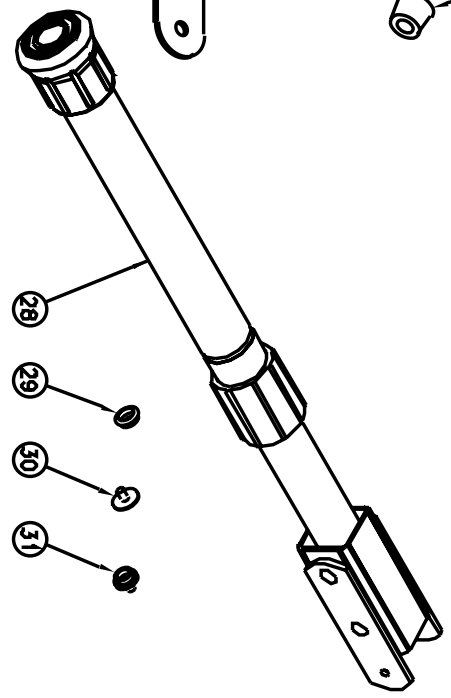
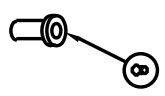
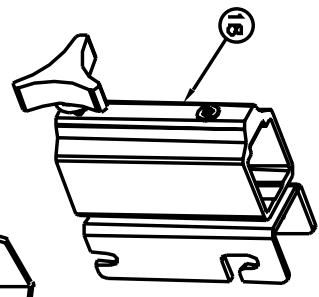
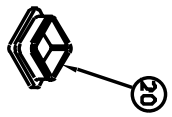
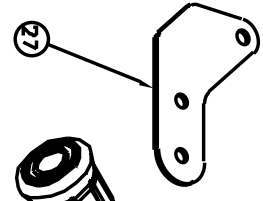
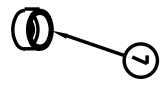
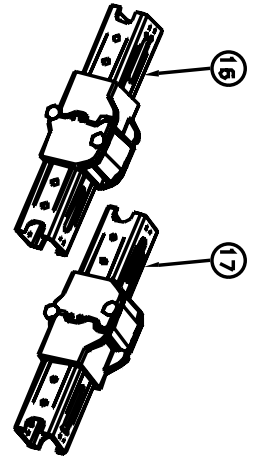
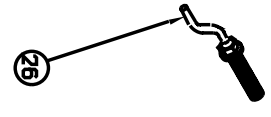
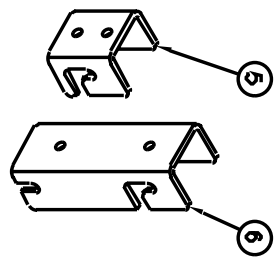
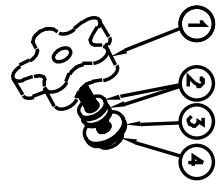
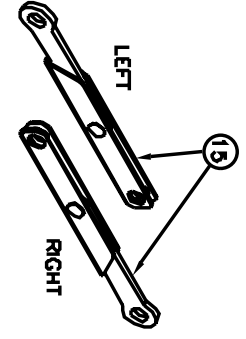
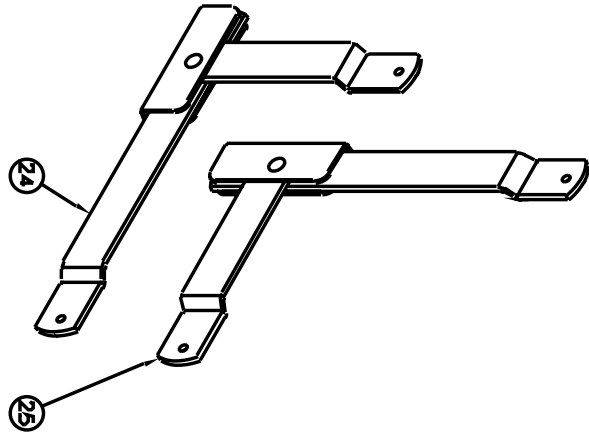

## FAST-FOLD® DELUXE REPLACEMENT PARTS

Diagram No.	Da-Lite Part No.	Description	Quantity Required	List Price Each
1	47274	Knob - used on T-Legs for tilt	1	\$4.00
2	47352	Washer, flat .625OD x .265ID x .047T - used as a spacer on T-Legs	2	0.34
3	44842	Washer, flat .921OD x .468ID x .062T - used as a spacer on T-Legs	1	0.34
4	93816	Carriage bolt, 1/4 - 20 x 2.25" - used on T-legs for tilt	1	0.12
5	89179AN	Short hanger for wing arms	2	7.80
6	89178AN	Long hanger for valance bar, wing bar and skirt bar sliders	2	12.80
7	90982	Rivnut spacer - used between frame and legs	varies	0.66
8	47473	Rivnut, steel 5/16-18 long - used on frame for speedy cranks	4-10	2.80
9	47441	Snap stud - mounts to frame to snap fabric onto frame	varies	0.60
10	44829	Washer, spring .563OD x .195ID x .008T - used in leg brace assembly	1	0.24
11	44830	Rivet, .187 x 1.375" long - used to mount hinge/latch assy. to frame	varies	0.26
12	88801	Rivet, .187 x 1.500" long - used to mount corner hinge plate to frame	16	0.72
13	88802	Rivet, .186 x 1.609" long - used for corner hinge plate assy.	4	0.38
14	88901	Rivet, shoulder .238 x 1.504" long - mounts to frame to hook Dressup hardware	10	0.48
15	35215L	Corner brace assy., left - used on the frame	2	15.00
	35215R	Corner brace assy., right - used on the frame	2	15.00
16	36234	Right hinge/latch assy. - used on frame	varies	11.60
17	36240	Left hinge/latch assy. - used on frame	varies	11.60
18	89175	Skirt bar slider for adjustable skirt bar only	2	39.80
19	35167	Rivnut, hex steel 5/16 - 18 long - used for bottom two holes for #7	2	4.40
20	88599	Plastic plug, 1.25" square - used on frame and legs	varies	0.54
21	47353	Rubber foot for legs and dress up kit hardware	2-6	0.48
22	58644	Right leg brace assembly for T-Legs	2	17.40
23	58648	Left leg brace assembly for T-Legs	2	17.40
24	58659	Right corner brace assembly for leg assy.	2	15.20
25	58660	Left corner brace assembly for leg assy.	2	15.20
26	89196	Speedy crank, 2.69"	varies	5.50
27	91029PL	Corner hinge plate - used to join frame corner	8	0.72
28	89704	Skirt bar steadyrest assembly for 10' or wider skirt with skirt bar	1	46.00
	89705	Skirt bar steadyrest assembly for extra long skirt with skirt bar	1	46.00
29	47489	Light socket for all fabric snaps except corners	varies	0.36
	47490	Heavy socket for dress up kits and corners, black	varies	0.36
30	47491	Black cap - used on three sides of fabrics and dress up kits	varies	0.36
31	47492	Double cap - used at the bottom of all fabrics	varies	0.36
32	76781	Snap tool - used to replace both types of snaps	1	294.00



## FAST-FOLD® DELUXE FRAME REPAIR KIT

Diagram No.	Da-Lite Part No.	Description	Quantity Required	List Price Each
1	89877	Right latch assy., used on frame and legs (Prior to 6/08)	5	\$11.60
	36234	Right hinge/latch assy., used on frame and legs	5	11.60
2	89876	Left latch assy., used on frame and legs (Prior to 6/08)	5	11.60
	36240	Left hinge/latch assy., used on frame and legs	5	11.60
3	47473	Rivnut, steel 5/16-18 long - used on frame for speedy cranks	10	2.80
4	88801	Rivet, .187 x 1.500" long - used to mount corner hinge plate to frame	8	0.72
5	88901	Rivet, shoulder .238 x 1.504" long - mounts to frame to hook Dressup hardware	10	0.48
6	88802	Rivet, .186 x 1.609" long - used for corner hinge plate assy.	4	0.38
7	94079	Rivet, .200 x 1.676" long - used to mount latch assy. to frame (Prior to 6/08)	40	0.58
	44830	Rivet, .187 x 1.375" long - used to mount latch assy. to frame	40	0.26
8	44812	Spring washer - used in corner hinge plate assy., beneath corner hinge plates	10	0.34
9	47441	Snap stud - mounts to frame to snap fabric onto frame	20	0.60
10	47206	Rivet setting tool	1	90.00
11	91029PL	Corner hinge plate - used to join frame corner	10	0.72
12	47207	Rivnut tool	1	188.00
13	88807	Spacer, .250OD x .194ID x 1.25" long - used in latch assy. (Prior to 6/08)	10	1.30
14	88806	Spring - used in latch assy., beneath the blue latch (Prior to 6/08)	20	0.72
<b>For complete Deluxe Frame repair kit, order as follows:</b>				
	89875	Fast-Fold Deluxe Frame Repair Kit (Prior to 6/08) (includes #1-14)	1	476.00
	36975	Fast-Fold Deluxe Frame Repair Kit (includes #1-12)	1	476.00