

Mission Style End Table

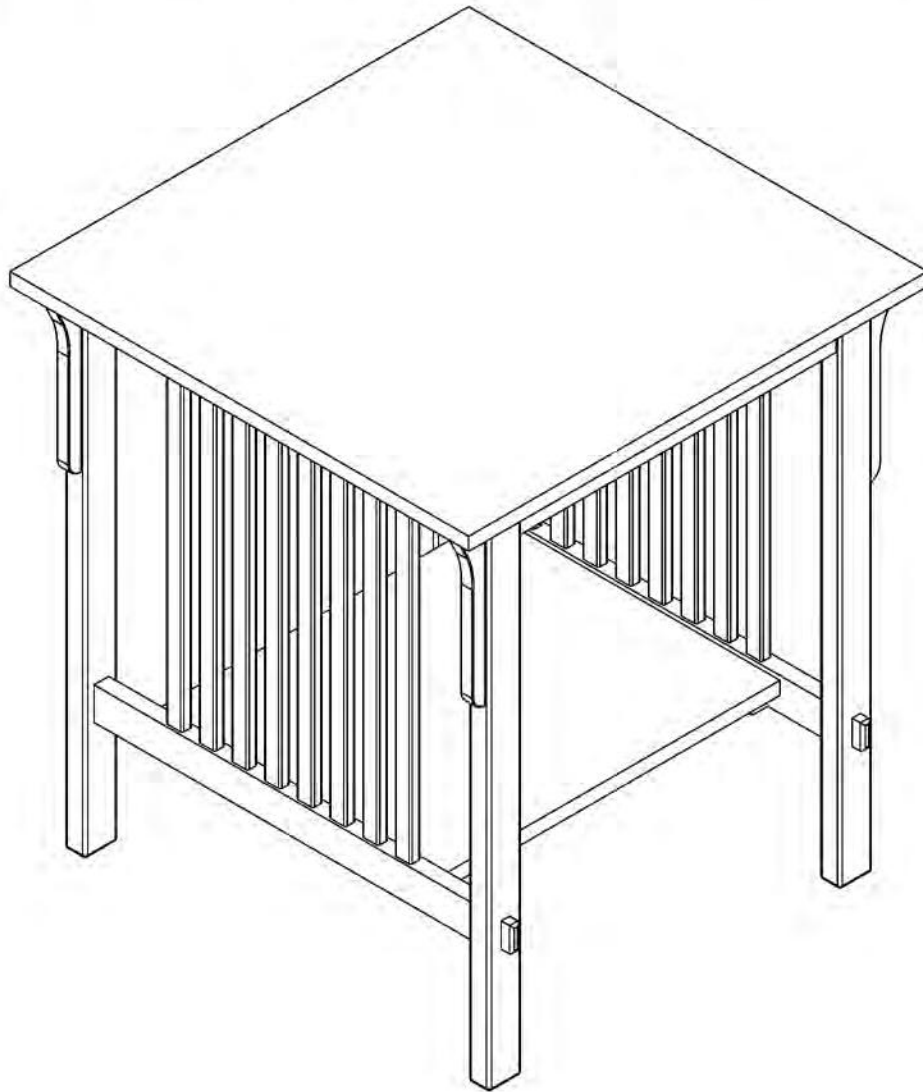

Assembly Instructions

This item has been manufactured from high quality materials for home use.

Please read this manual and familiarize yourself with all the parts prior to assembly.

Follow each step as shown

Keep your furniture free from dust

Wipe surfaces with a clean, lint free cloth.

Use only a mild furniture polish to retain the wood's luster and finish.

Do not place anything with a rough or wet bottom directly on the table as scratches and or "water rings" may occur.

Occasionally check and tighten leg and drawer hardware.

Never "drag" or pull your furniture across the floor, always (and with the help of another person) lift your furniture and place it where you want it.

Part List

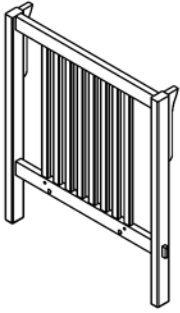

Ⓐ 2PCS
PANELS

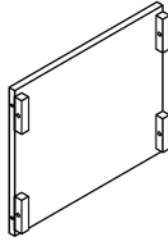

Ⓑ 1PC
BOTTOM SHELF

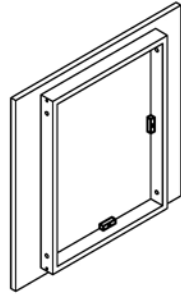

Ⓒ 1PC
TOP SHELF

Hardware

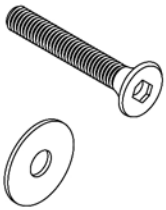

① 4SETS
BLOTS

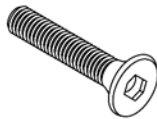

② 4PCS
BOLTS



③ 8PCS
DOWELS



④ 1PC
ALLEN WTENCH

Assembly Instructions

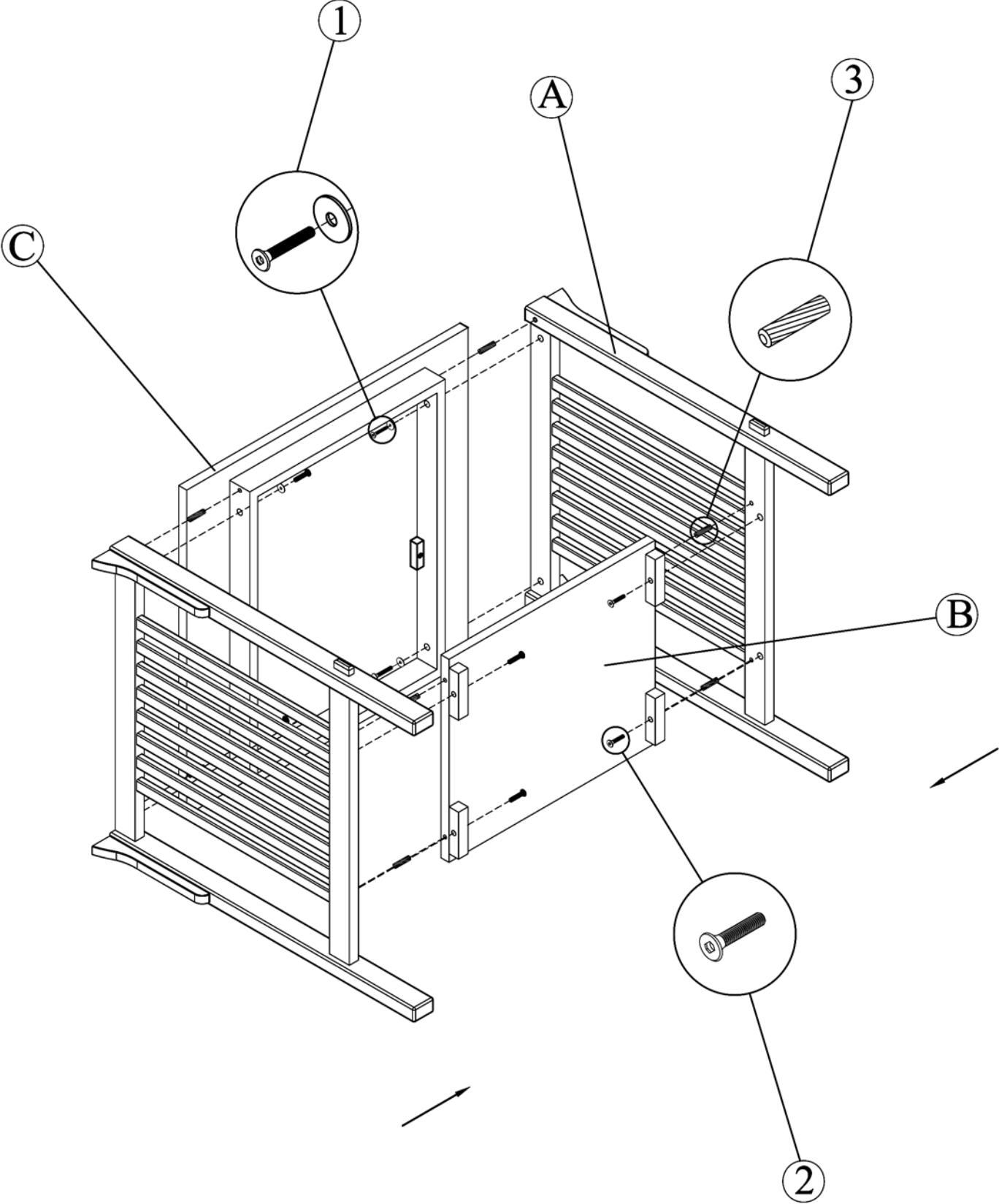

Limited Warranty