

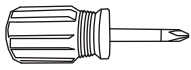

### Component List

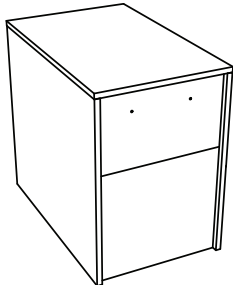

**A** - Phillips Screwdriver  
x 1 (not provided)



**B** - Cabinet x 1

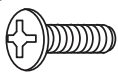

**C** - 5/32" x 12mm  
Phillips Screw  
x 20

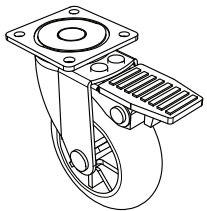

**D** - Brake Caster x 4

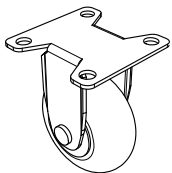

**E** - Center Caster x 1

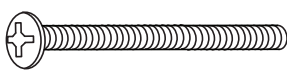

**F** - M4 x 37mm  
Phillips Screw  
x 2

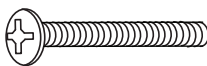

**G** - M4 x 25mm  
Phillips Screw  
x 2

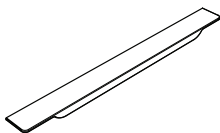

**H** - Pull x 2

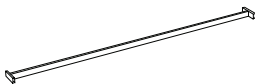

**I** - Letter File Bar x 2

Format is engineered for easy assembly. Carefully follow this procedure to prevent any damage.

**Do not use power tools for assembly of this product.**



### Placement and Maintenance

Format™ Office furniture is designed for indoor use on level floors. Clean steel parts and wood veneer with a moist cloth.

### Step 1

#### Unpack and Identify

Unpack and identify the components at left. Note that some components are shipped inside the cabinet. The assembly workspace should be a non-marring surface such as carpet. For missing hardware pieces, please contact BDI Customer Service at customerservice@bdiusa.com. For all other concerns, please contact your BDI Retailer.

### Step 2

#### Install Casters

Carefully position **Cabinet (B)** on its back side so that bottom side is accessible, then attach a **Caster** at each of the five (5) exposed installation plates using **5/32" x 12mm Phillips Screw (C)** and a Phillips Screwdriver.

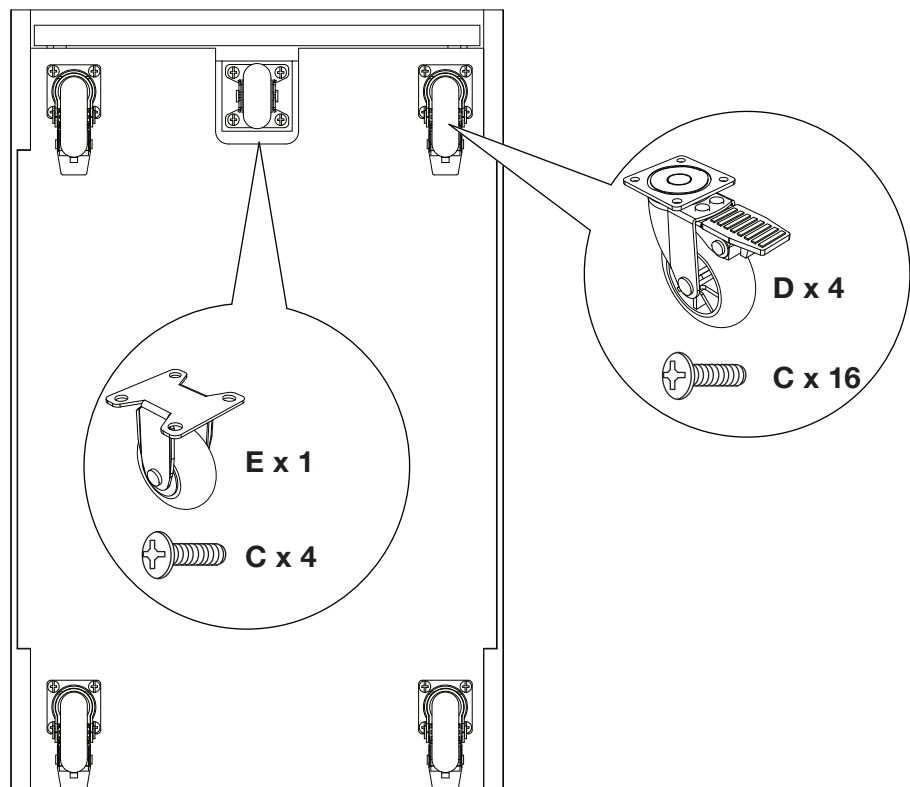

**Step 3**  
**Install Drawer Pulls.**  
**Install Pulls.**

Carefully turn pedestal upright and then install **Pull (H)** to top drawer using the **M4 x 37mm Phillips Screw (F)** and a Phillips Screwdriver. Install **Pull (H)** to bottom drawer using the **M4 x 25mm Phillips Screw (G)** and a Phillips Screwdriver.

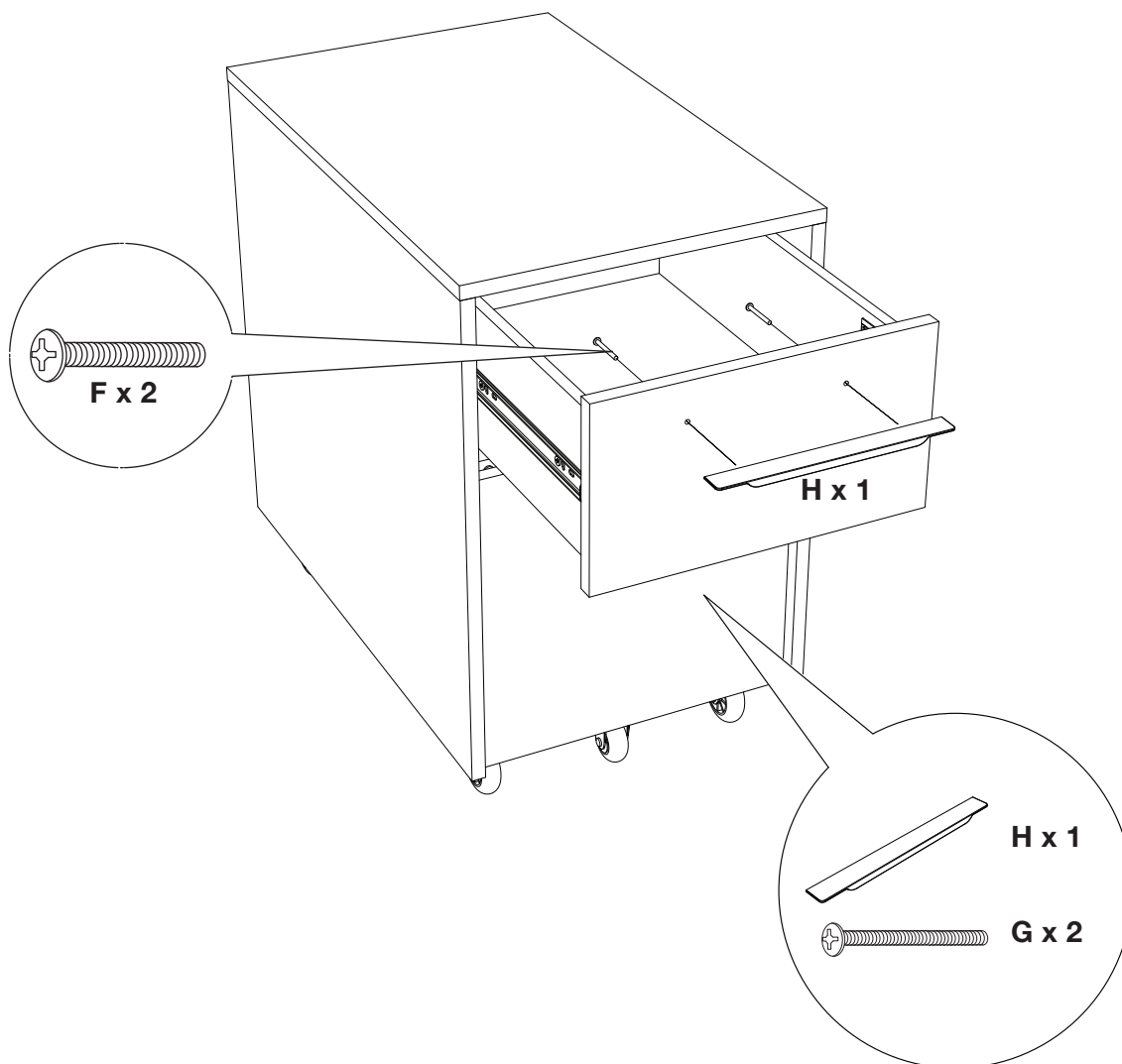

**Step 4**  
**File Folders**

Users who wish to use legal-length files may install **Letter File Bars(I)** into place near front and back of file drawers.

