

# PRIMO 56" FOOSBALL TABLE ASSEMBLY INSTRUCTIONS



NG1035











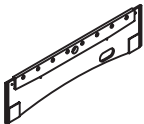
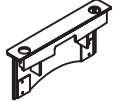
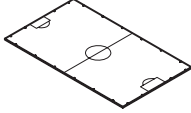

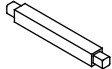

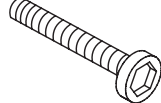
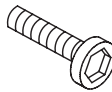

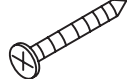
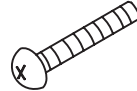
**THANK YOU!**

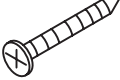
Thank you for purchasing this product.







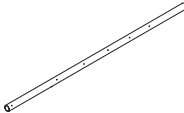

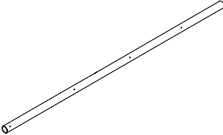
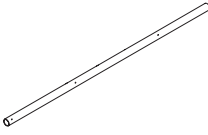

We work around the clock and around the globe to ensure that our products maintain the highest possible quality. However, in the rare instance that your product is defective or missing parts, contact your retailer, or call 800-759-0977, to submit parts requests or warranty claims. Please read the warranty information at the back of these assembly instructions for further details.

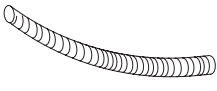
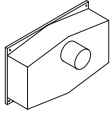
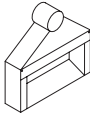
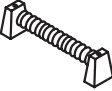
**IMPORTANT! PLEASE READ THESE ASSEMBLY INSTRUCTIONS  
IN ENTIRETY BEFORE ASSEMBLING YOUR PRODUCT.**

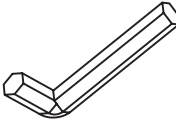
# PARTS IDENTIFIER (NOT TO SCALE)

<p>#1</p>  <p>Side Panel 2 pieces</p>	<p>#2</p>  <p>End Panel 2 pieces</p>	<p>#3</p>  <p>Playing Field 1 piece</p>	<p>#4</p>  <p>Left Leg 2 pieces</p>	<p>#5</p>  <p>Right Leg 2 pieces</p>
<p>#6</p>  <p>Leg Panel 2 pieces</p>	<p>#7</p>  <p>Playfield Support Brace 2 pieces</p>	<p>#8</p>  <p>5/16" Flat Washer 16 pieces</p>	<p>#9</p>  <p>5/16"x35mm Bolt 16 pieces</p>	<p>#10</p>  <p>1/4"x60mm Bolt 8 pieces</p>
<p>#11</p>  <p>1/4" Flat Washer 8 pieces</p>	<p>#12</p>  <p>4X12mm Round Head Screw 28 pieces</p>	<p>#13</p>  <p>4x25mm Flat Head Screw 24 pieces</p>	<p>#14</p>  <p>1-1/8" Bolt 26 pieces</p>	<p>#15</p>  <p>Locknut 26 pieces</p>
<p>#16</p>  <p>4x12mm Flat Head Screw 2 pieces</p>	<p>#17</p>  <p>4x18mm Round Head Screw 4 pieces</p>	<p>#18</p>  <p>4X45mm Round Head Screw 4 pieces</p>	<p>#19</p>  <p>Rod Handle 8 pieces</p>	<p>#20</p>  <p>Rod Washer 16 pieces</p>
<p>#21</p>  <p>Rod Bumper 16 pieces</p>	<p>#22</p>  <p>Visit Player 11 pieces</p>	<p>#23</p>  <p>Home Player 11 pieces</p>	<p>#24</p>  <p>5 Player Rod 2 pieces</p>	

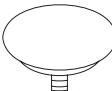
# PARTS IDENTIFIER (NOT TO SCALE)

<p>#25</p>  <p>3 Player Rod 4 pieces</p>	<p>#26</p>  <p>2 Player Rod 2 pieces</p>	<p>#27</p>  <p>Ball Entry Cap 2 pieces</p>	<p>#28</p>  <p>Ball Runner 2 pieces</p>
<p>#29</p>  <p>Side Ball Catcher 2 pieces</p>	<p>#30</p>  <p>Ball Catcher 2 pieces</p>	<p>#31</p>  <p>Manual Scorer 2 pieces</p>	<p>#32</p>  <p>Silver Plastic Cup 4 pieces</p>
<p>#33</p>  <p>Allen Key 1 piece</p>	<p>#34</p>  <p>Soccer Ball 2 pieces</p>	<p>#35</p>  <p>Apron Corner 4 pieces</p>	<p>#36</p>  <p>Rod End cap 8 pieces</p>
<p>#37</p>  <p>Leg Leveler 4 pieces</p>	<p>#38</p>  <p>Stop Ring 4 pieces</p>	<p>#39</p>  <p>5/8" Bolt 8 pieces</p>	

Please see Parts List at end of manual for part number when ordering parts. For replacement parts please call 800-759-0977.

## ASSEMBLY TIPS

1. Find a clean, level surface to begin the assembly of your game table. The table will be partially assembled upside down and then turned over onto its legs. This is a heavy game and turning it over will require at least two strong adults.
2. Remove all of the contents from box and verify that you have all of the parts shown on the Parts Identifier before you begin assembly. **Note: Some parts may be pre-installed or pre-assembled.**
3. Some figures or drawings may not look exactly like your product. Please read and understand the text before beginning each assembly step.
4. **When installing parts that have more than one screw or bolt, hand tighten all screws or bolts in place before finishing tightening with screwdriver or hex wrench.**
5. Electric screwdrivers may be helpful during assembly; however, please set a low torque and use extreme caution because screws may be stripped or overtightened if the electric screwdriver's torque is set too high.

### **WARNINGS!**

READ AND FOLLOW ALL ASSEMBLY, OPERATION AND SAFETY INSTRUCTIONS CAREFULLY.

CHOKER HAZARD - THIS TABLE CONTAINS SMALL BALLS AND PARTS - NOT  
SUITABLE FOR CHILDREN UNDER 3 YEARS OF AGE.

# ASSEMBLY INSTRUCTIONS

1. Place PLAYFIELD #3, with field markings facing down, onto the ledge of the SIDE PANELS #1.  
*Note: The table is assembled upside down.*

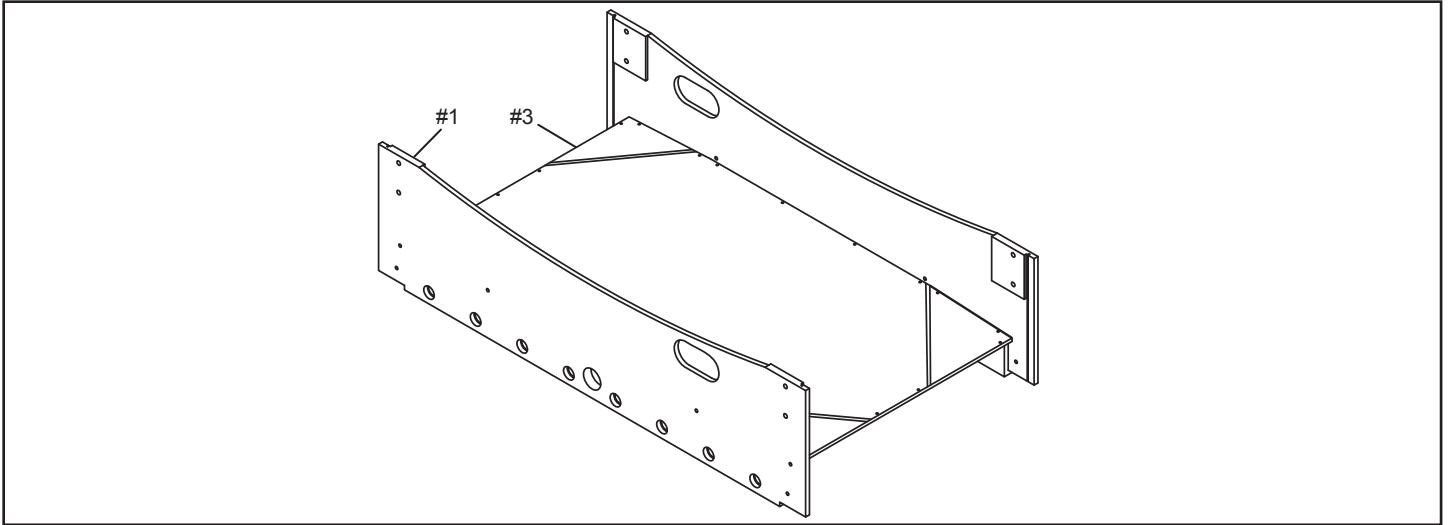

2. Attach one END PANEL #2 to each end of the table with 1/4" BOLT #10 and 1/4" FLAT WASHER #11.  
*Note: DO NOT over tighten bolts. In this step, loosely tighten just until sides touch.*
3. Attach PLAYFIELD to table with 1" FLAT SCREWS #13 around inside edge using pre-drill holes. *Note: ALWAYS use pre-drilled holes. If not, permanent damage can be done to table. A flashlight can be helpful in aligning holes. It may be helpful to have a second person push on the opposite side, as you attach Playfield, in order to square up surface. Make sure End Panels fit snugly against Side Panels before screwing down Playfield.*
4. Insert the APRON CORNERS #35 onto the SIDE PANELS #1 and END PANELS #2 on the four corners.  
*Note: Make sure inside screw holes are positioned at top.*
5. Tighten 1/4" BOLTS #10, loosely tightened in Step 2, on both sides.

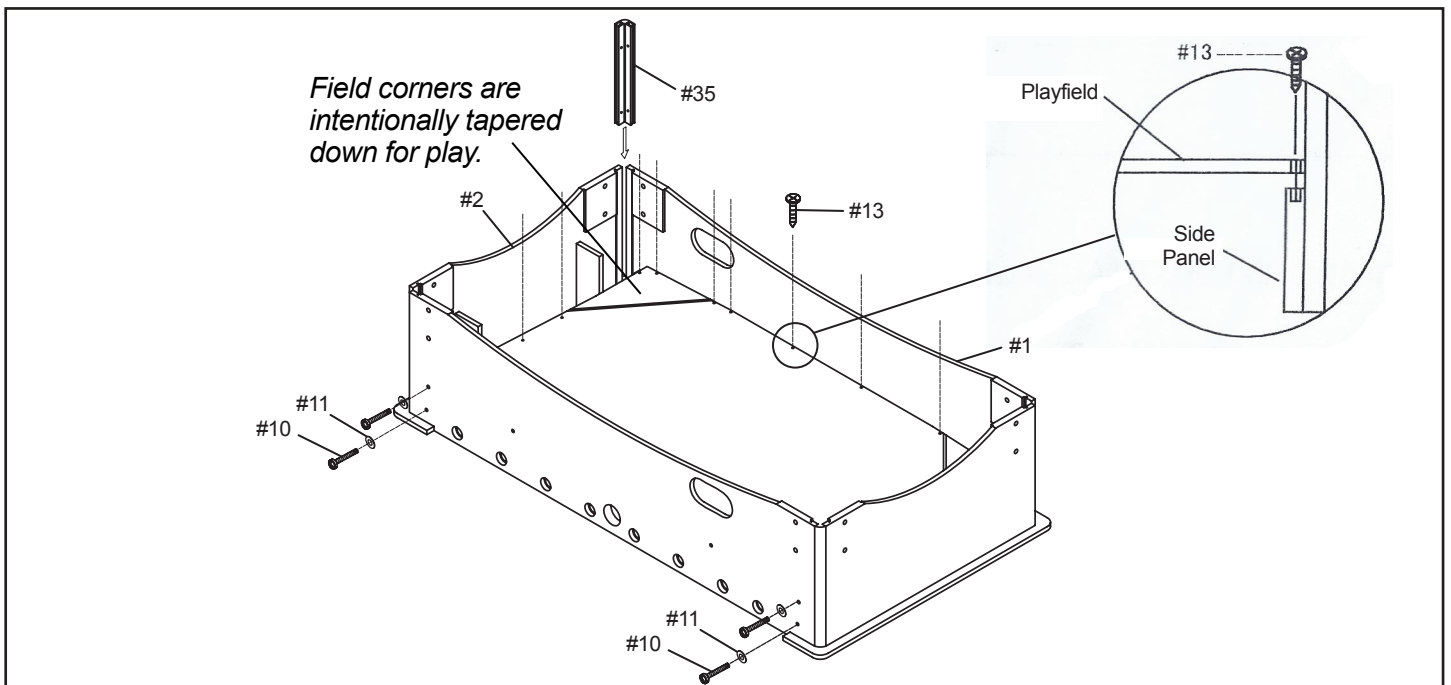

# ASSEMBLY INSTRUCTIONS

5. Position each PLAYFIELD SUPPORT BRACE #7 between the SIDE PANELS as shown below. Attach the SUPPORT BRACE #7 with 1-3/4" SCREW #18. Attach the APRON CORNERS to each corner of the table with 1/2" SCREW #12.

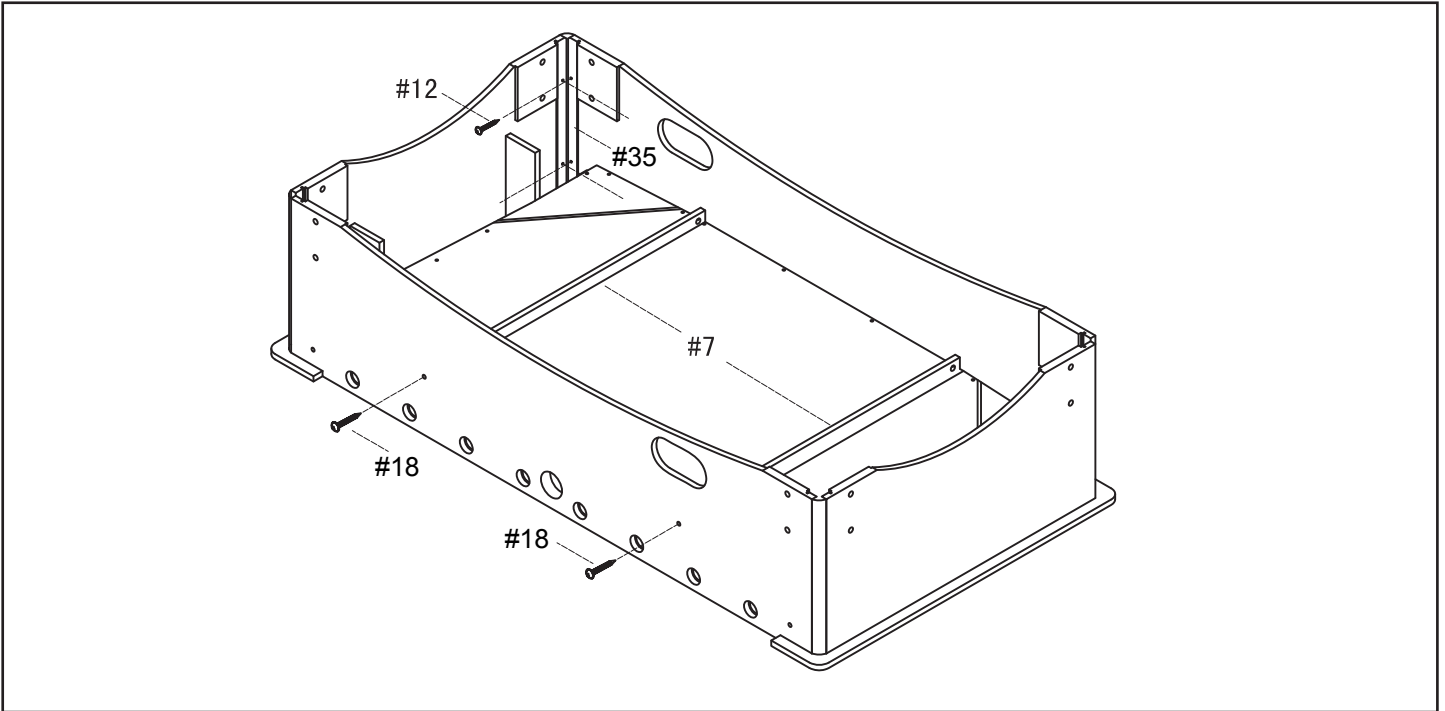

6. Attach the SIDE BALL CATCHER #29 to each of the SIDE PANELS with 1/2" SCREW #12. Attach the BALL CATCHER #30 to each of the END PANELS with 1/2" SCREW #12. Attach the BALL RUNNER #28 onto the SIDE BALL CATCHER and the BALL CATCHER openings as shown below.

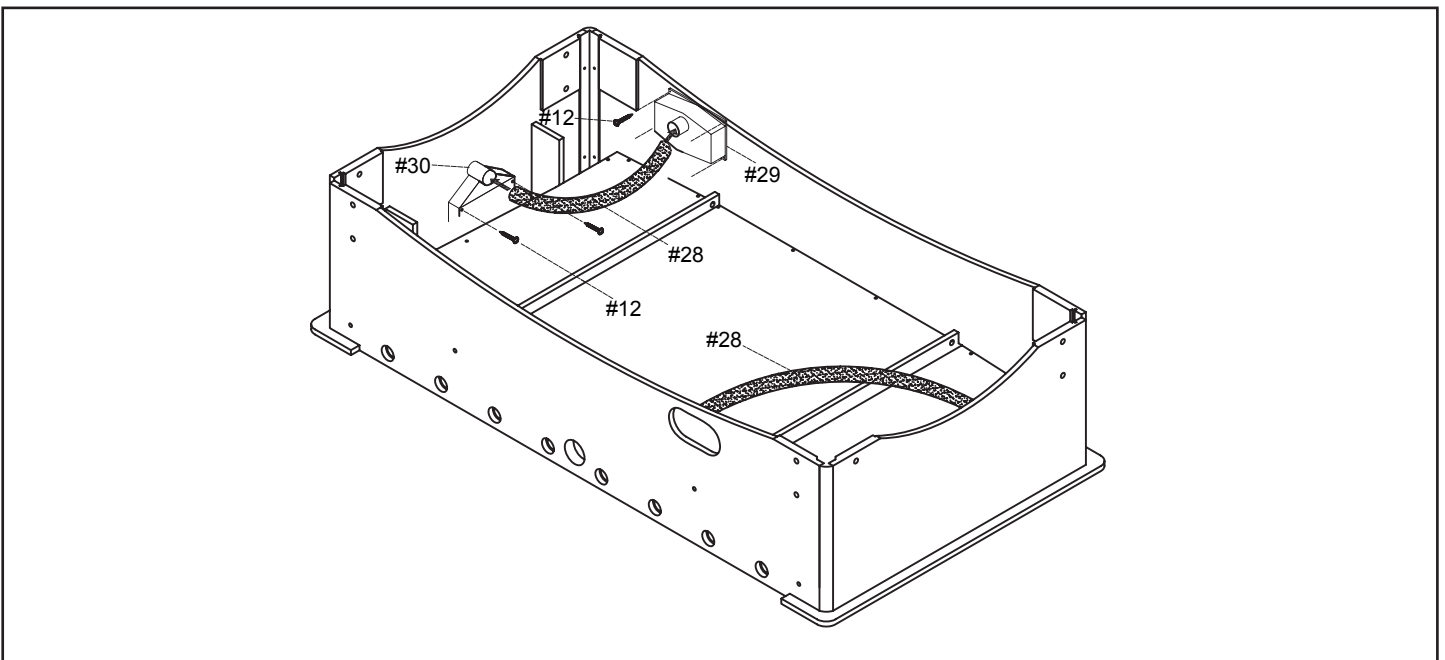

# ASSEMBLY INSTRUCTIONS

7. Insert LEG PANEL #6 into both LEGS as shown. *Note: Chrome strip should face out toward ends.* Attach LEFT LEG #4 and RIGHT LEG #5 to each corner of the table with 5/16" BOLT #9 and 5/16" FLAT WASHER #8.
8. Thread one LEG LEVELER #37 onto each LEG. Carefully turn table over.

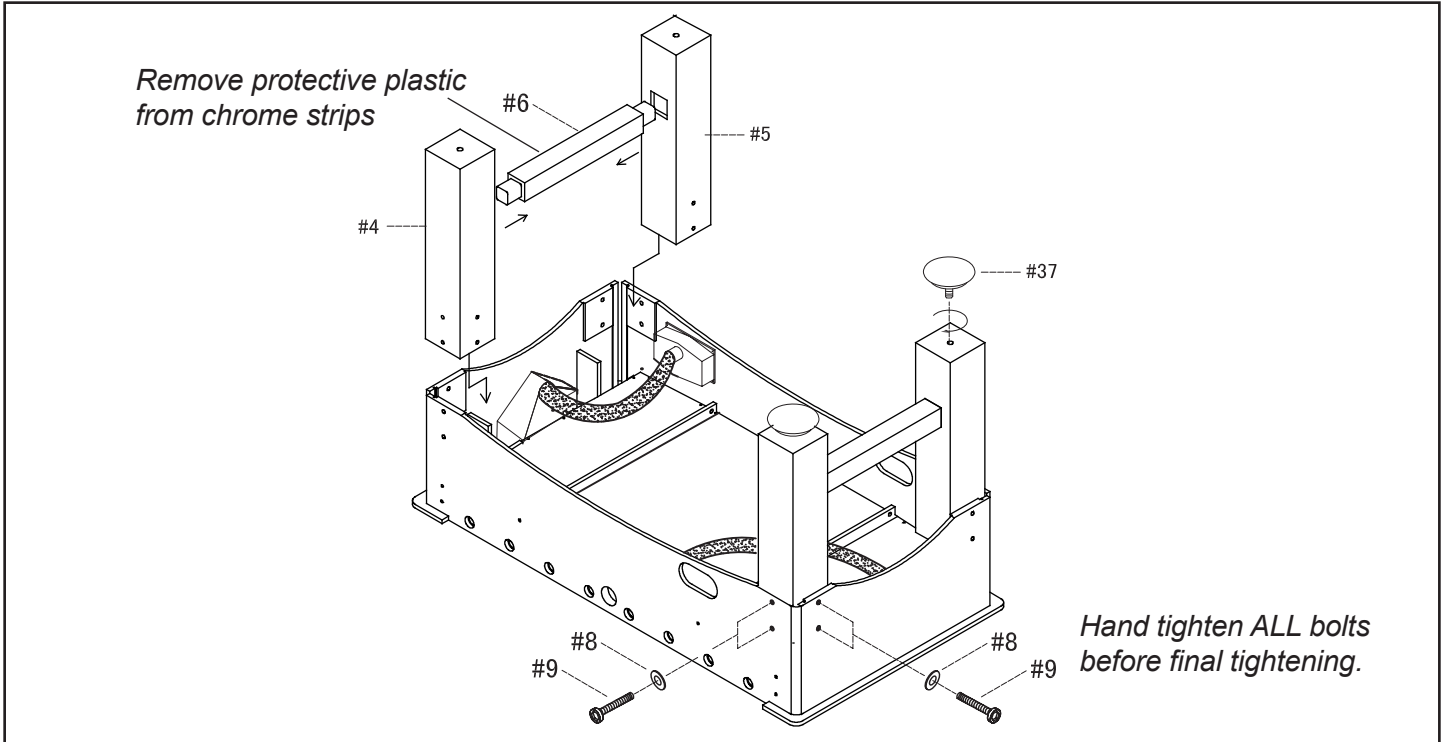

9. Begin PLAYER ROD assembly by partially inserting PLAYER ROD into the appropriate hole in the SIDE PANEL.
10. Before continuing, refer to the diagrams below for correct rod orientation and player placement. *Note: You may choose either color for home or visitor teams.*

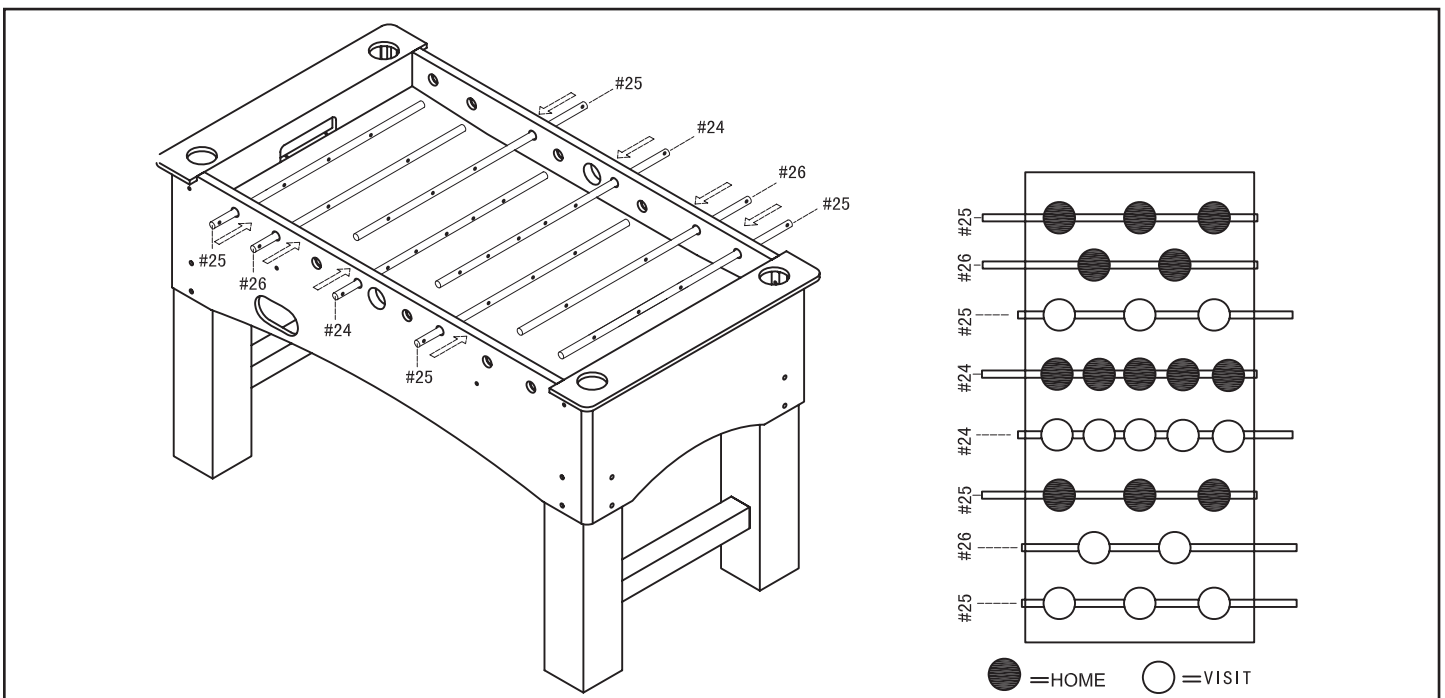



# ASSEMBLY INSTRUCTIONS

11. *Note: the HAND GRIP will be attached to the marked end (with hole) of the PLAYER ROD - this end must be inserted into the SIDE PANEL first.* Slide one RUBBER BUMPER #21 and PLASTIC ROD WASHER #20 onto the partially inserted PLAYER ROD. Slide the appropriate quantity and color of players onto the PLAYER ROD. Finish PLAYER ROD assembly with PLASTIC ROD WASHER #20 and RUBBER BUMPER #21 (note position for each in diagram below). Insert PLAYER ROD into hole on opposite SIDE PANEL. Fasten PLAYERS to PLAYER ROD with 1-1/8" BOLT #14 and LOCKNUT #15.

**Note: STOP RINGS #38 will be used instead of PLAYERS on either side of the goalies and attached to PLAYER RODS with 1" BOLT #14 (these 4 bolts are slightly shorter than other #14 bolts) and LOCKNUT #15.**

12. Repeat assembly with remaining PLAYER RODS. *Note: Each team should face the opposite goal.*

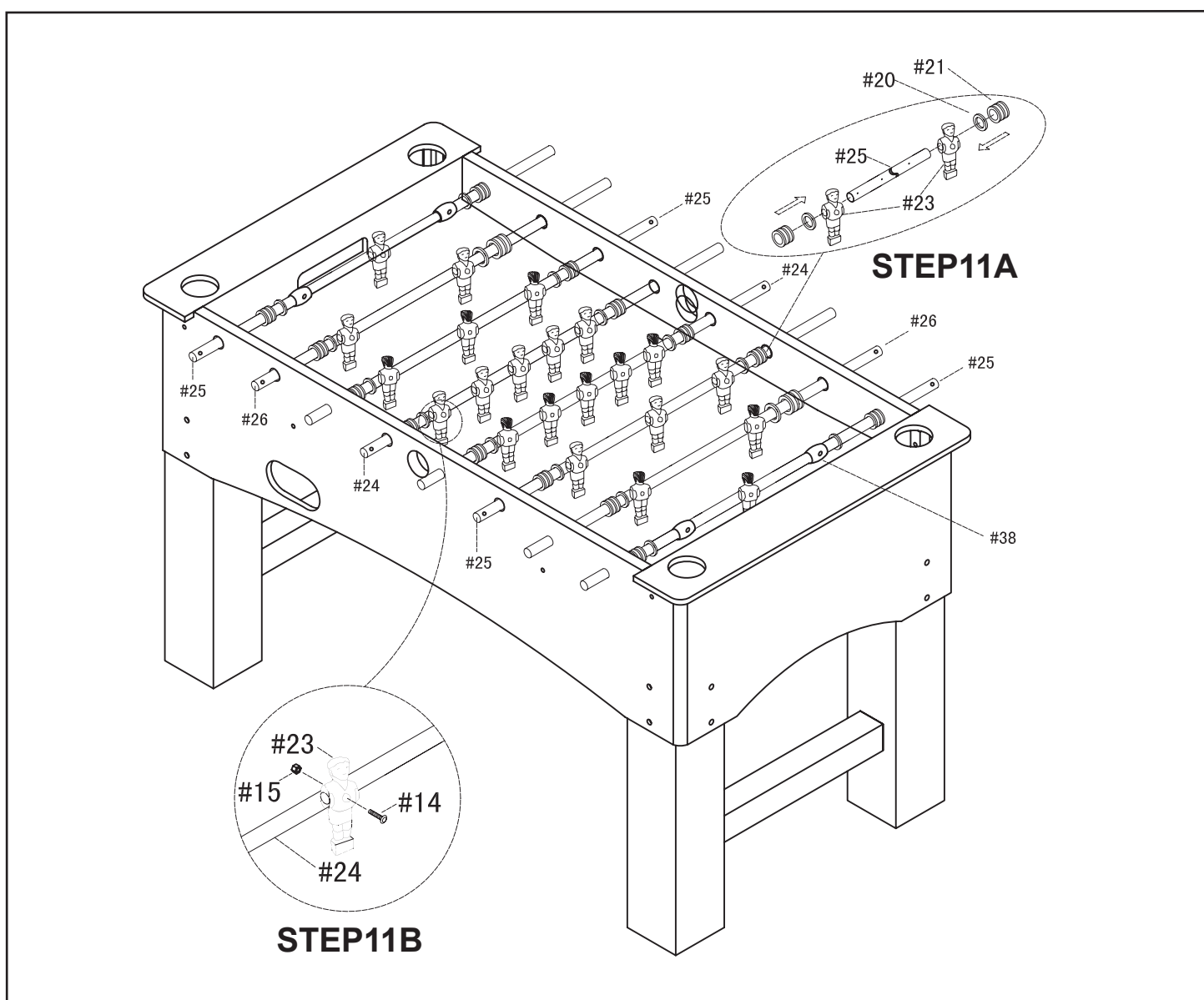

# ASSEMBLY INSTRUCTIONS

13. Attach HAND GRIP #19 to the end of the PLAYER ROD with threaded hole using 5/8" BOLT #39. Attach ROD END CAP #36 to the opposite end.
14. Attach one MANUAL SCORER #31 to the top of each END PANEL with 3/4" ROUND HEAD SCREW #17.
15. Attach one TWO-PIECE BALL LAUNCHER #27 to each side of the table by inserting the cup into the hole on the outside of the SIDE PANEL and the launcher into the hole on the inside of the SIDE PANEL and screwing them together. Fasten each to the table with one 1/2" FLAT SCREW #16.
16. Insert SILVER CUP HOLDERS #32 into the holes in the top of each END PANEL as shown.

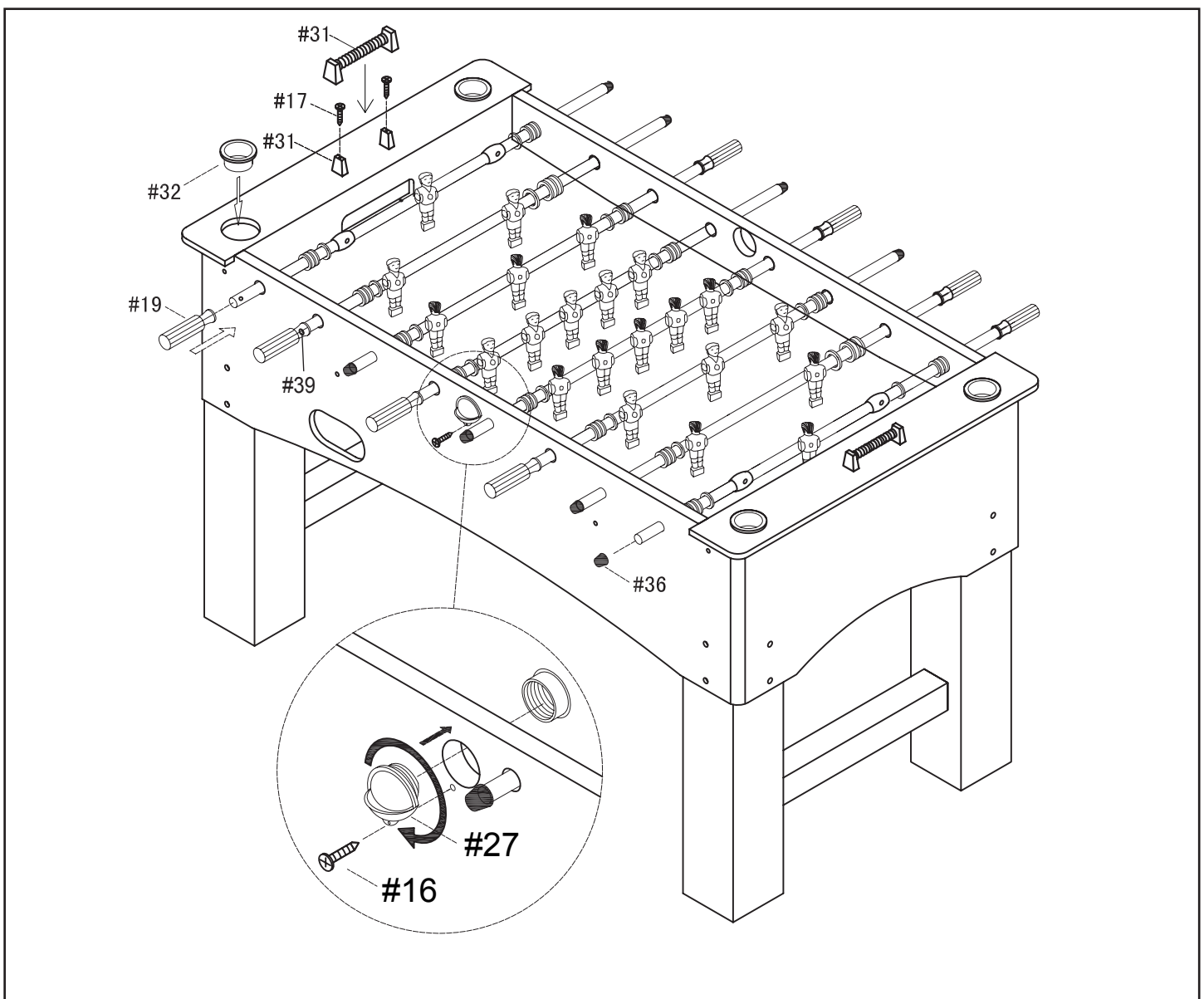

**CONGRATULATIONS!**

You have now assembled your Soccer Table. Please note the Care and Use instructions below to ensure years of trouble free use of your game table.

### **CARE AND USE**

1. This product is intended for INDOOR use only.
2. Do NOT sit, climb or lean on the table.
3. Do NOT drag the table when moving it as this will damage the legs.

# 180-DAY LIMITED WARRANTY

This product is warranted to the original purchaser to be free from defects in material or workmanship for a period of 180 days from the date of the original retail purchase.

This warranty does not cover defects or damage due to improper installation, alteration, accident or any other event beyond the control of the manufacturer. Defects or damage resulting from misuse, abuse or negligence will void this warranty. This warranty does not cover scratching or damage that may result from normal usage.

This product is not intended for institutional or commercial use; the manufacturer does not assume any liability for such use. Institutional or commercial use will void this warranty.

This warranty is nontransferable and is expressly limited to the repair or replacement of the defective product. During the warranty period, the manufacturer shall repair or replace defective parts at no cost to the purchaser. Shipping charges and insurance are not covered and are the responsibility of the purchaser. Labor charges and related expenses for removal, installation or replacement of the product or components are not covered under this warranty.

The manufacturer reserves the right to make substitutions to warranty claims if parts are unavailable or obsolete.

The manufacturer shall not be liable for loss of use of the product or other consequential or incidental costs, expenses or damages incurred by the consumer of any other use. The user assumes all risk of injury resulting from the use of this product.

This warranty is expressly in lieu of all other warranties, expressed or implied, including warranties of merchantability or fitness for use to the extent permitted by Federal or state law. Neither the manufacturer nor any of its representatives assumes any other liability in connection with this product.

**All warranty claims must be made through the retailer where the product was originally purchased. A purchase receipt or other proof of date of purchase will be required to process all warranty claims. The model number and part numbers found within the assembly instructions will be required when submitting any parts requests or warranty claims.**







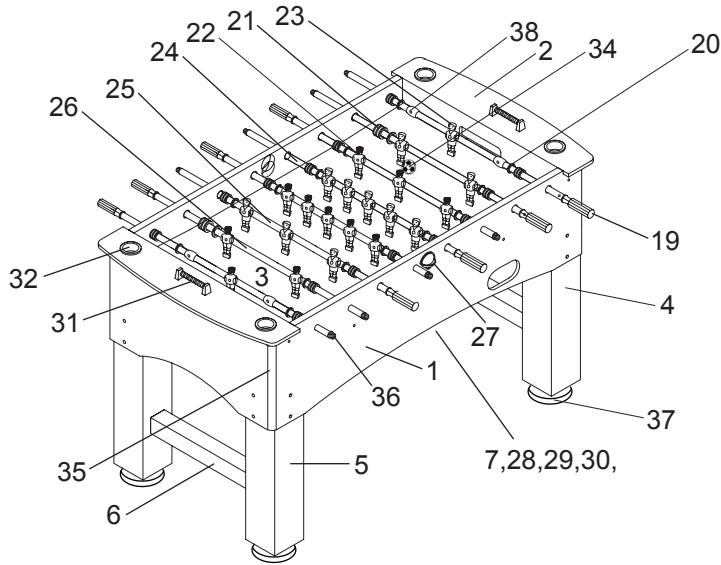



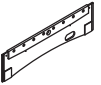
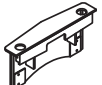
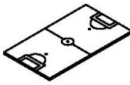

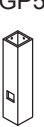











**For further warranty information or inquiries, please call 800-759-0977**

# PRIMO 56" FOOSBALL TABLE - NG1035

## Parts List















### PARTS

#1 NGP5786  SIDE PANEL	#2 NGP5787  END PANEL	#3 NGP5788  PLAYFIELD	#4 NGP5789  LEG - LEFT	#5 NGP5790  LEG - RIGHT	#6 NGP5791  LEG PANEL	#7 NGP5792  PLAYFIELD SUPPORT BRACE
#19 NGP57931  HAND GRIP	#20 NGP5794  PLASTIC ROD WASHER	#21 NGP5795  RUBBER BUMPER	#22 NGP5796  AWAY PLAYER	#23 NGP5797  HOME PLAYER	#24 NGP5798  5 PLAYER ROD	#25 NGP5799  3 PLAYER ROD
#26 NGP5800  2 PLAYER ROD	#27 NGP5801  2 PIECE BALL LAUNCHER	#28 NGP5802  BALL RUNNER	#29 NG5803  SIDE BALL CATCHER	#30 NG5804  BALL CATCHER	#31 NG5805  MANUAL SCORER	#32 NG58061  SILVER METAL CUP
#34 NGP5807  SOCCER BALL	#35 NGP5808  APRON CORNER	#36 NGP5809  ROD END CAP	#37 NG5810  LEG LEVELER	#38 NG5811  STOP RING		

11/13

### HARDWARE PACK - NGP5812

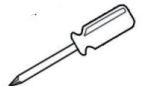
#8  5/16" FLAT WASHER	#9  5/16" BOLT	#10  1/4" BOLT	#11  1/4" FLAT WASHER	#12  1/2" SCREW	#13  1" FLAT SCREW	#14  1-1/8" BOLT
#15  LOCKNUT	#16  1/2" FLAT SCREW	#17  3/4" SCREW	#18  1-3/4" SCREW	#33  HEX WRENCH	#39  5/8" BOLT	ADDITIONAL EQUIPMENT REQUIRED:  PHILLIPS HEAD SCREWDRIVER