



We strive to ensure that our products are of the highest quality and free of manufacturing defects or missing parts. However, if you have any problems with your new product,

**DO NOT RETURN IT TO THE STORE,**

please contact us toll free @:

**1-888-996-2729**

**FAX: 1-866-873-3531**

**gameroom@escaladesports.com**

Or write to:

Escalade Sports

Customer Service Department

P.O. Box 889

Evansville, IN 47706

Please visit our Web site at:

**www.escaladesports.com**

Please have your date code when inquiring about parts.

When contacting Escalade Sports please provide your model number, date code (if applicable), and part number if requesting a replacement part. These numbers are located on the product, packaging, and in this owners manual.

Your Model Number FT200

Date Code: 2 - FT200 - MW

Purchase Date: \_\_\_\_\_

**PLEASE RETAIN THIS INSTRUCTION MANUAL FOR FUTURE REFERENCE**

**IMPORTANT! READ EACH STEP  
IN THIS MANUAL BEFORE YOU  
BEGIN THE ASSEMBLY.**

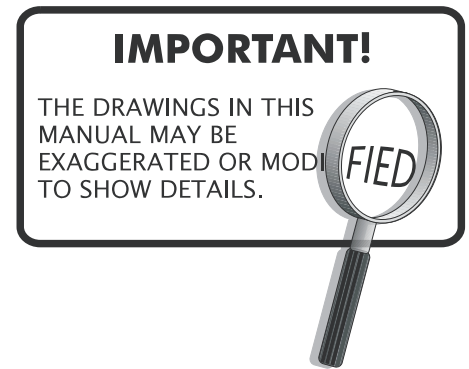

## TWO ADULTS ARE REQUIRED TO ASSEMBLE THIS FT200 SOCCER TABLE

### Tools Required:

- A2 & A3 - Allen Wrench (Included)
- Phillips Screwdriver
- Furniture Polish and Cloth

**An electric screwdriver is helpful in assembly. However, please set at low torque and use extreme caution with an electric screwdriver because you could overtighten the hardware and strip the screws.**





## Assembly Tips

Make sure you understand the following tips before you begin to assemble your soccer table.

1. Start all bolts by hand before tightening.
2. Some drawings or images in this manual may not look exactly like your product. Please read and understand the text before starting each assembly step.

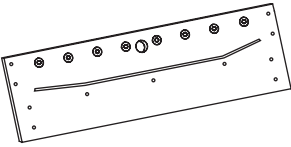
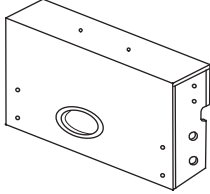
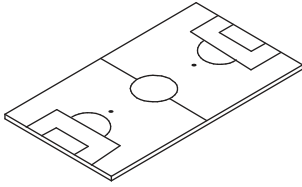
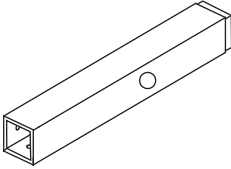
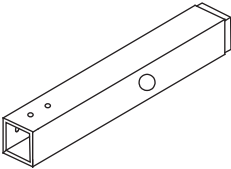
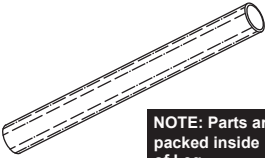
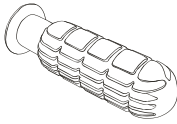
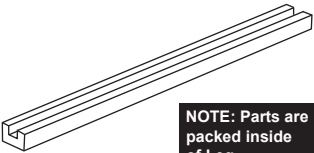
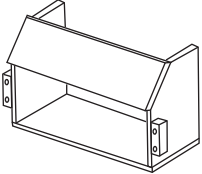

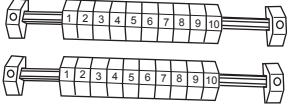
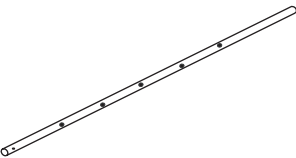
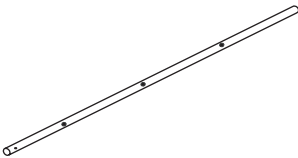
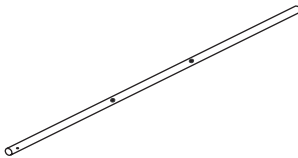
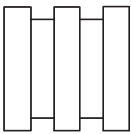
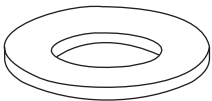
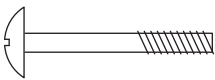



### **WARNING:**

**READ AND FOLLOW ALL ASSEMBLY, OPERATION, AND  
SAFETY INSTRUCTIONS CAREFULLY. AT LEAST TWO  
ADULTS ARE NEEDED TO PUT THIS SOCCER TABLE  
TOGETHER.**

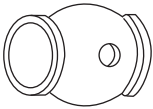
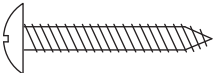
<p>P1 = 2 pcs Side Apron</p>  <p>RPFT20-P1</p>	<p>P2 = 2 pcs End Apron</p>  <p>RPFT20-P2</p>	<p>P3 = 1 pc Playfield</p>  <p>RPFT20-P3</p>	<p>P4A = 2 pcs Left Leg</p>  <p>RPFT20-P4A</p>
<p>P4B = 2 pcs Right Leg</p>  <p>RPFT20-P4B</p>	<p>P5 = 2 pcs Leg Cross Tube</p>  <p><b>NOTE: Parts are packed inside of Leg.</b></p> <p>RPFT20-P5</p>	<p>P6 = 8 pcs Rod Handle</p>  <p>RPFT20-P6</p>	<p>P7 = 3 pcs Playfield Support Brace</p>  <p><b>NOTE: Parts are packed inside of Leg.</b></p> <p>RPFT20-P7</p>
<p>P9 = 2 pcs Wooden Ball Catcher</p>  <p>RPFT20-P9</p>	<p>P10 = 8 pcs Rod End Cap</p>  <p>RPFT20-P10</p>	<p>P11 = 2 sets Scorer</p>  <p>RPFT20-P11</p>	
<p>C1 = 2 pcs 5 Player Rod</p>  <p>RPFT20-C1</p>	<p>C2 = 4 pcs 3 Player Rod</p>  <p>RPFT20-C2</p>	<p>C3 = 2 pcs 2 Player Rod</p>  <p>RPFT20-C3</p>	<p>C4 = 16 pcs Rod Bumper</p>  <p>RPFT20-C4</p>
<p>C5 = 32 pcs Rod Washer</p>  <p>RPFT20-C5</p>	<p>C6 = 26 pcs 4mm x 25mm Phillips Round Head Bolt</p>  <p>RPFT20-C6</p>	<p>C7 = 26 pcs 4mm Nut</p>  <p>RPFT20-C7</p>	<p>C8 = 11 pcs Blue Shirt / White Short Player</p>  <p>RPFT20-C8</p>

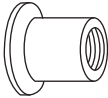
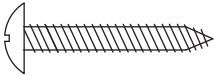
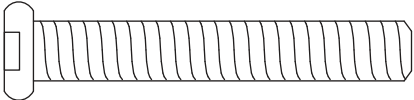
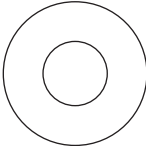
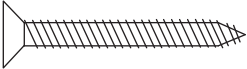
**NOTE: P5 AND P7 PARTS ARE PACKED INSIDE OF LEGS.**

**WARNING:**  
CHOKING HAZARD  
Small parts.  
Not for children under 3 yrs.

<p>C9 = 11 pcs Red Shirt / White Short Player</p>  <p>RPFT20-C9</p>	<p>C10 = 4 pcs One Player Rod Stop</p>  <p>RPFT20-C10</p>		
<p>H1 = 8 pcs 3.5mm x 25mm Phillips Round Head Screw</p>  <p>RPFT20-H1</p>	<p>H3 = 3 pcs Playfield Support Rod</p>  <p><b>NOTE: Parts are packed inside of Leg.</b></p> <p>RPFT20-H3</p>	<p>H4 = 6 pcs Allen Head Nut for Playfield Support Rod</p>  <p>RPFT20-H4</p>	<p>H5 = 8 pcs 3.5mm x 25mm Phillips Round Head Screw</p>  <p>RPFT20-H5</p>
<p>H6 = 24 pcs 7.5mm x 50mm Allen Head Bolt</p>  <p>RPFT20-H6</p>		<p>H7 = 24 pcs 8.5mm x 19mm Flat Washer</p>  <p>RPFT20-H7</p>	<p>H8 = 4 pcs 3.5mm x 32mm Phillips Flat Head Screw</p>  <p>RPFT20-H8</p>
<p>A1 = 2 pcs Soccer Ball</p>  <p>RPFT20-A1</p>	<p>A2 = 2 pcs 6mm Allen Wrench</p>  <p>RPFT20-A2</p>	<p>A3 = 1 pc 4mm Allen Wrench</p>  <p>RPFT20-A3</p>	

**NOTE: H3 PARTS ARE PACKED INSIDE OF LEGS.**



### PARTS REQUIRED:

- 3 pcs - H3 Playfield Support Rod
- 6 pcs - H4 Playfield Support Rod Nut
- 2 pcs - P1 Side Apron
- 1 pc - P3 Playfield
- 3 pcs - P7 Playfield Support Brace
- 2 pcs - A2 6mm Allen Wrench

### STEP 1:

Find a clean, level place to begin the assembly of your soccer table. We recommend building the table on the box top to protect the parts during assembly.

With the help of another adult, carefully assemble **P1** Side Aprons, **P3** Playfield and **P7** Playfield Support Braces using **H3** Support Rods, **H4** Support Rod Nuts with **A2** Allen Wrenches as shown in **FIGURE 1**.

**Do not tighten H4 Support Rod Nuts at this time.**

**NOTE: This assembly is upside down.**

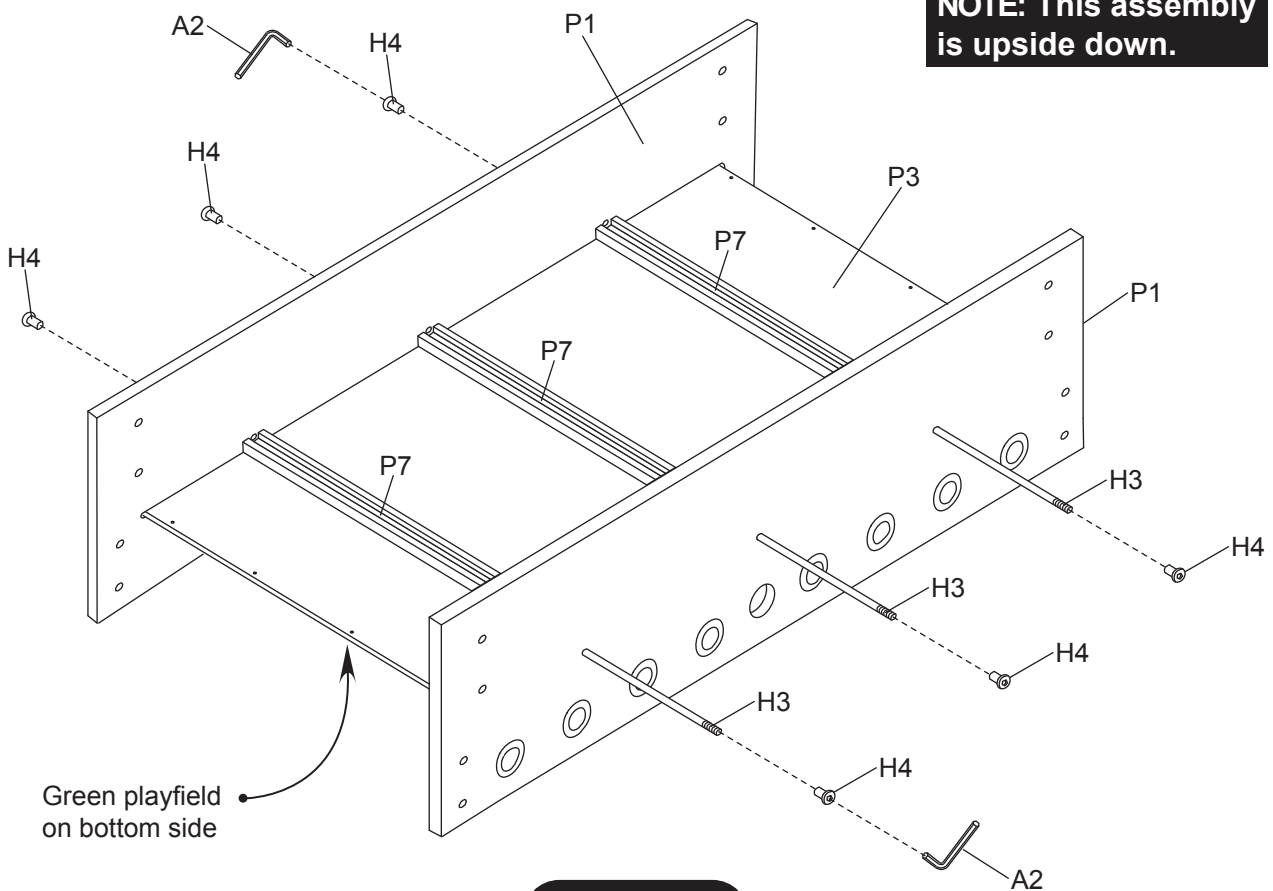

**FIGURE 1**

### PARTS REQUIRED:

8 pcs - H1 Phillips Round Head Screw	2 pcs - P2 End Apron
8 pcs - H6 Allen Head Bolt	2 pcs - A2 6mm Allen Wrench
8 pcs - H7 Flat Washer	1 pc - A3 4mm Allen Wrench

#### STEP 2:

Attach P2 End Aprons to previous assembly **STEP 1** using H6 Allen Head Bolts with H7 Flat Washers as shown in **FIGURE 2**. **Do not tighten H6 Allen Head Bolts on this time.**

Please make sure P3 Playfield is flush with both ends of P2 End Apron, tighten H6 Allen Head Bolts using A3 Allen Wrench on this time.

Secure P3 Playfield to P2 End Apron using pre-drilled holes with H1 Screws as shown in **FIGURE 2**.

**IMPORTANT NOTE: All screws must be screwed STRAIGHT down. Tighten, but do not strip out H1 Screws.**

Using A2 Allen Wrenches to tighten H4 Support Rod Nuts as shown in **FIGURE 2**.

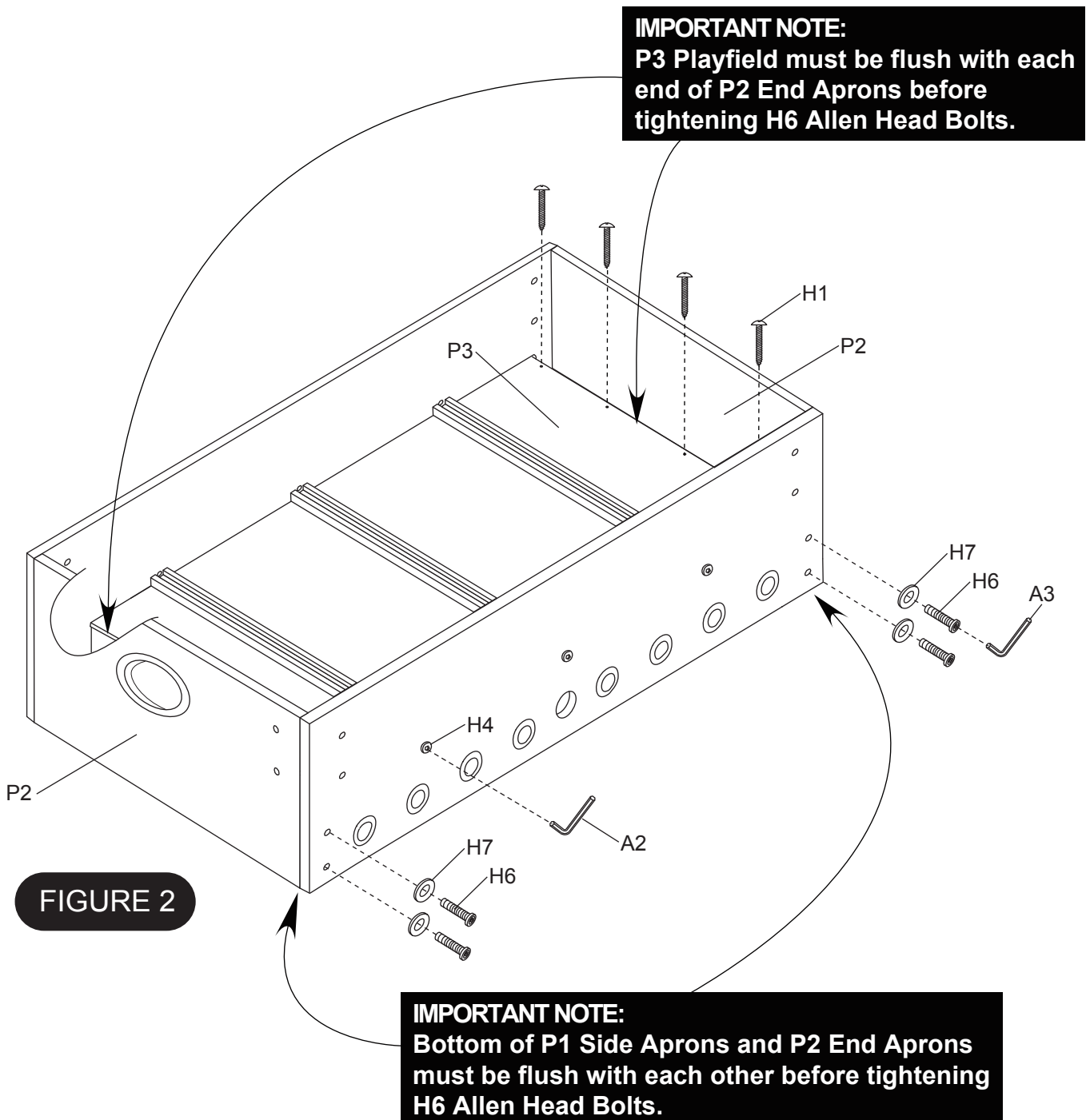

### PARTS REQUIRED:

8 pcs - H5 Phillips Flat Head Screw	2 pcs - P4A Left Leg
16 pcs - H6 Allen Head Bolt	2 pcs - P4B Right Leg
16 pcs - H7 Flat Washer	2 pcs - P5 Leg Cross Tube
2 pcs - P9 Wooden Ball Catcher	1 pc - A3 4mm Allen Wrench

### STEP 3:

Install P9 Wooden Ball Catchers using H5 Screws as shown in FIGURE 3.

Tighten, but do not strip out H5 Screws.

Install P4A Left Legs and P4B Right Legs with P5 Leg Cross Tubes using H6 Allen Head Bolts with H7 Flat Washers as shown in FIGURE 3. Use A3 Allen Wrench to tighten all H6 Bolts.

### IMPORTANT NOTE:

Install P5 Leg Cross Tubes before tightening H6 Leg Bolts.

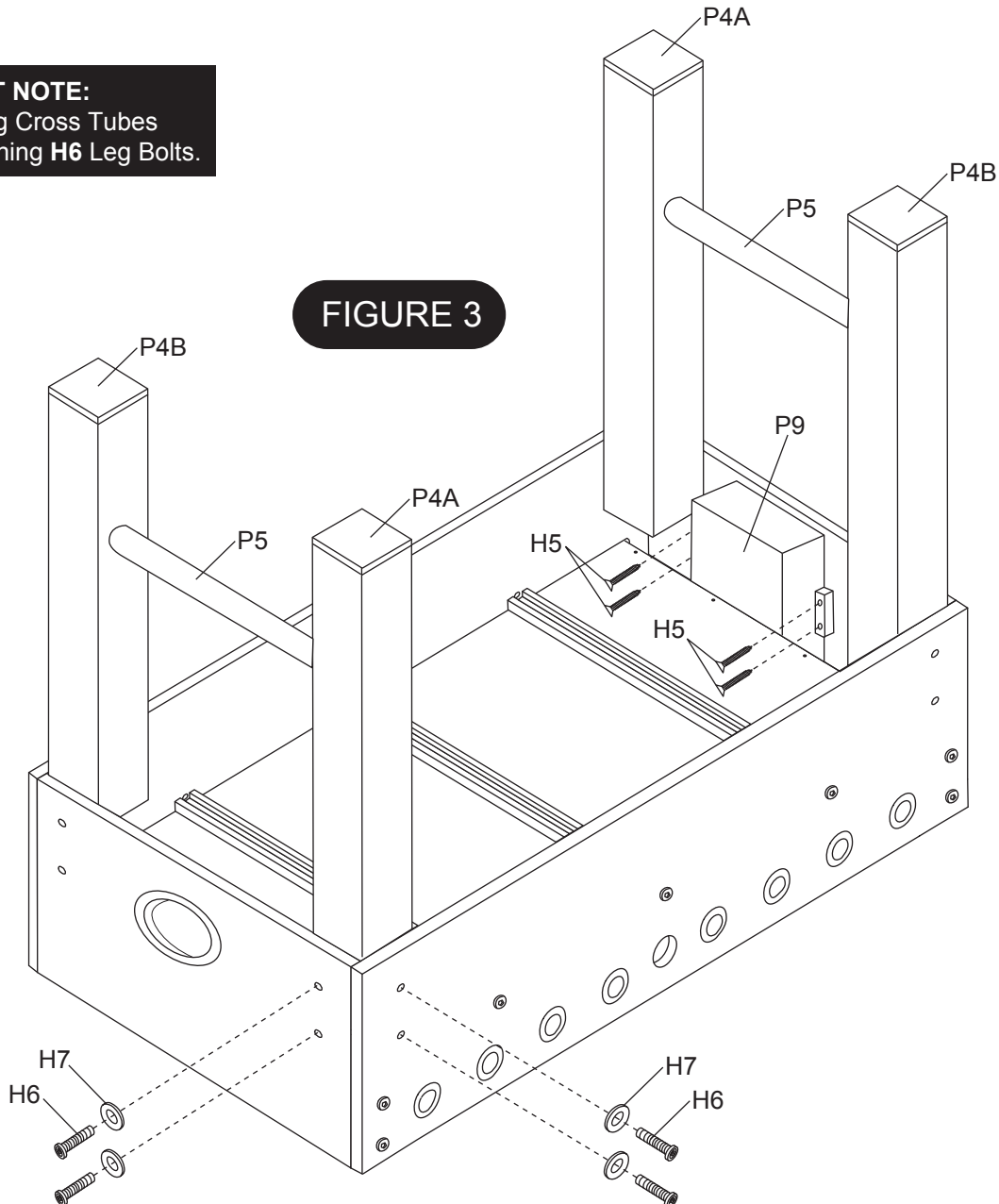

### WARNING:

THIS STEP REQUIRES TWO OR MORE ADULTS.  
VERY CAREFULLY TURN THE TABLE OVER AND  
SET IT ON ITS LEGS.

## PARTS REQUIRED:

1 pc - C1 5 Player Rod  
2 pcs - C2 3 Player Rod  
1 pc - C3 2 Player Rod  
8 pcs - C4 Rod Bumper

16 pcs - C5 Rod Washer  
13 pcs - C6 Phillips Round Head Bolt  
13 pcs - C7 Lock Nut

11 pcs - C8 Blue Shirt / White Short Player  
2 pcs - C10 One Player Stop Rod  
4 pcs - P6 Rod Handle  
4 pcs - P10 Rod End Cap

### STEP 4:

Slide C1 5 Player Rod, C2 3 Player Rods and C3 2 Player Rod through Rod Bushings of one P1 Side Apron as shown in FIGURE 4. **IMPORTANT NOTE:** Please note the location of the hole that is near one end of each rod. This is the handle end of the rod.

Place one C5 Rod Washer, C4 Rod Bumper and one C5 Rod Washer on each rod as shown in FIGURE 4.

Place C8 Blue Shirt / White Short Players (●) and C10 One Player Stop Rod (⊠) on rod as shown in FIGURE 4.

**IMPORTANT NOTE:** The goalie should be at your left and your team (player face) facing to the right. Looking ahead to FIGURE 8 - will help you with correct player and rod handle assembly onto rods.

Place one C5 Rod Washer, C4 Rod Bumper and one C5 Rod Washer on each rod as shown in FIGURE 4.

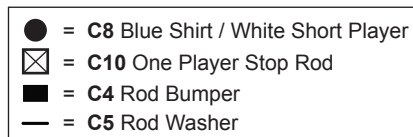

**Rod Bushing**  
Note: Rod Bushings are already attached onto each P1 Side Apron.

### OVERHEAD VIEW LOOKING DOWN ONTO TABLE

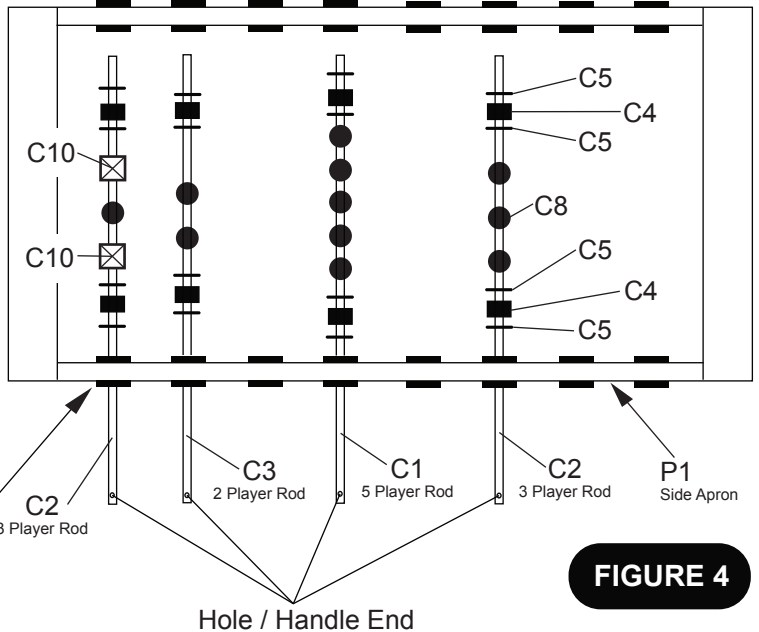

FIGURE 4

LEFT • RIGHT

### STEP 5:

Align C8 Blue Shirt / White Short Player and C10 One Player Stop Rod to each player hole and attach using C6 Bolts with C7 Lock Nut as shown in FIGURE 5 and DETAIL A.

Attach P10 Rod End Caps to the rod as shown in FIGURE 5.

Slide P6 Rod Handle onto each rod end with the small hole shown in FIGURE 5.

**IMPORTANT NOTE:** A small amount of liquid soap applied inside each P6 Rod Handle will allow them to slip onto rod easier.

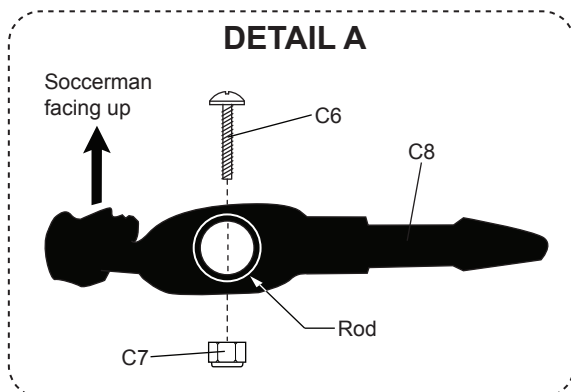

### OVERHEAD VIEW LOOKING DOWN ONTO TABLE

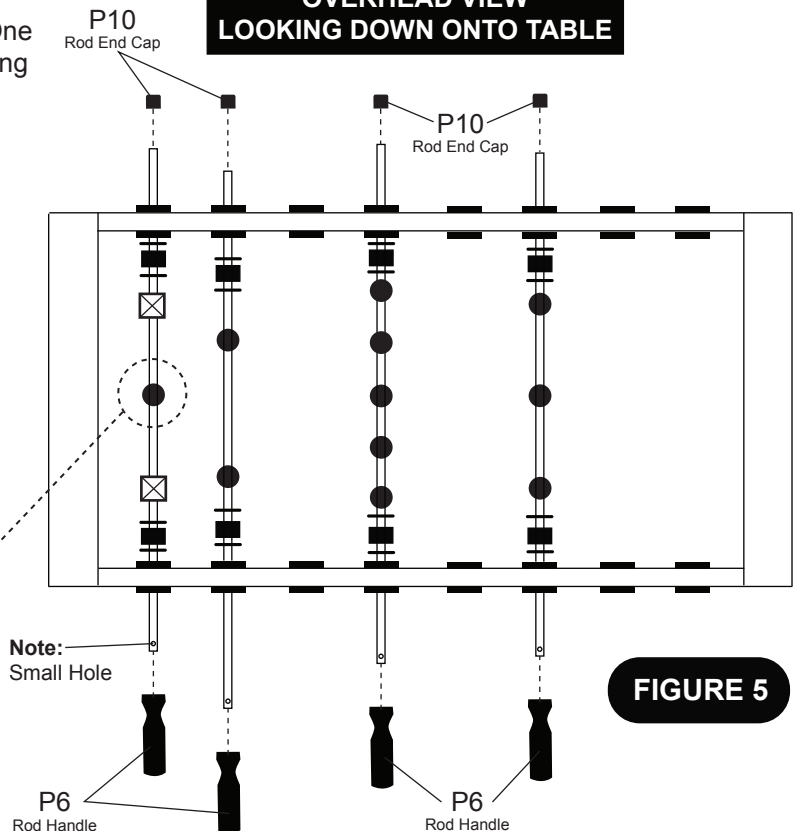

FIGURE 5



## PARTS REQUIRED:

1 pc - **C1** 5 Player Rod  
 2 pcs - **C2** 3 Player Rod  
 1 pc - **C3** 2 Player Rod  
 8 pcs - **C4** Rod Bumper

16 pcs - **C5** Rod Washer  
 13 pcs - **C6** Phillips Round  
 Head Bolt  
 13 pcs - **C7** Lock Nut

11 pcs - **C9** Red Shirt / White Short Player  
 2 pcs - **C10** One Player Stop Rod  
 4 pcs - **P6** Rod Handle  
 4 pcs - **P10** Rod End Cap

### STEP 6:

Slide **C1** 5 Player Rod, **C2** 3 Player Rods and **C3** 2 Player Rod through Rod Bushings of one **P1** Side Apron as shown in **FIGURE 6**.

**IMPORTANT NOTE:** Please note the location of the hole that is near one end of each rod. This is the handle end of the rod.

Place one **C5** Rod Washer, **C4** Rod Bumper and one **C5** Rod Washer on each rod as shown in **FIGURE 6**.

Place **C8** Red Shirt / White Short Players (○) and **C10** One Player Stop Rod (⊠) on rod as shown in **FIGURE 6**.

**IMPORTANT NOTE:** The goalie should be at your left and your team (player face) facing to the right. Looking ahead to **FIGURE 8** - will help you with correct player and rod handle assembly onto rods.

Place one **C5** Rod Washer, **C4** Rod Bumper and one **C5** Rod Washer on each rod as shown in **FIGURE 6**.

- = **C9** Red Shirt / White Short Player
- ⊠ = **C10** One Player Stop Rod
- = **C4** Rod Bumper
- = **C5** Rod Washer

### OVERHEAD VIEW LOOKING DOWN ONTO TABLE

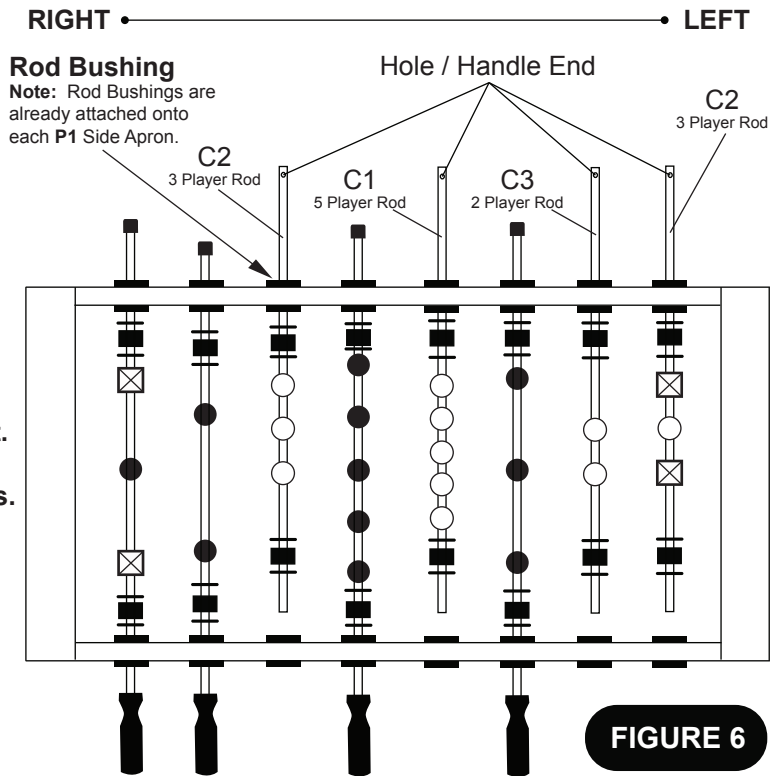

### STEP 7:

Align **C9** Red Shirt / White Short Player and **C10** One Player Stop Rod to each player hole and attach using **C6** Bolts with **C7** Lock Nut as shown in **FIGURE 7** and **DETAIL B**.

Attach **P10** Rod End Caps to the rod as shown in **FIGURE 7**.

Slide **P6** Rod Handle onto each rod end with the small hole shown in **FIGURE 7**.

**IMPORTANT NOTE:** A small amount of liquid soap applied inside each **P6** Rod Handle will allow them to slip onto rod easier.

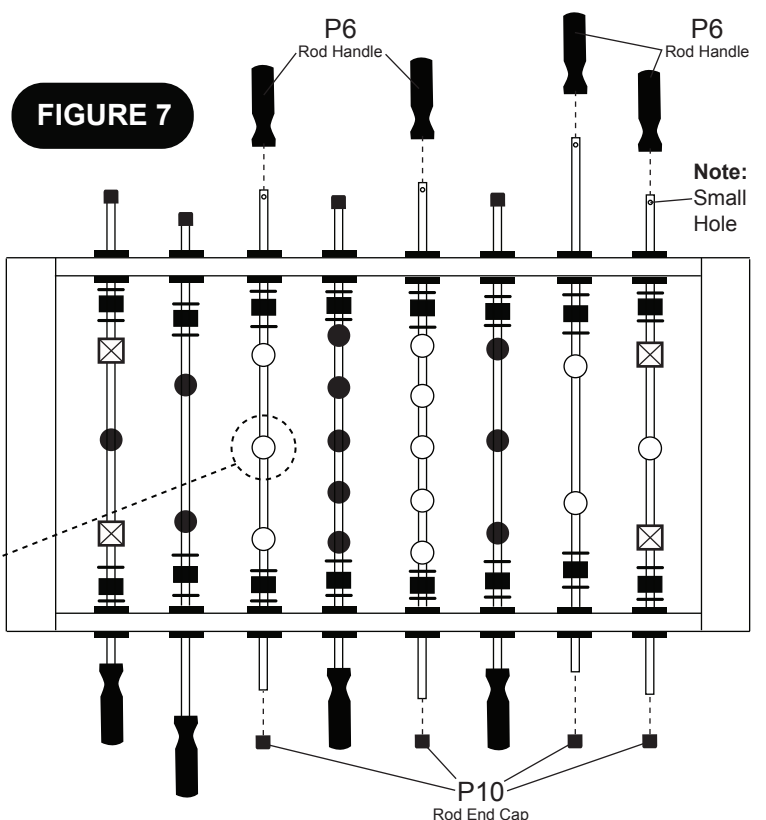

### DETAIL B

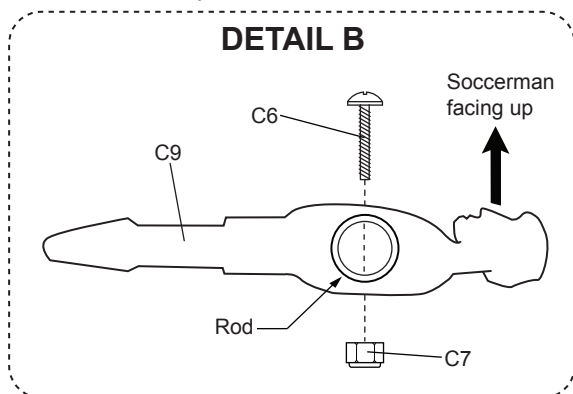

**PARTS REQUIRED:**

- 4 pcs - H8 Phillips Flat Head Screw
- 2 pcs - P11 Scorer

**STEP 8:**

Attach P11 Scorers using pre-drilled holes with H8 Phillips Flat Head Screws as shown in **FIGURE 8**. Tighten, but do not strip out H8 Screws.

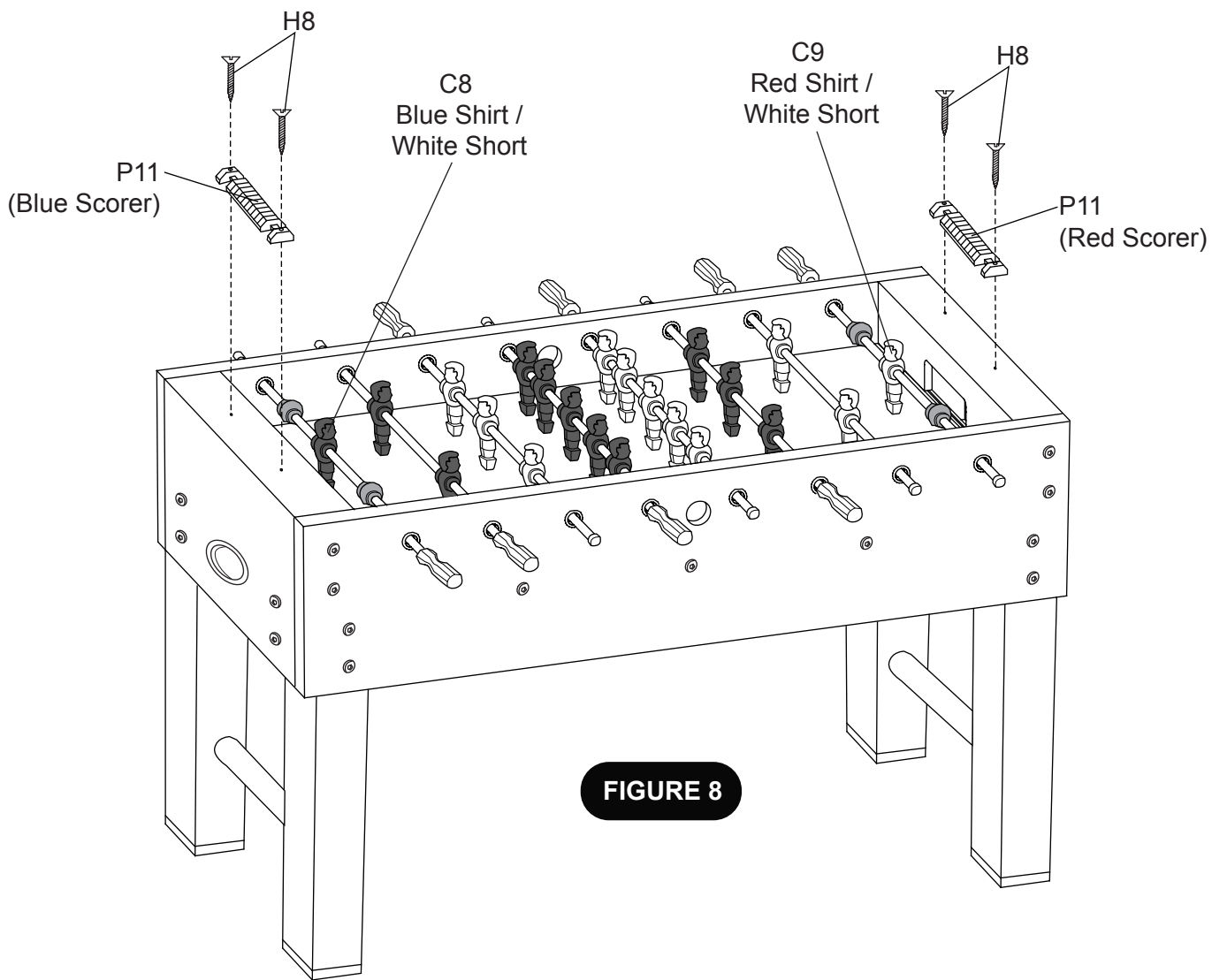

**Congratulations! You have now assembled your soccer table. Please note the Care and Use instructions below to insure many years of trouble free use of your soccer table.**

### **CARE AND USE OF YOUR SOCCER TABLE**

1. Apply spray furniture polish to a clean cloth and wipe down the rods to make them slide easier in the rod bushings.
2. Use spray furniture polish to clean all exterior surfaces of your soccer table.
3. This product is intended for **INDOOR** use only.
4. **DO NOT** sit, climb or lean on the table.
5. **DO NOT** drag the table when moving it. This will damage the legs.
6. **DO NOT** set drinks on the table.

### **PRODUCT PARTS LIST FOR MODEL # FT200**

Key #	Part #	Description	Qty.
P1	RPFT20-P1	Side Apron	2
P2	RPFT20-P2	End Apron	2
P3	RPFT20-P3	Playfield	1
P4A	RPFT20-P4A	Left Leg	2
P4B	RPFT20-P4B	Right Leg	2
P5	RPFT20-P5	Leg Cross Tube	2
P6	RPFT20-P6	Rod Handle	8
P7	RPFT20-P7	Playfield Support Brace	3
P9	RPFT20-P9	Wooden Ball Catcher	2
P10	RPFT20-P10	Rod End Cap	8
P11	RPFT20-P11	Scorer (Set)	2
C1	RPFT20-C1	5 Player Rod	2
C2	RPFT20-C2	3 Player Rod	4
C3	RPFT20-C3	2 Player Rod	2
C4	RPFT20-C4	Rod Bumper	16
C5	RPFT20-C5	Rod Washer	32
C6	RPFT20-C6	4mm x 25mm Phillips Round Head Bolt	26
C7	RPFT20-C7	4mm Nut	26
C8	RPFT20-C8	Blue Shirt / White Short Player	11
C9	RPFT20-C9	Red Shirt / White Short Player	11
C10	RPFT20-C10	One Player Rod Stopper	4
H1	RPFT20-H1	3.5mm x 25mm Phillips Round Head Screw	8
H3	RPFT20-H3	Playfield Support Rod	3
H4	RPFT20-H4	Allen Head Nut for Playfield Support Rod	6
H5	RPFT20-H5	3.5mm x 25mm Phillips Round Head Screw	8
H6	RPFT20-H6	7.5mm x 50mm Allen Head Bolt	24
H7	RPFT20-H7	8.5mm x 19mm Flat Washer	24
H8	RPFT20-H8	3.5mm x 32mm Phillips Flat Head Screw	4
A1	RPFT20-A1	Soccer Ball	2
A2	RPFT20-A2	6mm Allen Wrench	2
A3	RPFT20-A3	4mm Allen Wrench	1

## 90 DAY LIMITED WARRANTY

This consumer warranty extends to the original consumer purchase of any ESCALADESPORTS Product (hereinafter referred as the "Product").

**WARRANTY DURATION:** This Product is warranted to the original consumer purchase of a period of 90 days from the original purchase.

**WARRANTY COVERAGE:** ESCALADE SPORTS warrants to the original Consumer Purchaser that any Product of its manufacture is free from defects in material and workmanship when used for the intended purpose under normal use and conditions. THIS WARRANTY IS VOID IF THE PRODUCT HAS BEEN DAMAGED BY ACCIDENT, UNREASONABLE USE, NEGLIGENCE, IMPROPER SERVICE, FAILURE TO FOLLOW INSTRUCTIONS PROVIDED WITH THE PRODUCT OR OTHER CAUSES NOT ARISING OUT OF DEFECTS IN MATERIAL AND WORKMANSHIP.

**WARRANTY PERFORMANCE:** During the above 90 day warranty period, ESCALADESPORTS shall repair or replace with a comparable model, and Product, or component thereof, which may prove defective under normal use and proper care, and which our examination shall disclose to our satisfaction to be thus defective, please contact our Warranty Dept.

1-888-996-2729 / Warranty Dept.

Or Write us at:

Escalade® Sports, Inc. - P.O. Box 889, Evansville, IN 47706

Attn: Warranty Dept.

Or E-mail us at:

gameroom@escaladesports.com

Other than shipping requirements no charge will be made for such repair or replacement of in-warranty Products. ESCALADE SPORTS strongly recommends that the Product is insured for value prior to mailing.

**WARRANTY DISCLAIMERS:** ANY IMPLIED WARRANTIES ARISING OUT OF THIS SALE, INCLUDING BUT NOT LIMITED TO THE IMPLIED WARRANTIES OF MERCHANTABILITY AND FITNESS FOR A PARTICULAR PURPOSE, ARE LIMITED IN DURATION TO THE ABOVE 90 DAY PERIOD. ESCALADE SPORTS SHALL NOT BE LIABLE FOR LOSS OF USE OF THE PRODUCT OR OTHER CONSEQUENTIAL OR INCIDENTAL COSTS, EXPENSES OR DAMAGES INCURRED BY THE CONSUMER OF ANY OTHER USE.

Some states do not allow the exclusion or limitation of implied warranties or consequential or incidental damages, so the above limitations or exclusions may not apply to you.

**LEGAL REMEDIES:** This warranty gives you specific legal rights and you may also have other rights which may vary from state to state.