

Elite
BY MAXI-MATIC®

P L A T I N U M

10Qt. Electric Pressure Cooker



Model EPC-1013

INSTRUCTION MANUAL

Before operating your new appliance,
please read all instructions carefully and keep for future reference

IMPORTANT SAFEGUARDS

When using pressure cookers, basic safety precautions should always be followed:

1. Read all instructions before operation.
2. Do not operate while unattended.
3. Do not touch hot surfaces. Use handles or knobs.
4. Close supervision is necessary when the pressure cooker is used near children.
5. DO NOT allow children to operate under any circumstance.
6. Do not place the pressure cooker in a heated oven.
7. Extreme caution must be used when moving a pressure cooker containing hot liquids.
8. Do not use pressure cooker for other than intended use.
9. Never immerse product in water or other liquids.
10. This appliance cooks under pressure. Improper use may result in scalding injury.
11. Make certain unit is properly closed before operating. See Operating Instructions.
12. Do not fill the unit over 2/3 full. When cooking foods that expand during cooking such as rice or dried vegetables, do not fill the unit over 1/2 full. Over filling may cause a risk of clogging the vent pipe and developing excess pressure. Failure to follow this procedure can result in injury to person(s) and/or damage to the unit.
13. Be aware that certain foods, such as applesauce, cranberries, pearl barley, oatmeal or other cereals, split peas, noodles, macaroni, rhubarb, or spaghetti can foam, froth, and sputter, and clog the pressure release device (steam vent). These foods should not be cooked in a pressure cooker.
14. When the normal operating pressure is reached, turn the heat down so all the liquid which creates the steam does not evaporate.
15. Always check the pressure release devices for clogging before use.
16. Do not open the pressure cooker until the unit has cooled and all internal pressure has been released. If the handles are difficult to push apart, this indicates that the cooker is still pressurized – do not force it open. Any pressure in the cooker can be hazardous. See Operating Instructions.
17. Do not use this pressure cooker for pressure frying with oil.
18. DO NOT place the product near flammable materials or use in a humid environment.
19. DO NOT damage the Seal Belt and DO NOT replace it with anything other than the replacement belt designated for this unit.
20. DO NOT tamper with the Steel Ring in the Lid (2) with any tools or external forces. If the Steel Ring is damaged, please stop using immediately and replace the Lid.
21. Clean the Filter (17) regularly to keep the cooker clean.
22. NEVER use additional weight on the Pressure Limiting Valve (3) or replace the Pressure Limiting Valve (3) with anything not intended for use with this unit.

IMPORTANT SAFEGUARDS

23. The surface of contact between the Inner Pot (6) and the Electronic Heater (14) should always be clean. DO NOT use the Inner Pot with other heating sources. DO NOT replace the Inner Pot with a container other than what is recommended by the manufacturer.
24. The Inner Pot consists of a non-stick layer surface. To avoid scratching the non-stick surface, please use wooden or plastic utensils.
25. Food should not be kept warm for more than 4 hours in order to maintain the freshness of the food. The pressure cooker should not be used for more than 6 hours continuously. Serious Injury and/or damage may occur if any safeguards are ignored.
26. If steam releases around the Lid (2) during the cooking process, please unplug from the power supply immediately, let cool, remove contents and return the product to the manufacturer for exchange or repair. The Pressure Discharging Device has activated. This is a safeguard to alert the user that the Pressure Limiting Device is malfunctioning
27. If there is any malfunction of the cooker during the cooking process, please stop using the device and return to the manufacturer for repair or exchange.
28. Do not let cord hang over edge of table or counter, or touch hot surfaces.
29. Unplug from outlet when not in use and before cleaning. Allow to cool before putting on or taking off parts.
31. Do not operate this appliance with a damaged cord or plug or after it malfunctions or has been damaged in any manner. Bring it to a qualified technician for examination, repair or electrical or mechanical adjustment. DO NOT disassemble the product, or replace parts with parts not intended for this unit.
32. Always attach plug to appliance first, then plug cord into the wall outlet. To disconnect, turn any control to off, then remove plug from wall outlet.
33. Do not use outdoors.
34. Do not place on or near a hot gas or electric burner, or in a heated oven.
35. Any other servicing should be performed by an authorized service representative.
36. The use of accessory attachments not recommended by the appliance manufacturer may cause injuries.

**SAVE THESE INSTRUCTIONS
FOR HOUSEHOLD USE ONLY**

SAFETY WARNING: There is a potential risk of fire, electric shock or injury to persons if the product is not used as instructed. Protection against electric shock is assured only if the main power cord is connected to a properly grounded 120V | 60Hz power receptacle.

- This product is to be used in an indoor environment only and is not intended for commercial use. Dry locations only.
- All parts and accessories for this appliance must be used properly according to the instructions. All parts and accessories must be the original provided from manufacturer. All other parts or accessories that is not intended for use with this appliance is strictly prohibited.
- The use of an extension cord, power adapter or other electric devices is highly not recommended.

LED ERROR INDICATOR

Indicator Code	Problems/Causes
E1	Open Circuit of the Sensor
E2	Short Circuit of the Sensor
E3	Overheating
E4	Signal Switch Malfunction

ABOUT YOUR PRESSURE COOKER

This digitally controlled and automatic pressure cooker uses advanced technology so you and your family can enjoy the benefits of better, faster and healthier cooking. Your Elite Platinum Pressure Cooker seals in steam to cook hotter and faster while maintaining important nutrients for healthier meals. Cooking fast and with less water saves vital natural resources and energy! The unit features easy touch-button settings, a countdown timer, and a very large cooking pot big enough for family gatherings! It's the easiest pressure cooker to use on the market. It may seem like a complicated unit but rest assured, this pressure cooker is simple to use, makes meals quick and easy, and overall it saves you money! Please accept our thanks for purchasing a Elite Platinum Pressure Cooker and Enjoy!

PRESSURE COOKER WITH MULTIPLE FUNCTIONS:

- Multiple functions for cooking, stewing, braising, simmering, and roasting.
- Cooking will be done automatically by selecting the different menu choices on the unit. When the food has completed its cooking cycle, there will be a (3) beep indicator, followed by the unit automatically switching to the Keep Warm mode.
- A delay timer allows the user to delay the start of cooking by up to 24-hours. When the timer is set, the count-down will start. At the end of the countdown, the cooker will start to heat up.
- The pressure cooker also has its own memory. During interruptions such as a power failure, the unit will automatically renew the cooking cycle where the unit left off when the power resumes.

RAPID COOKING; TIME & POWER SAVING:

- By using high pressure (high temperature), food will be cooked much more rapidly. This will reduce the cooking time and consumption of power. For example: when cooking rice, this pressure cooker will save up to 20% of the electricity and up to 15% of the time when compared to a conventional rice cooker. When cooking stew, soups or braising meats, this cooker will save more than 40% of time and more than 45% of power as compared to a conventional slow cooker. Cooking can also be done at high altitudes.

PRESERVE NUTRIENTS & PROMOTES HEALTHY EATING:

- Airtight cooking methods preserve nutrients and original flavor of food.

SHORT CORD PURPOSE

NOTE: A short power cord is provided to reduce the risk of personal injury resulting from becoming entangled in or tripping over a longer cord.

Longer power-supply cords or extension cords are available and may be used if care is exercised in their use.

If an extension cord is used: (1) the marked electrical rating of the extension cord should be at least as great as the electrical rating of the product; (2) the extension cord should be arranged so that it will not drape over the countertop or tabletop where it can unintentionally be pulled on or tripped over by children or pets.

POLARIZED PLUG

If this appliance is equipped with a *polarized plug* (one blade is wider than the other), please follow the below instructions:

To reduce the risk of electrical shock, this plug is intended to fit into a polarized outlet only one way. If you are unable to fit the plug into the electrical outlet, try reversing the plug. If the plug

still does not fit, contact a qualified electrician. Never use the plug with an extension cord unless the plug can be fully inserted into the extension cord. Do not alter the plug of the product or any extension cord being used with this product. Do not attempt to defeat the safety purpose of the polarized plug.

STOP!

Under NO circumstances should this Pressure Cooker or any of its parts or components be placed ON or NEAR a Stovetop, Range, or Open Flame.

Doing so will cause serious damage to the Pressure Cooker and/or injury to person.

This is NOT a Stovetop Pressure Cooker.

PARTS IDENTIFICATION

Floating Valve

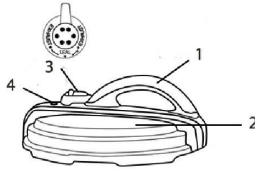
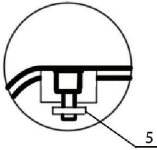

Dismantling of condensation cup



Control Panel

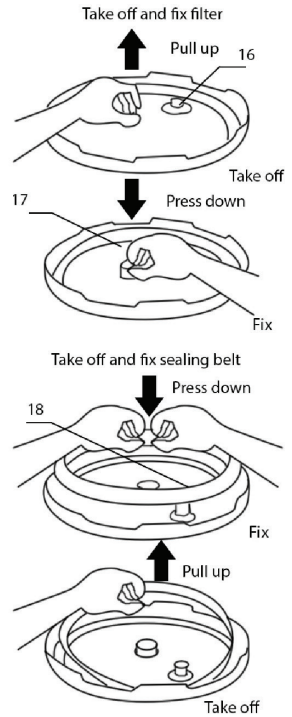
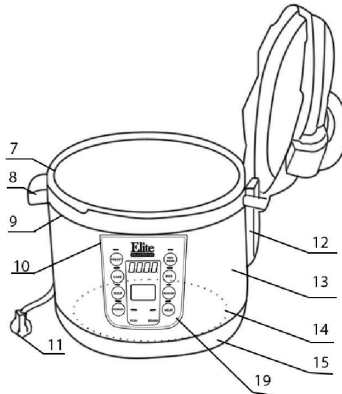
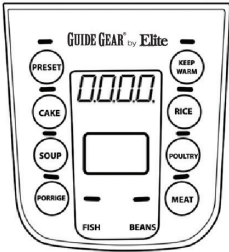

Accessories



Measuring cup

Spoon

- | | | |
|--------------------------------|-----------------------|-------------------------------|
| 1. Handle | 9. Upper Ring | 15. Bottom Ring |
| 2. Lid | 10. Control Panel | 16. Seal Ring for Float Valve |
| 3. Pressure Limiting Valve | 11. Power Cable | 17. Filter |
| 4. Float Valve (external view) | 12. Condensation Cup | 18. Rubber Seal Ring |
| 5. Float Valve (internal view) | 13. Main Body | 19. Sensor |
| 6. Inner Pot | 14. Electronic Heater | |
| 7. Outer Pot | | |
| 8. Handle | | |

The Inner Pot (6) consists of a non-stick surface. To avoid scratching the non-stick surface, please use wooden or plastic utensils.

BEFORE FIRST USE

Working Pressure	PSI	Maximum Pressure	Keep Warm Temperature	Delay Timer
0~70kPa	12 PSI	90kPa	140°F ~ 175 °F	0.5~24 HR

1. Remove packaging materials such as cardboard, plastics or Styrofoam and discard appropriately.
2. Clean all the parts by wiping with a soft damp cloth or sponge and dry thoroughly.

LID ASSEMBLY:

1. **How to open the lid:** When the lid (2) of the cooker is at the closed position, hold the Handle (1) and turn it clockwise until the lid loosens (Figure 1). Lift up and remove the lid (Figure 2)

Note: For new units, the seal of the lid may be slightly stronger than normal and may be slightly difficult to unlock. Once the lid has been opened and closed several times, it will loosen up.

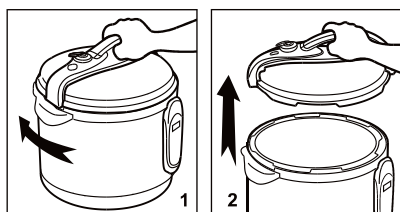

2. **How to close the lid:** When the Lid (2) of the cooker is in vertical position, hold the Handle (1) and close it downwards at the Opened Lid position (Figure 3). Turn counter-clockwise until you reach the Closed Lid position. (Figure 4).

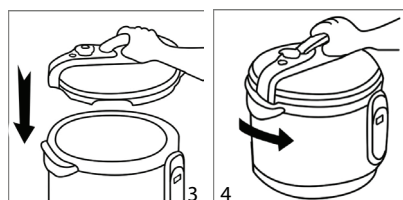

3. **How to Clean the Filter:** If you wish to clean the filter, you may remove it by pulling vertically. To re-attach, simply line up the filter and press down to secure the filter (Figure 5).

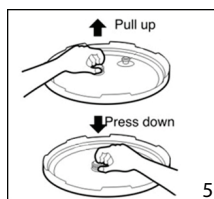

PREPARING YOUR PRESSURE COOKER

1. To open the lid, hold the Handle (1) and turn it in a clockwise direction until you reach the Opened Lid position (Figure 6). Then pull upwards to vertical position (Figure 7). Once the lid is removed, place the lid onto a flat surface such as a counter or table.

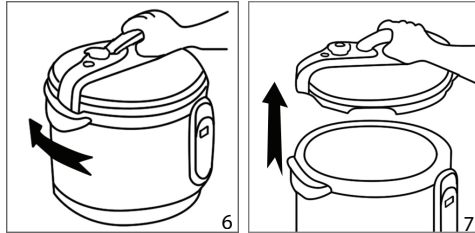

2. Remove the inner pot (6) and place desired food and liquids into the pot. The amount of water and food should not exceed $\frac{4}{5}$ of the height of the inner Pot (Figure 8.) For food that will expand in water, the level should not exceed $\frac{3}{5}$ of the Inner Pot (Figure 8). The minimum level for cooking would be $\frac{1}{5}$ of the Inner Pot (Figure 8).

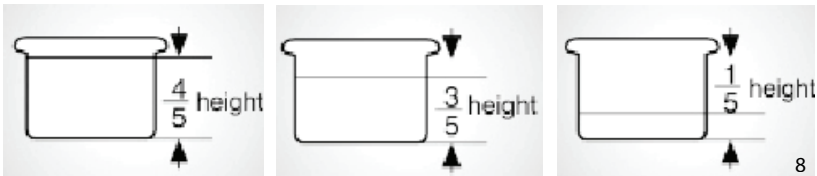

*Cooking Rice

- When cooking rice, the maximum amount of rice allowed for this 10 quart pressure cooker is 20 cups of uncooked rice using the measuring cup provided with this pressure cooker.
- Normally one cup of rice requires one cup of water. This may vary according to taste.

3. Be certain the inner receptacle, where the Electronic Heater is located, is clean before inserting the inner pot. Place the inner pot into the pressure cooker and adjust the pot left and right to ensure optimal contact between the Inner Pot and the Electronic Heater (Figure 9).

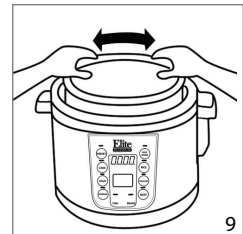

4. Closing the lid:

- a) Make sure the Rubber Seal Ring (18) is fitted properly onto the inner part of the lid (2).
- b) Observe the Rubber Seal Ring (18) inside the Lid (2) and ensure that it is evenly fitted into the track (Figure 10). **(Caution: If the rubber seal ring is damaged, do not use the pressure cooker. Contact Customer Service to repair or replace.)**
- c) Close the lid (2).
- d) Hold the Handle (1) and turn it to the "Closed" position or Counter -clockwise. (A clamping sound can be heard) (Figures 11 & 12).

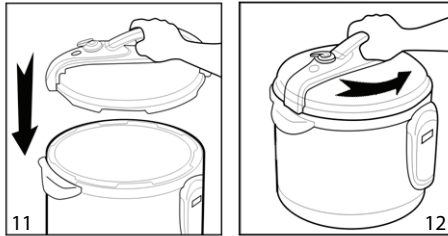
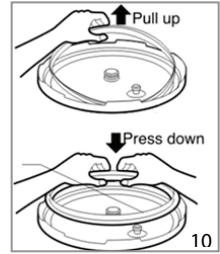

Note: To ensure you are properly closing the lid, please make sure the pressure limiting valve is on your left side when you are facing the front of the pressure cooker (when facing the control panel).

5. Adjust the Pressure Limiting Valve (3) to the "Air Tight" position , and ensure that the Float Valve (5) sinks.
6. When adjusting the Pressure Limiting Valve (3) to either the "Airtight" or the "Exhaust" positions, line up the marking on the Pressure Limiting Valve (3) with the arrow on the Handle (2) as shown in Figures 13 and 14.

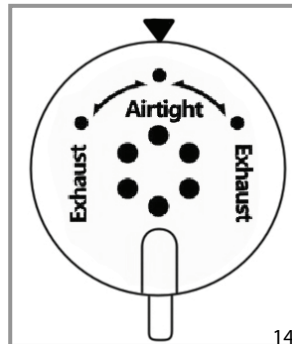
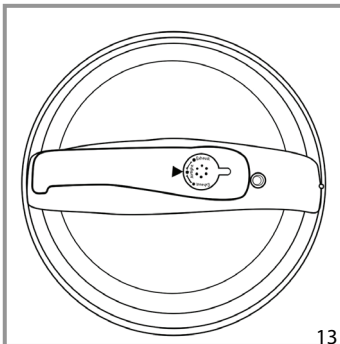

NOTES & TIPS #1:

- Please note that the Pressure Limiting Valve (3) will be loose when you are not using the unit for cooking. It will rock slightly and will turn 360° manually. Once the pressure cooker is in operation and the pressure has built up to its capacity, the Pressure Limiting Valve (3) will tighten, only allowing itself to be turned to the Left or Right to “Exhaust”. Once all the pressure has released, it will become loose again.

NOTES & TIPS #2:

- During the Pressure Building process, you may notice steam or pressure escaping from the Pressure Limiting Valve (3). Carefully adjust the valve by moving it gently or turning it side to side gently using tongs or similar utensil until it seals properly.
- If any steam is escaping around the lid, it means that the Rubber Seal Ring (18) may not have completed a tight seal when the lid was locked. Cancel the cooking process, release pressure manually or naturally, remove the lid and check the Rubber Seal Ring (18). Reposition the lid and ensure that it is secure. Start the cooking process again.
- Please note that steam escaping from the Valve or around the lid is normal for the first 5 minutes or so of the cooking process. If it continues beyond 10 minutes, please press the **Keep Warm/Cancel** button and follow the instructions to release all the pressure before removing the lid to check the Valve or the Rubber Seal Ring.

HOW TO USE YOUR PRESSURE COOKER

HOW TO USE THE MENU BUTTONS:

There are eight **Menu Buttons** programmed for your pressure cooker. They are **Rice, Soup & Stew, Meat & Chicken, Potatoes & Yams, Beans, Pork, Fish & Vegetables, and Desserts**. The default times are preset for quick and easy cooking for small portions of food. (When cooking food that is more than 3lbs. or more than 6-cups, please use the Timed Cooking function.) Each of the default times is programmed to detect the weight of food being cooked and how much liquid is inside the pot during the cooking cycle. The unit will automatically build up the pressure, cook the food and go to Keep Warm when cooking is complete.

FUNCTION	DEFAULT COOKING TIME	COOKING TIME RANGE
RICE	12 MIN	5-25 MIN
SOUP & STEW	25 MIN	5-60 MIN
MEAT & CHICKEN	12 MIN	5-60 MIN
POTATOES & YAMS	13 MIN	5-60 MIN
BEANS	40 MIN	5-90 MIN
PORK	15 MIN	5-70 MIN
FISH & VEGETABLES	5 MIN	3-15 MIN
DESSERTS	18 MIN	5-33 MIN

- 1) Prepare desired food and place into cooking pot.
- 2) Secure the Lid (2) onto the unit, turn it Counter-clockwise to lock it properly in place.
- 3) Make sure the Pressure Limiting Valve (3) is set to the "Airtight" position.
- 4) Plug the power cord into a 120V power outlet.
- 5) The LED screen will display **00 00**.
- 6) Choose the desired **Menu Button**. Press the **Menu Button** once, the indicator light will illuminate and the default cooking time (see chart referenced above) will be displayed. For example, if **Rice** function is chosen, the default cooking time is 12 minutes.
The LED Screen will display **P12**. The LED Screen and the **Rice** Indicator will blink five times and then illuminate solid once it begins operation. While the unit is building up pressure the display will show **00 12**.
- 7) The pressure cooker will begin to operate based on a cooking time of 12 minutes. **There is no need to press any other button**. When proper pressure is achieved, the display will show **P:12** and the cooking time will begin to countdown.
 - **When the unit has pressurized, it will begin to pressure-cook the food. You may hear quiet hissing or sizzling sounds coming from inside of the unit during this time.
 - **See Notes & Tips #2 if there is steam escaping from the Lid (2) or the Pressure Limiting Valve (3).

NOTES & TIPS #3:

When pressing a **Menu Button**, the LED screen will not immediately change until the pressure has built up to capacity. This may take approximately 5-10 minutes depending on the quantity of food you are cooking.

At any point during the selection process or the cooking process, you can press the **CANCEL button to cancel your selection or to cancel the cooking process.

NOTES & TIPS #4:

- When cooking soups or stews with other hearty ingredients such as potatoes or meat, as much as 5 or 6 cups of liquid must be used to prevent ingredients from over-cooking or burning.

- 8) When cooking has completed, the pressure cooker will beep 3-times and automatically go to Keep Warm. The display will show **bb** during Keep Warm.
- 9) The Keep Warm indicator light will illuminate. This means the Pressure Cooker is naturally releasing the pressure. Please see Tip#5.
- 10) If you wish to **Quick Release** the pressure, move the Pressure Limiting Valve (3) to "Exhaust" position to release the pressure until the Float Valve (5) sinks. (Figures 15 & 16).

- **CAUTION: Use an oven mitt or long utensil.** Keep hands and face away from Pressure Limiting Valve (3) while in the Exhaust position. Failure to comply may cause serious injury.

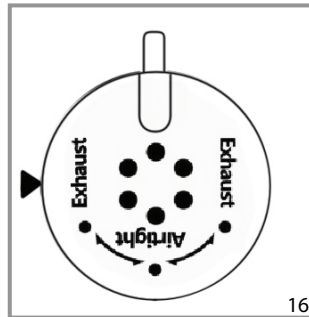
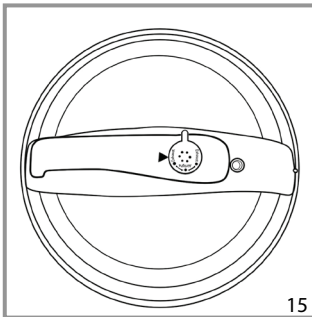

- 11) Always make certain the pressure is released completely before unlocking the lid and opening it.
- 12) Press Cancel to end operation and remove food to serve immediately or leave food inside the pressure cooker to keep warm. (It is not recommended to keep food warm for over 4-hours).

At any point during the selection process or the cooking process, you can press the **CANCEL button to cancel your selection or to cancel the

NOTES & TIPS #5:

- a. **NATURAL RELEASE** is recommended when cooking foods that will not have the tendency to overcook such as Potatoes, Beans, Soups & Stews. During the Natural Release time period, the pressure cooker may still be heated and cooking the food slightly. In Natural Release, you do not move the Pressure Limiting Valve (3) to EXHAUST immediately after cooking. Approximately 10-20 minutes after cooking is completed, you can check the Valve (3) by gently tapping it right or left. If it is loose and turns easily and no steam is released from the Valve (3), then all the pressure has now been released.
- b. **QUICK RELEASE** is recommended when cooking foods that you wish to be Medium or Medium-Rare such as Beef Roasts or Lamb. This will release the pressure quickly and prevent the food from over-cooking.
- **CAUTION: Use an oven mitt or long utensil.** Keep hands and face away from Pressure Limiting Valve (3) while in the Exhaust position. Failure to comply may cause serious injury.

HOW TO USE THE “PRESSURE COOK TIME” BUTTON:

Setting your own cook time is ideal for cooking meat or poultry that weighs more than 3-pounds. It is also suggested for slow-cooking certain recipes that require cooking for more than 30-minutes. The programmed cook time can be set up to 90-minutes.

- 1) Prepare desired food and place into cooking pot.
- 2) Secure the Lid (2) onto the unit, turn it Counter-clockwise to lock it in place properly.
- 3) Make sure the Pressure Limiting Valve (3) is set to the “Airtight” position.
- 4) Plug the power cord into a 120V power outlet.
- 5) The LED screen will display **00 00**.

Choose the desired **Menu Button**. Press the **Menu Button** once, the indicator light will illuminate and the default cooking time (see chart referenced under Operating Instructions-How to Use the Menu Buttons) will display. For example, if **Rice** function is chosen, the default cooking time is 12 minutes. The LED Screen will display **P12**. The LED Screen and the **Rice** Indicator will begin to blink.

- 6) The cooking time range for the **Rice** function is 5-25 minutes. This means the maximum cook time under **Rice** is 25 minutes and the minimum cook time is 5 minutes. Ex. To cook under the **Rice** function for 5 minutes, press the **Pressure Cook Time** button to increase the cooking time. Each incremental press of the button increases the cooking time by 1 minute. Hold the button down for rapid increase of cooking time.
 - 7) Press the **Pressure Cook Time** button past the 25 minute mark to start over at 5 minutes.
The screen will display **P:05** and the LED Screen and the **Rice** Indicator will blink five times and then illuminate solid when it begins operation. While the unit is building up pressure the display will show **00 05**.
 - 8) The pressure cooker will begin to operate based on a cooking time of 5 minutes. **There is no need to press any other button.** When proper pressure is achieved, the display will show **P:05** and the cooking time will begin to countdown.
****When the unit has pressurized, it will begin to pressure-cook the food. You may hear quiet hissing or sizzling sounds coming from inside of the unit during this time.**
****See Notes & Tips #2 if there is steam escaping from the Lid (2) or the Pressure Limiting Valve (3).**
 - 9) When cooking has completed, the pressure cooker will beep 3-times and automatically go to Keep Warm. The display will show **bb** during Keep Warm.
 - 10) The Keep Warm indicator light will illuminate. This means the Pressure Cooker is naturally releasing the pressure. This will take approximately 10-15 minutes.
 - 11) If you wish to Quick Release the pressure, move the Pressure Limiting Valve (3) to “Exhaust” position to release the pressure until the Float Valve (5) sinks. (Figures 15 & 16).
- **CAUTION: Use an oven mitt or long utensil. Keep hands and face away from Pressure Limiting Valve (3) while in the Exhaust position. Failure to comply may cause serious injury.**

- 12) Always make certain the pressure is released completely before unlocking the lid and opening it.
- 13) Press Cancel to end operation and remove food to serve immediately or leave food inside the pressure cooker to keep warm. (It is not recommended to keep food warm for over 4-hours).

At any point during the selection process or the cooking process, you can press the **CANCEL button to cancel your selection or to cancel the cooking process.

HOW TO USE THE **DELAY TIMER**:

If you wish to Program your pressure cooker to automatically cook prepared food at a later time, you can Program the pressure cooker to delay the start of cooking by up to 24-hours. (*See Notes & Tips #6). This setting is used in combination with the **MENU BUTTON SELECTIONS** in the chart shown on page 10 and with the **PRESSURE COOK TIME BUTTON**.

- 1) Prepare desired food and place into cooking pot.
- 2) Secure the Lid (2) onto the unit, turn it Counter-clockwise to lock it in place.
- 3) Make sure the Pressure Limiting Valve (3) is set to the "Airtight" position.
- 4) Plug the power cord into a 120V power outlet.
- 5) The LED screen will display **00 00**.
- 6) Press the **DELAY TIMER** button. The LED screen will show **0:30** which is equal to 30 minutes of delay time. Each incremental push of the **DELAY TIMER** button will increase the delay time by 30 minute increments (indicated on the LED screen). You can also hold down the **DELAY TIMER** button for rapid increase of delay time. The maximum Delay period is 24-hours. After 24-hours, the timer will start anew at 30 minutes. (The time that displays on the LED screen shows how long the user wants the unit to wait before the cooking process begins.
- 7) EX: If you wish to program the pressure cooker to automatically turn on in 3-hours, press the **DELAY TIMER** button until the LED screen displays **3:00**.
- 8) After choosing the desired Delay time, choose your **MENU BUTTON** or set your cooking time manually using the **PRESSURE COOK TIME BUTTON**.

MENU BUTTONS:

- 1) Press one of the 8 pre-programmed **MENU BUTTONS**. Follow the instructions under "How to use the MENU BUTTONS."
- 2) Once the desired **DELAY TIME** and **MENU BUTTON** are selected, the display will begin to countdown the **DELAY TIME**, the **DELAY TIMER** indicator light and the desired **MENU BUTTON** will illuminate and the unit will begin to countdown 3 hours until cooking begins.
- 3) Once the pressure cooker completes its countdown, the unit will begin to pressurize and follow the cooking sequence for the chosen **Menu Button** selection.

- 4) When cooking is complete, the pressure cooker will beep 3-times and automatically go to Keep Warm. The display will show **bb** during Keep Warm.
- 5) The Keep Warm indicator light will illuminate. This indicates the Pressure Cooker is Naturally Releasing the pressure. (See Notes & Tips #5).

PRESSURE COOK TIME BUTTON:

- 1) Press the desired **Menu Button** and then the **Pressure Cook Time** button to reach the desired cook time. Follow the instructions under "How to use the PRESSURE COOK TIME button."
 - 2) Once the desired **DELAY TIME** and **PRESSURE COOK TIME (under a specific MENU BUTTON)** are selected, the display will begin to countdown the **DELAY TIME**, the **DELAY TIMER** indicator light and the selected **MENU BUTTON** will illuminate and the unit will begin to countdown 3 hours until cooking begins.
 - 3) Once the pressure cooker completes its countdown, the unit will begin to pressurize and follow the cooking sequence for the chosen **Pressure Cook Time** selection.
 - 4) When cooking is complete, the pressure cooker will beep 3-times and automatically go to Keep Warm. The display will show **bb** during Keep Warm.
 - 5) The Keep Warm indicator light will illuminate. This indicates the Pressure Cooker is Naturally Releasing the pressure. (See Notes & Tips #5).
- **CAUTION: Use an oven mitt or long utensil. Keep hands, arms, and face away from Pressure Release Valve while in the Exhaust position. Failure to comply may cause serious injury.**

NOTES & TIPS #6:

- During the cooking process, when the pressure cooker enters into the Pressurized Sequence, the first digit on the LED screen will display the letter "P".
 - For foods with a high volume of liquid (Stews, soups, porridges, etc.) **IT IS NOT RECOMMEND TO USE QUICK RELEASE**. This is to avoid liquid splatter from the ventilation in the Pressure Limiting Valve (3).
 - Use NATURAL RELEASE: User should wait for the temperature to drop and the Float Valve to sink on its own prior to opening the lid.
- **CAUTION: It is not recommended to use the Delay Timer function to cook foods that may spoil. Leaving raw foods inside the pressure cooker for long periods of time prior to cooking may result in the food spoiling. Cook food that can be left out such as rice, beans, grains or other foods that will not spoil.**

HOW TO BROWN/SAUTÉ WITH YOUR PRESSURE COOKER:

Certain recipes suggest that you brown meat or sauté vegetables to ensure juices are retained during cooking. It also provides nice coloring when meat or vegetables are cooked and ready to serve. To brown or sauté:

1. Remove the pressure cooker Lid (2).
2. Select the **FISH & VEGETABLES** setting to manually begin the heating process.
3. Place food into the Inner Pot (4) and cook to brown or sauté to desired consistency.
 - *Note: You will need to press the **Keep Warm/Cancel** button to shut off the **BROWNING** function.
 - Allow the unit to rest 2-3 minutes after cancelling the **BROWNING** function before beginning to pressure cook.

HOW TO USE THE KEEP WARM FUNCTION:

Food can be prepared at an earlier time and kept warm inside the pressure cooker using the **Keep Warm** function. Food should not be kept warm for more than 4-hours. Additional time may cause a change in flavor, appearance and cause food to spoil.

- 1) Prepare desired food and place into cooking pot.
- 2) Secure the Lid (2) onto the unit, turn it Counter-clockwise to lock it in place properly.
- 3) Plug the power cord into a 120V power outlet.
- 4) The LED screen will display **00 00**.
- 5) Press the **Keep Warm/Cancel** button once. The **Keep Warm/Cancel** indicator light will illuminate solid and the display will read **bb**. It is recommended to set the Pressure Limiting Valve (3) to "Exhaust" at this time since you are only keeping food warm and not pressurizing.
- 6) The pressure cooker will start maintaining a lower temperature to keep warm.
- 7) To cancel, simply press the **Keep Warm/Cancel** button again until indicator light is no longer illuminated.
- 8) Remove food and serve.
- 9) Unplug power cord and allow to cool completely before dismantling and cleaning.

HOW TO COOK WITH FROZEN FOODS:

Cooking frozen food inside a pressure cooker is quick and easy but has certain restrictions. Only cook individual cuts of frozen meats that are up to 1 inch thick, the cooking time does not need to be altered. Pressure will not be achieved until the internal temperature has reached a preset level. If the recipe states the meat should be cooked for 10 minutes after pressure has been achieved, it will still be the same, but it will take longer to reach the required pressure point.

It is not recommended to pressure cook larger cuts of frozen meats such as a whole roast, a block of frozen ground meat or a whole chicken. Larger cuts will require increased cooking times of up to one third more, and the results may not be the same when compared to meats that were thawed (or at least partially thawed) and browned before cooking.

HOW TO USE THE PRESSURE COOKER FOR CANNING:

It is recommended to purchase a separate instructional book that is specific to Canning. These books can be purchased at a local book store. This pressure cooker can be used to do basic pressure canning and the water-bath method. Low-Acidic fruits and vegetables and High-Acidic fruits and vegetables are recommended. It is not recommended to can foods such as meat or seafood products in this unit. It is not recommended to use this pressure cooker for canning at high or low altitudes.

Before using this unit for canning purposes, check with the USDA for food preservation guidelines or read the publications listed at http://www.uga.edu/nchfp/publications/publications_usda.html.

- 1) Always use canning supplies specifically manufactured for canning purposes. It is recommended to use mason jars that are 32-ounces or smaller. Do not stack jars on top of each other.
- 2) Always inspect your canning supplies to ensure proper function and safety. Avoid using jars with chips, nicks, cracks or other imperfections in the glass, rims or lids.
- 3) Wash jars thoroughly in hot water according to manufacturer's instructions.
- 4) Prepare food and fill mason jars and seal according to manufacturer's instructions.
- 5) Always make sure there is 1-inch of headspace in the jars.
- 6) Use a thin utensil to release any trapped air between the food and the jar by pressing food firmly to the sides to dislodge any air bubbles.
- 7) Set jar lids onto the jar and screw on the outer rings until tight, then unscrew $\frac{1}{4}$ turn.
- 8) Place jars into the inner pot.
- 9) If desired, use clean dish towels to tuck around the jars to prevent them from touching each other or the sides of the inner pot.
- 10) Fill inner pot with 6-cups of water. (Certain canning recipes may require a different amount of water.)
- 11) Secure the lid onto the pressure cooker, turn it Counter-clockwise to lock it in place properly.
- 12) Make sure the Pressure Limiting Valve (3) is set to the "Airtight" position.
- 13) Plug the power cord into a 120V power outlet.
- 14) Follow canning recipe for the type of food you are canning and program the **Pressure Cook Time (under a specific Menu Button)** for the specified time frame for the size of jars and type of food recipe you are using by following the directions under **How to use the Menu Buttons** and **How to use Set Pressure Cook Time** in this manual.
- 15) When the unit has reached optimum pressure, it will begin to pressure-seal the mason jars. The programmed time will begin to count down until it reaches zero.

- 16) When time has expired, the pressure cooker will beep 3-times and automatically go to Keep Warm.
- 17) The Keep Warm indicator light will illuminate. This indicates the Pressure Cooker is Naturally Releasing the pressure. (See Notes & Tips #5)
- 18) Open lid once pressure has completely released.
- 19) Carefully remove jars using special canning utensils or tools. **CAUTION: Jars are hot!**
- 20) Set jars on a towel or cooling rack and allow to cool completely in a draft-free location.
- 21) Follow recipe instructions on cooling and storage.

NOTES & TIPS #8:

- While the jars are cooling, a small “click” sound will come from the lids to indicate the lids are sealing properly.
- After approximately one hour, check to be sure the flat lids have obtained a good seal by pressing down with your thumb; the lid should remain stiff with no movement.
- If you have not achieved a good seal within 2 hours, the canning did not work properly and the ingredients will need to be refrigerated and used within 3 days or frozen in a freezer container.

HOW TO CLEAN YOUR PRESSURE COOKER

- 1) Always make sure the Pressure Cooker is unplugged, depressurized and completely cooled down before dismantling.
 - 2) Use a non-abrasive sponge or damp wash cloth to clean the exterior of the outer body (13) and the exterior surface of the pressure cooker. **NEVER** immerse the pressure cooker in any liquids.
 - 3) Remove the Condensation Cup (12) and rinse it thoroughly and let dry. Clean the Upper Ring (9) with a damp sponge or wash cloth.
 - 4) Clean the Lid (2) with warm soapy water, including the Rubber Seal Ring (18), Pressure Limiting Valve (3), Filter (17), Vent, Float Valve (5) and let dry thoroughly.
 - The Pressure Limiting Valve (3) pops off easily by gently reaching underneath it and gently prying upwards. Be careful not to damage the thin wire spring under it.
 - On the underside of the lid below the Pressure Limiting Valve (3), is a small metal filter cap which can be removed easily to clean.
 - 5) Let parts dry completely before reassembling.
 - 6) Wash the Inner Pot (6) with a non-abrasive sponge and allow to air dry or use a towel. It is not recommended to use any type of scouring pad that can scratch the non-stick surface of the Inner Pot (6).
 - 7) Clean the Pressure Limiting Valve (3) and the holes with a small brush to ensure smooth flow of steam during the release cycle.
 - 8) Store the inner pot inside of the Pressure Cooker. Store Pressure Cooker in a cool, dry location.
- **NOTE:** Any servicing required shall be performed by an authorized service representative or from the original manufacturer or distributor.

FAQ (FREQUENTLY ASKED QUESTIONS)

- 1) **Is the Airtight/Exhaust Pressure Limiting Valve (3) on the top of the lid supposed to be loose?**
 - If you are not cooking or using the unit, the Valve (3) will be loose. It will turn 360 degrees and may even come off if you pull on it. Once you start using the pressure cooker and the pressure has built up, and the Valve is set to "Airtight" properly, it will not be loose anymore.
 - Sometimes during cooking and pressurizing, steam may escape from the Valve. It indicates the Valve is not seated properly/securely. Simply use tongs or similar utensil and gently/carefully adjust it so it is seated properly.

- 2) **When I choose a Menu Button (ex: Meat & Chicken), nothing happens? What's wrong?**
 - Nothing is wrong.
 - Make sure the Valve (3) on top is set to Airtight and the Lid (2) is locked securely. Once you have selected the Menu Button, simply leave the unit alone and it will start to heat up and build up pressure. This sometimes may take up to 5-10 minutes depending on what you're cooking.
 - Once the unit has built up enough pressure, the display will change to a countdown timer that displays your desired cooking time of the **Menu Button** you selected. This is the time the unit will start cooking the food. Pressurizing can take anywhere from 5 minutes up to 20 minutes depending on the quantity of food you are cooking.
 - The unit will then start to cool down and de-pressurize on its own. It will beep 3 times. The **countdown timer** will change to **bb** and the Keep Warm light will illuminate.
 - During this time, the food inside is still cooking. Depending on if you want your food to be cooked longer, you can allow the unit to naturally release the pressure by letting the unit sit. (Some meats will keep cooking once the pressure is released, so if you prefer your meat to be Medium or Medium-Rare, we suggest the quick release.)
 - Once the pressure has completely released, the floating valve will drop down. You can unlock the lid and open to check on your food.

- 3) **When I set the pressure using the Preset Menu Buttons, it will begin to build pressure and heat up, but in about 5-minutes the unit beeps 3 times and goes to Keep Warm and my food did not cook completely. What is happening?**
 - The unit is detecting that not enough liquid has been added to your recipe. The pressure cooker has an automatic over-heat prevention sensor that will automatically set itself to OFF or to Keep Warm

when it senses that no liquid is present so it does not over-heat. Make sure all pressure is released, open the lid and add in increments of 1/2 cup of liquid until the unit will properly cook.

- The unit is detecting that there is a leak in the pressure and that it is not sealed up properly. Check the unit thoroughly. Make sure the rubber gasket ring is in place, the lid is securely locked, and that the Valve on top of the lid is set to the "Airtight" position. Reset the unit by unplugging it. Wait 10-seconds and plug it back in. Program the unit again.

4) Steam is being released around the rim of the lid during the pressurizing sequence. How do I fix this?

- See Notes & Tips #2.
- The Rubber Seal Ring (18) did not make a proper seal. Cancel all the functions. Exhaust any remaining pressure and steam. Open the lid and remove it entirely. Check the Rubber Sealing Ring to make sure it is positioned properly. Rub a wet cloth along it to make sure it is clean of debris and it is smooth. Re-assemble the lid, lock it securely in place and restart the cooking process.

5) Steam is being released from the Pressure Limiting Valve (3) during the pressurizing sequence. How do I fix this?

- See Notes & Tips #2.
- The Valve (3) may not be positioned properly. Simply use tongs or similar utensil or oven mitt and carefully adjust it so it is seated properly. If the steam continues to release, you may need to Cancel all the functions. Exhaust any remaining pressure and steam. Remove the Pressure Limiting Valve and check the thin wire spring on the underside of it. Make sure it is not bent or loose. If steam still continues to escape, the Valve may be faulty and replacement or repair may be necessary. Please contact the manufacturer.

6) Pressurized Steam is being quietly released from the Floating Valve (4) area during the pressurizing sequence. How do I fix this?

- This may happen during the initial start-up of the Pressurizing Sequence. Simply use tongs or similar utensil or oven mitt and carefully adjust it so it is seated properly. This will help settle the lid and all the valves properly. The pressure will quickly push up on the Floating Valve and seal it properly then finish the pressurizing sequence.

7) My food is finished cooking and all the pressure is released, but I cannot unlock and open my lid. What is stuck?

- Make sure all the pressure and steam has completely been released. Make sure the small Floating Valve (4) is no longer in the up position. It may be stuck in the UP position, simply tap the lid slightly to make it go back down. Then turn the lid clockwise to unlock the lid. If it is still stuck, unplugging the unit may help.

8) What is the clear, round plastic part that came with my pressure cooker?

- It is the **Condensation Cup**: Refer to part (12) under **Parts**

Identification within this manual to attach the condensation cup to the side of the pressure cooker. This catches the water and steam that drips off the lid when the lid is opened in the upright position.

NOTES & TIPS #9:

- If recipes require the use of a trivet, riser (wire rack), foil, or heat-resistant/pressure-resistant oven-safe cookware, you may use these accessories in this pressure cooker.
- If you do not have a wire rack that will fit, simply use 3-4 mason jar lids or regular jar lids for a simple 1-inch riser.

COOKING TIME CHART

Courtesy of www.healthfoods.com

Please note that all the below information is for your reference only and can be adjusted according to the user's preference.

Meat/Poultry

- Always cook meat or poultry with at least 1-3 cups of liquid. If the cooking time exceeds 15 minutes, use 2 cups of liquid. If weight of meat or poultry is 3lbs, use 3 cups of liquid. Preserved or salted meats should be immersed in water.
- Cooking times for meat and poultry may vary according to the quality and quantity of meat or poultry being cooked.
- Unless indicated. The cooking times given below are for 3 pounds of meat or poultry unless noted otherwise. Additionally, the denser the cut, the longer the cooking time should be.

Type of Meat	Approximate Cooking Minutes	Pressure Release
Beef/Veal, roast or brisket	38-42	Quick Release
Beef Meatloaf, 2 lbs.	13-18 or use the Meat Button	Quick Release
Beef, meatballs, 1-2 lbs.	7-12 or use the Meat Button	Natural Release
Beef, Corned	55-65	Natural Release
Pork, roast	43-47	Natural Release
Pork, ribs, 2 lbs.	18 or use the Meat Button	Quick Release
Pork, ham shank	25-28	Natural Release
Leg of Lamb	42-45	Natural Release
Chicken, whole, 2-3 lbs.	15-18 or use the Meat Button	Quick Release
Chicken, pieces, 2-3 lbs.	12-15 or use the Meat Button	Quick Release
Cornish Hens, two	12-15 or use the Meat Button	Quick Release
Meat/Poultry soup/stock	15-20 or use the Meat Button	Quick Release

Seafood

- Cooking times may vary according to the type of seafood being cooked.
- Cook seafood on a cooking rack with a trivet on the bottom of the pot (if available), and add at least 3/4 cup of liquid. Lightly grease cooking rack with vegetable oil when cooking fish.

Type of Seafood	Approximate Cooking Minutes	Pressure Release
Clams	3-5	Quick Release
Crabs	3-5	Quick Release
Lobster, 1 1/2 - 2 lbs.	3-5	Natural Release
Mussels	3-5	Quick Release
Shrimp	2-3	Quick Release
Fish, whole, gutted	7-8	Quick Release
Fish, Soup or Stock	7-8	Quick Release

Vegetables

- Always cook with at least 1-2 cups of liquid.
- Add 1-2 additional minutes to cooking time when preparing frozen vegetables.
- Use the quick-release release method at the end of cooking cycle so vegetables will not become soggy. (Below chart is for quantity approximately half a pot).

Type of Vegetable	Approximate Cooking Minutes	Pressure Release
Asparagus, thick whole	2-5	Quick
Asparagus, thin whole	1-2	Quick
Beans, fava, shelled	5	Quick
Beans, green, whole	4-5	Quick
Beans, lima, shelled	3	Quick Release
Beets, small, whole	2-3	Quick Release
Beets, large whole	23	Quick
Beets, 1-inch slices	5	Quick
Broccoli, flowerets	3	Quick
Brussel sprouts, whole	5	Quick
Carrots, 1-inch chunks	5	Quick
Carrots, 1/4-inch slices	1-2	Quick
Cauliflower, flowerets	3-5	Quick
Corn on-the-cob (4-6)	4	Quick
Escarole, coarsely chopped	2-3	Quick
Kale, coarsely chopped	2-3	Quick
Okra, small pods	3-5	Quick
Onions, whole	3	Quick
Potatoes, 1 1/2-inch chunks	7	Quick Release
Potatoes, new, small whole	6	Quick Release
Potatoes, sweet and yams, whole, medium	10-12	Quick Release
Potatoes, sweet and yams, 2" chunks	7-8	Quick Release
Spinach, fresh, coarsely chopped	3	Quick Release

Squash, acorn, halved	8	Quick Release
Squash, butternut, 1-inch chunks	5	Quick Release
Squash, summer, zucchini or yellow, 1/2-inch slices	6	Quick Release
Turnips, small quartered	4	Quick Release
Turnips, 1 1/2 inch chunks	4	Quick Release

***Split peas and rhubarb can foam, froth, and sputter, and can clog the pressure release device (steam vent). These foods should not be cooked in a pressure cooker.**

Dried Beans and Other Legumes

- Place beans or legumes in pressure cooker. Add 3 cups of water for each cup of beans or legumes.
- Add 1 tablespoon of vegetable oil for each cup of water to cut down on foaming. Do not add salt until after cooking.
- Let pressure drop naturally after cooking.
- Cooking times may vary according to the quality of the beans or other legumes. If still hard after recommended cooking times, continue cooking uncovered. Add additional water, if necessary. (Below chart is for quantity approximately half a pot).

Type of Legume	Approximate Cooking Minutes	Pressure Setting
Azuki	7-8	Natural Release
Black Beans	10-12	Natural Release
Black Eyed Peas	11-12	Natural Release
Chick Peas (garbanzo)	11-13	Natural Release
Gandules (pigeon peas)	8-10	Natural Release
Great Northern	10-14	Natural Release
Kidney Beans, Red	12-14	Natural Release
Lentils, green	10-12	Natural Release
Lentils, soup	8-10	Natural Release
Lentils, red	10-15	Natural Release
Lima Beans	7-8	Natural Release

*** Applesauce and cranberries, can foam, froth, and sputter, and can clog the pressure release device (steam vent). These foods should not be cooked in a pressure cooker.**

Grains

Before cooking, soak certain grains, such as wheat berries and pearl barley in four times their volume of lukewarm water for at least four (4) hours or overnight if required. Do not add salt to water, since it may toughen the grains and inhibit hydration.

- Do not soak rice.
- Rinse under lukewarm water (this also applies to rice)
- Cook each cup of grain in the amount of water specified.

Type of Grain	Approximate Cooking Minutes	Pressure Setting
Rice, basmati – 1 1/2 cups	7-8	Natural Release
Rice, converted – 1 1/2 cups	7-8	Natural Release
Rice, long grain – 1 1/2 cups	7-8	Natural Release
Rice, brown – 1 1/2 cups	17-22	Natural Release
Rice, wild – 3 cups	25-27	Natural Release
Wheat, berries – 3 cups	1	Natural Release

*** Pearl barley, oatmeal or other cereals can foam, froth, and sputter, and can clog the pressure release device (steam vent). These foods should not be cooked in a pressure cooker.**

RECIPES

Recipes are courtesy of Joelle Hunter.

MACARONI N' CHEESE

SERVES 8

Ingredients

2 Tbsp butter
2 shallots, minced
12 cups water
2 Tbsp seasoned salt
1 Tbsp Worcestershire sauce
1 Tbsp dry mustard
3 pounds elbow noodles (or your favorite small pasta)
1 loaf original Velveeta, cut into cubes
2 cups shredded mozzarella cheese
2 cups shredded cheddar cheese
1/2 jar diced pickled jalapeños

Turn on pressure cooker to fish/vegetables and remove lid. Melt butter and sauté shallots for 2-3 minutes. Add water, salt, Worcestershire sauce, dry mustard & pasta and cook under pressure for 1 minute. Release pressure, open lid and add cheeses & jalapeños; stir well. Close lid and let cheese melt for 2-3 minutes, then stir again. (For extra creamy "TV" Mac & cheese, stir in 2 cups whole milk, half & half or heavy cream at the end).

WHOLE TURKEY

SERVES 8

Ingredients

12LB Turkey or smaller
Olive Oil for Rub
Salt
Pepper
Poultry Seasoning

Pat turkey dry with paper towels, then rub with oil and sprinkle generously with salt, pepper & poultry seasoning. Place on a sheet pan in a pre-heated 450°F oven for 15 minutes. (You may stuff turkey before placing in oven, if desired).

While turkey cooks in oven, create a "sling" for easy removal of Whole Turkey from the pressure cooker: Fold two 24 inch long sheets of aluminum foil each in half lengthwise and then in half again so they are about 2 inches wide. Place both in bottom of pressure cooker in an X with long sides hanging out of the pot. Place the turkey with legs up and leaning over to one side onto the foil sling. Add 1 cup chicken broth and cook under pressure for 1 hour.

Recipes are courtesy of www.recipezaar.com and www.fastcooking.ca.

Please note that all of the information is for your reference only and can be adjusted according to the user's preference.

MEAT/CHICKEN RECIPES:

BEEF IN PEPPER SAUCE

SERVES 4

Ingredients

Pepper Sauce

- 1 red bell pepper or green bell pepper
- 1/2 cup baby carrot
- 1 (8 ounce) can tomato sauce (1 tbsp to be use later)
- 2 garlic cloves
- 2 teaspoons ground ginger
- 1 teaspoon turmeric
- 1 teaspoon salt
- 1/2 teaspoon black pepper
- 1/2-1 teaspoon cayenne pepper (depends on how spicy you like it)
- 1/2 teaspoon ground cardamom
- 2 tablespoons olive oil

2 lbs boneless sirloin steaks, cut into strips

salt & pepper

1 cup water

1/2 teaspoon paprika

1/2 teaspoon cumin

1/2-1 onions, sliced

1 green bell pepper, sliced

Directions

- Remove 1 tablespoon of tomato sauce from the can to be used later. Then blend the ingredients for the pepper sauce (green pepper through cardamom) in a food processor until there are no chunks left. Set aside.
- In a skillet over medium heat, add enough olive oil, sprinkle the beef with salt & pepper then brown over heat. Once brown, remove from heat.
- In the cooking pot, add the beef, water, reserved tomato sauce, paprika & cumin. Close and lock the pressure cooker lid. Adjust the pressure valve on top to Airtight and press the MEAT function switch.
- When the pressure cooker has finished the cooking cycle, release all the pressure by carefully setting the valve to Exhaust on the top of the lid. Once all the pressure has released, the lid can be turned and unlocked.
- Add the pepper mixture, sliced onions & green peppers to the meat and sauce, close and lock lid and press the MEAT & CHICKEN function again.
- When the pressure cooker has finished the cooking cycle, release all the pressure by carefully setting the valve to Exhaust on the top of the lid. Once all the pressure has released, the lid can be turned and unlocked.
- Vegetables and meat should be tender. Serve immediately over white rice if desired.

CHICKEN PICCATA

SERVES 6

Ingredients

6 chicken breast halves	1 cup pimento stuffed olive, minced
1/2 cup all-purpose flour	1/4 cup sour cream
1/4 cup olive oil	1 tablespoon potato starch or flour
4 shallots	1/4 cup fresh parmesan cheese, fontinella
grated (1 ounce) o 3 garlic cloves, crushed	
cheese, grated	
3/4 cup chicken broth	1 lemon, thinly sliced, to garnish
1/3 cup fresh lemon juice	1 teaspoon dried basil
1 tablespoon sherry wine	
2 teaspoons salt	
1/4 teaspoon white pepper	

Directions

- Lightly dust chicken pieces with flour. In a large skillet over medium heat, heat oil. Add chicken breasts, two at a time, and sauté in hot oil until brown on all sides. Remove from skillet and set on a paper towel lined dish.
 - Add shallots and garlic to the skillet and sauté for 3 to 5 minutes, scraping bottom of skillet to loosen browned particles remaining from chicken. Stir in broth, lemon juice, sherry, salt, pepper, basil, and olives. Mix well then remove from heat.
 - In the cooking pot, add chicken pieces skin side down then add the liquid from the skillet. Close and lock the pressure cooker lid. Adjust the pressure valve on top to Airtight and press the MEAT & CHICKEN function switch.
 - When the pressure cooker has finished the cooking cycle, release all the pressure by carefully setting the valve to Exhaust on the top of the lid. Once all the pressure has released, the lid can be turned and unlocked.
 - Stir chicken mixture, then transfer just the chicken to serving platter, and cover to retain heat.
 - Whisk sour cream and starch together. Stir into cooking liquid inside the pressure cooker and cook over manual heat 1 minute, stirring constantly.
 - Spoon sauce over chicken. Sprinkle with cheese and garnish with lemon slices.
-

SPARE RIBS
SERVES 6 -8

Ingredients

1 cup brown sugar
1/4 cup soy sauce
1/2 teaspoon paprika
1 tablespoon vinegar
1/4 teaspoon cayenne
1 teaspoon garlic powder
2 lbs pork ribs
1 cup of chicken/beef stock

Directions

- Prepare sauce ingredients inside cooking pot.
 - Divide ribs up evenly so it fits into the pressure cooker.
 - Coat each piece thoroughly with the sauce.
 - Place all ribs into pressure cooker pot after coating with sauce.
 - Add the 1 cup of stock to the bottom of pot.
 - Close and lock the pressure cooker lid. Adjust the pressure valve on top to Airtight and press the PORK function switch.
 - When the pressure cooker has finished the cooking cycle, release all the pressure by carefully setting the valve to Exhaust on the top of the lid. Once all the pressure has released, the lid can be turned and unlocked.
-

TRADITIONAL MEAT LOAF
SERVES 4

Ingredients

1 1/2 lb mixture of chopped or pepper	Freshly ground
ground lean beef, pork and veal water and squeezed dry	2 slices bread, soaked in
1 teaspoon salt	2 tablespoons parsley
1 medium onion, minced 1 garlic clove	1 egg
2 tablespoons chicken stock	1 cup tomato sauce
2 teaspoons Worcestershire sauce	1 cup water
2 tablespoons olive oil	

Directions:

- In a bowl, combine the chopped meat, salt, pepper, bread, parsley, onion, garlic, egg, chicken stock and Worcestershire sauce. Shape into two small loaves. Wrap each in wax paper and chill several hours to firm. In a skillet over medium heat, add the oil and brown the loaves well on all sides. Remove and set on oven-safe dish that will fit into the pressure cooker.
- Pour off the oil and combine the tomato sauce and water, and season with salt and pepper. Spread the ketchup over the meat loaves and lower the oven-safe dish into the pressure cooker.

- Close and lock the pressure cooker lid. Adjust the pressure valve on top to Airtight and press the MEAT & CHICKEN function switch.
 - When the pressure cooker has finished the cooking cycle, release all the pressure by carefully setting the valve to Exhaust on the top of the lid. Once all the pressure has released, the lid can be turned and unlocked.
 - Remove dish using a removing utensil/tool. Slice and serve immediately.
-

JAMBALAYA

SERVES 4-6

Ingredients

1 tablespoon vegetable oil
1/2 lb boneless skinless chicken breasts, cut into 1" pieces
1/2 lb fully cooked Andouille or Italian sausage, sliced
1/2 lb uncooked shrimp, peeled and deveined
2 teaspoons Creole seasoning
1 teaspoon dried thyme leaves
1/8 teaspoon cayenne pepper
1 onion, chopped
3 garlic cloves, minced
1 green bell pepper, chopped
3 stalks celery, sliced
1 cup long grain rice
16 oz canned chopped tomatoes, un-drained
1 cup chicken stock
3 tablespoons fresh parsley, minced

Directions:

- In a large skillet over medium heat, add oil and add chicken, sausage and shrimp. Sprinkle half of the Creole seasoning, half the thyme and half the cayenne. Cook for 3-5 minutes uncovered, stirring frequently, until chicken and shrimp are thoroughly cooked. Remove chicken, sausage and shrimp with a slotted spoon and set aside.
 - Add onion, bell pepper, celery and remaining Creole seasoning, thyme and cayenne to skillet and cook for 4-5 minutes, stirring frequently then remove from heat.
 - In cooking pot, add chicken, sauce, shrimp and rice, tomatoes with their juice and stock.
 - Close and lock the pressure cooker lid. Adjust the pressure valve on top to Airtight and press the SOUP & STEW function switch.
 - When the pressure cooker has finished the cooking cycle, release all the pressure by carefully setting the valve to Exhaust on the top of the lid. Once all the pressure has released, the lid can be turned and unlocked. Serve with rice if desired.
-

CORNISH HENS BRAISED IN WHITE WINE

SERVES 4

Ingredients

2 tablespoons olive oil	1 tablespoon minced parsley
2 Cornish hens, trussed	1 tablespoon flour
1/2 teaspoon salt	1/2 cup dry white wine
1/4 teaspoon freshly ground black pepper	1/2 cup chicken stock
1/2 teaspoon thyme	1/4 lb mushrooms, cleaned and sliced
1/2 teaspoon basil	

Directions:

- In a large skillet over medium heat, heat the olive oil and brown the Cornish hens on all sides. Sprinkle them with salt and pepper, thyme, basil and parsley. Remove from heat.
- In cooking pot, stir in the flour, and then pour in the wine and stock and add the hens.
- Close and lock the lid and following the instructions for "How to use the Pressure Cook Time button" on page 10 of this manual, program the pressure cooker for 40-minutes.
- When the pressure cooker has finished the cooking cycle, release all the pressure by carefully setting the valve to Exhaust on the top of the lid. Once all the pressure has released, the lid can be turned and unlocked. Serve with rice or a salad if desired.

Recipes courtesy of www.peggyunderpressure.com

SEMI-ROASTED & PRESSURE COOKED THANKSGIVING TURKEY

SERVES 6

Prep the turkey to your desired preference to roast it in the oven or, you can try this simple Herb Butter Recipe for a whole 12lb turkey. The butter will help the turkey brown quicker in the oven. Make sure the turkey is placed inside a roasting pan. Preheat your oven to 450F.

HERB BUTTER INGREDIENTS:

1 Cup Butter (room temperature)	1/2 Tsp Pepper
1 Tsp Garlic Powder	1 Tsp Dried Basil
1/2 Tsp Salt	1 Tsp Dried Rosemary
1/2 Tsp Lawry's Seasoning Salt	1 Tsp Dried Parsley

Mix all ingredients with the butter so it becomes a nice gooey paste. Melt it in the microwave for about 15-seconds if the butter is too firm. Using a brush, smear the herb butter all over the turkey. Cover as much of it as possible. Get it under the skin and onto the bottom and inside the cavity.

OVEN ROASTING TURKEY INGREDIENTS:

1/2 Half Large Yellow Onion	2 Sprigs Fresh Thyme
2 Sprigs Fresh Sage	4 Whole Garlic Cloves
2 Sprigs Fresh Rosemary	

Chop up the onion into quarters and stuff it into the cavity of the turkey. Leave the herbs whole and also stuff it into the cavity. Put the turkey into the oven and roast for only 30-minutes or until the skin is nice and golden brown.

Once that's done, take it out of the oven and set it aside to cool down slightly. Now starts the hard work of hacking it into pieces. If you have an electric knife, this is the time you'll need it. It'll be a life saver! Keep the legs/drumsticks, wings and even the breast whole when you carve them off. Remove as much of the turkey meat as you can. The center of the turkey will still be pretty raw. So this carving work is not going to be a pretty one.

PRESSURE COOKING TURKEY INGREDIENTS:

1/2 to 1 Can Chicken Stock

1/2 Large Yellow Onion

Plus:

The onions and fresh herbs from the turkey cavity

Turkey Juices from the roasting pan

Any leftover herb butter

Place all the pieces into the pressure cooker pot. It should all fit nicely now. Use the other half of the remaining onion you chopped earlier and put it into the pot as well. Dig out the onions and the herbs from the cavity and place in the pot and pour any of the juices from the roasting pan in as well. And any remaining herb butter from earlier.

Pour in one can of Chicken Stock. Perhaps even half a can will do. The turkey itself releases a lot of liquid, so don't overfill. You don't need to immerse the entire turkey into liquid.

Shut the lid and turn to lock it into place. Adjust the pressure valve on top to Airtight. Following the instructions for "How to use the Pressure Cook Time button" on page 10 of this manual, program the pressure cooker for 45-minutes.

At this time you can prepare some items that you can use to "beautify" the turkey platter for your Thanksgiving dinner. For instance, you can prepare some fresh herbs or sliced oranges or lemons. Turkey that is cooked in the pressure cooker does not necessarily come out of it looking very "pretty". In fact, it takes some gentle-loving skill to remove it later without it all falling apart!

When the pressure cooker has finished the cooking cycle, release all the pressure by carefully setting the valve to Exhaust on the top of the lid. Once all the pressure has released, the lid can be turned and unlocked.

Using a pair of tongs, carefully and gently remove all the turkey sections. Use two pairs of tongs if you must. The liquid that's in the pot is also rich in flavor, perfect for making gravy if you like. Plate the turkey sections onto your serving platter. Hide all the mini loose pieces underneath the larger sections. Decorate the platter with fresh herbs and citrus slices. Ladle some extra liquid from the pot over the turkey and serve.

SOUTHERN TANGY PULLED ROAST BEEF

SERVES 4

INGREDIENTS:

3-4 Lb. Chuck Roast
1 Packet of Ranch Dressing Powder
1 Packet of Au Ju Mix Powder
2 to 4 oz butter (half a stick or 1 stick)
1 Jar of Pepperoncinis

Place about 4 peppers into the bottom of the cooking pot first. Then place the chuck roast on top of them. This will lift up the roast off the bottom of the pan and prevent burning and overheating.

Open the packets of the seasonings and sprinkle them both all over the top of the roast, covering it as much as possible. Place a few more pepperoncinis on top of the roast, and around it. Then pour about 1/4 to 1/2 of the pepperoncini liquid into the pot. Add 1/2 a cup of water to that, put the whole piece of butter directly on top of the roast as well and you are DONE!

Following the instructions for "How to use the Pressure Cook Time button" on page 10 of this manual, program the pressure cooker for 60-minutes.

You can serve this roast any way you like it. It's got a tangy spicy kick to the taste buds. I shredded the meat since it was falling apart anyway. Sprinkled some cheese on top and sandwiched it in between Hawaiian Sweet Dinner Rolls since that's all I had laying around anyway. Enjoy!

BALSAMIC CHICKEN AND ONIONS

SERVES 4

INGREDIENTS:

2 lbs. Chicken Thighs (You can use chicken breast to cut down on the calories.)
1 Ham Hock (I used this because the recipe called for Pancetta, and I didn't have any. Oops)
2 Cups Chopped Carrots (Frozen or fresh, but don't use baby carrots!)
2 Cups Pearl Onions (Frozen or fresh)
1 Cup Dried Mixed Berries (You can use any kind, a mix or just golden raisins.)
2 Bay Leaves
4 Cloves of Garlic
1 Cup Balsamic Vinegar
1 Cup Red Wine Vinegar
1/2 Cup Chicken Broth (You can honestly omit this ingredient since the chicken itself releases a lot of liquid already.)

Season the chicken on both sides with salt and pepper. Then put the ham hock and the chicken down first into the bottom of the inner cook pot. Put all of the remaining ingredients into the pot. The chicken will brown a bit on the side that is touching the bottom of the pot.

Close and lock the lid on your pressure cooker. Make sure the Pressure Valve is set to Airtight.

Press the MEAT & CHICKEN program button on your machine OR you can follow the instructions for "How to use the Pressure Cook Time button" on page 10 of this manual, and program the pressure cooker for 17-minutes.

When the pressure cooker gives you the signal, *beep beep*, it's time to release the pressure. Carefully turn the Pressure Valve on the top to EXHAUST and wait for all the steam and pressure to release. The Float Valve will drop, allowing you to unlock the lid.

You'll notice that the level of liquids inside the pot has almost doubled. Use a pair of tongs and carefully remove all the chicken. Set the chicken aside and go back to the remaining sauce. Ladle out or pour out about half of that liquid and return it back to the pressure cooker to reduce/thicken the sauce. Press the START button to turn on the heating system. Reduce the sauce so it becomes nice and thick. Help it along by adding flour or cornstarch if you like.

Once the sauce is thickened to the desired consistency, return the chicken carefully back into the sauce. Set the pressure cooker to Keep Warm until it's ready to serve. Serve it with rice or mashed potatoes.

SPANISH CHORIZO OXTAILS

SERVES 5-6

INGREDIENTS:

3 lbs Oxtails
1/4 lb of cured Chorizo, chopped
1 can whole Tomatoes
1 cup Red wine
1 large Onion, chopped
4 medium Carrots, chopped
4 Garlic cloves, chopped
2 Bay leaves
1 tsp Paprika

SERVE WITH:

Chopped Parsley or Chopped Green Onions
Splash of Red Wine Vinegar or Apple Cider Vinegar
Place the oxtail into the main cooking pot of your pressure cooker. Then add the rest of the ingredients into the pot in no particular order, however, put the carrots in last so it sits at the top. Avoid stirring and mixing. Lock the lid by turning it and adjust the pressure valve to Airtight. Following the instructions for "How to use the Pressure Cook Time button" on page 10 of this manual, program the pressure cooker for 40-minutes.

When the cooking cycle is complete, let the pressure cooker drop down in pressure naturally by itself. Once all the pressure has dropped, on my pressure cooker, the flashing Keep Warm light will stop flashing and become solid. Just in case, I turn the Pressure Valve to "Exhaust" to see if there is any

remaining pressure. Make sure the Float Valve has dropped as well. Now it's safe to turn the lid to open it. Give everything a gentle stir.

Serve with white rice. Add a splash of Red Wine Vinegar and chopped green onions or parsley. The vinegar actually cuts through the bold flavors and give it a tangy-ness to it. The oxtail meat falls off the bone and melts in your mouth and the chorizo adds a soft and spicy texture. The paprika also adds a bit of smoky flavor. **Note:** You can substitute the oxtail for stew meat such as beef chunks and also cook for 40-minutes.

BRAISED PORK BELLY

SERVES 4

INGREDIENTS:

3lbs. Pork Belly
1 thumb of Ginger, peeled and thinly sliced
3 stalks of Scallion/Green onion, chopped into 2" lengths
4 cloves of Garlic, peeled
4 Star Anise
4 Cloves
1/2 cup Soy Sauce
1/2 cup Dark Soy Paste
1/2 cup Shaoxing Hua Tiao Wine
1/2 cup Brown Sugar

FOR SCALDING:

2-3 cups boiling water

In a saucepan over medium heat, add a bit of cooking oil. Sauté the ginger, scallions, garlic, star anise and cloves until fragrant. Remove from heat. Using a very sharp knife, slice the pork belly into 1-inch slices. Place them all into a shallow pot or pan and scald them with boiling hot water. Set aside. Now slowly add the rest of the wet ingredients one by one to the saucepan and then the brown sugar. Mix everything until the mixture becomes a thick pasty consistency similar to BBQ sauce. If it's too watery, add more brown sugar.

Back to the pork belly, drain them of the hot water. Place each piece into the pressure cooker and add the sauce. Make sure they are thoroughly drenched in the sauce mixture. Ensure all the pieces are submerged before you shut the lid. Close and lock the lid and following the instructions for "How to use the Pressure Cook Time button" on page 10 of this manual, program the pressure cooker for 30-minutes.

When the cooking cycle is complete, let the pressure cooker drop down in pressure naturally on its own. When it is safe to open the lid, unlock and carefully remove all the pieces out with a pair of tongs.

The remaining sauce will be a lot more watery now because of the juices from the meat. We're going to reduce the sauce mixture into a nice thick

paste. Make a flour roux with a bit of the liquid ladled out in a little bowl, mix a bit of flour with it until smooth and pour it back into the pot. You can serve the pork belly over white rice. Ladle the sauce onto the meat and garnish with chopped green onions.

HAWAIIAN BBQ CHICKEN

SERVES 4

INGREDIENTS:

3lbs. Chicken (Frozen or Fresh; Breast, Thighs, Wings or Drumettes)

1 Cup BBQ Sauce

2 Cups Diced Pineapples (Canned or Fresh)

1 Cup Coconut Milk

1 Tbsp Chili Flakes (Of more if you like more kick)

Shredded Coconut (garnish)

Juice of Limes (garnish)

Mix the BBQ Sauce, Coconut Milk and Chili Flakes together. In the main cooking pot of your pressure cooker, place the pineapples down at the very bottom. This will be closest to the heat source and will therefore render out the pineapple juice so the pressure cooker will use the juices to steam up and pressurize since the BBQ sauce mixture is quite thick and may burn if you place it on the very bottom.

Start dipping your chicken pieces in the BBQ sauce mixture, a thin coat is fine. Add them into the pot one by one. Pour the remaining sauce mixture over the chicken when you're all done. Shut the lid of the pressure cooker, turn to lock it. Set the pressure valve to Airtight. Following the instructions for "How to use the Pressure Cook Time button" on page 10 of this manual, program the pressure cooker for 10-minutes.

Once the cooking cycle is finished, your pressure cooker will beep and let you know that the chicken is ready. Release the pressure and unlock the lid. The chicken and the pineapples will release a lot of juices during the pressure cooking process so there will be lots of liquid inside. Remove just the chicken with a pair of tongs and set aside temporarily. At this time, you can use a potato masher and mash down the pineapples so they become pulpier. (If you want the sauce extra thick, you can also make a flour roux with a bit of the liquid ladled out in a little bowl, mix a bit of flour with it until smooth and pour it back into the pot.)

Once the sauce has thickened to your desired consistency, put all the chicken back in. Now it's ready to serve with rice or eat it on its own. Garnish with a healthy heap of shredded coconut and a squeeze of lime juice.

ITALIAN POT ROAST

SERVES 4

INGREDIENTS:

3-lbs Beef Rump Roast (Cut into 2" chunks; you can choose to leave the roast whole, but cooking time will be 60-75 minutes)

1 Jar/Can of Roasted Red Bell Pepper

1 Jar/Can of Sun Dried Tomatoes in Olive Oil

1 Jar/Can of Marinated Artichokes in Water

1 Whole Onion (Finely Sliced)

4 Whole Garlic (Minced)

1 Package of Mushrooms (Chopped)

2 Tbsp Italian Seasoning

Remove the fat from the roast and use a sharp knife to cut the meat into whole 2 inch chunks. We're going to precook the meat in the pressure cooker first to do a "wash". This removes all the unwanted grime and gristle from the meat so it leaves the end result cleaner.

Place all the meat into the pressure cooker and pour in 3-4 cups of water. Season with salt and pepper if you wish. Shut the lid and lock it into position. Set the valve to AIRTIGHT and following the instructions for "How to use the Pressure Cook Time button" on page 10 of this manual, program the pressure cooker for 10-minutes.

When the pressure cooker is pressurized and cooks for 10-minutes, it'll automatically beep and go to Keep Warm. You can release the pressure by setting the pressure valve to EXHAUST. Remove all the meat into a bowl. Discard all the grimy water. Rinse the meat in the bowl to remove any remaining residue and then put the meat back into the cooking pot of the pressure cooker again.

Now you can add all the remaining ingredients in with the meat. Julienne the bell peppers, and chop the artichokes. Leave the sun dried tomatoes as is unless they are huge and need chopping as well. Include all the olive oil and water from the jars of bell peppers, sun dried tomatoes and artichokes. Do not drain. Pour them all into the pressure cooker pot. Add the onions and mushrooms and garlic. Add the Italian Seasoning and any other herbs you wish to add.

Lock the lid and set the pressure cooker to cook for an additional 20-minutes. Let the pressure cooker do its thing and when it's done, you know the drill. Release the pressure before opening the lid.

You can use the cooking juices from the cooking to make gravy. Use a slotted spoon and ladle out all the meat and vegetables, and put them into a separate serving platter. In a small bowl, mix half a cup of water with 1 tbsp of flour and mix until it becomes a runny white goo. Stir it while slowly pouring in the flour mixture and keep stirring and simmering until the gravy becomes a nice thick consistency.

That's it. Turn the pressure cooker OFF and serve your pot roast over mashed potatoes or some pasta or with a side of roasted potatoes. Top with the fresh gravy.

SAUCY STEAKS & CHEESY BROCCOLI GNOCCHI

SERVES 4

INGREDIENTS:

4-6 6oz Steaks. (8oz ones are okay too.)
1 Onion, sliced
1 Cup Beef Gravy
2-3 Cups Gnocchi

1/2 Cup Water
1 Cup Shredded Cheese
1 Cup Chopped Broccoli

Add the 1-cup gravy in the cooking pot, then place the Steaks over the gravy, making sure to coat each side. Top it with the sliced onions. **Note:** If desired, you can add some sliced mushrooms also.

Using a small stainless steel pan w/o handles, small enough to fit inside the inner pot and fill the pan with the half cup of water. Add the gnocchi to the pan. Place a trivet into the cooking pot over the steak and put the pan of gnocchi onto the trivet. Shut the lid and turn to lock it into position. Adjust the Pressure Valve to the "Airtight" position. Following the instructions for "How to use the Pressure Cook Time button" on page 10 of this manual, program the pressure cooker for 10-minutes.

Prepare the broccoli and cheese. Chop up the broccoli into smaller bite-size florets, add to a small bowl and mix in the cheese. Set aside until the pressure cooker is ready for them.

Once the pressure cooker has finished pressure cooking steaks and gnocchi, it will beep and automatically go to Keep Warm. Using an oven mitt, carefully turn the Pressure Valve on the top to "Exhaust" so all the pressure releases. As soon as the float valve drops, you turn to unlock the lid. Lift up the lid carefully and lift out the pan with the gnocchi. Shut the lid again so the heat inside the machine does not get lost.

Quickly drain all the water from the gnocchi. Toss the broccoli and cheese in with the gnocchi and put the whole pan back into the pressure cooker again. Shut the lid and leave it at Keep Warm for about 5-minutes. The broccoli will steam inside and the cheese will melt using all the retained heat and keep warm function. If the broccoli needs a bit more time, leave it in longer. Once it is ready, give the cheese, broccoli and gnocchi a good mix and remove the pan. Remove the steaks and serve with the gravy and onions. Add a side of the gnocchi and dinner is done!

ST. PATRICK'S BANGERS AND MASH

INGREDIENTS:

1 Package of 6-8 Bangers (Pork Sausages or whatever sausage you like)
5-6 Baking Potatoes (Peeled and Diced)
1 Cup Milk
1/2 Cup Butter
Salt & Pepper
1 Whole Onion (Sliced into rings)

FOR THE POTATOES:

1/2 Cup Sour Cream
1/2 Cup Parmesan Cheese

OTHER EQUIPMENT:

Potato Masher
Sheet of Foil

Peel and dice up the potatoes and put it in the bottom of the pressure cooker pot. (You can leave the peels on, just scrub them real well if you do.) Lightly toss them with salt and pepper. Add the cup of milk. Slice tabs of the butter and place them over the potatoes. Carefully lay a sheet of foil over the potatoes and put all the sausages onto the foil and make sure they do not risk rolling off. Top the sausages with the onions.

Shut the lid and secure into place. Adjust the pressure valve to "AIRTIGHT" and following the instructions for "How to use the Pressure Cook Time button" on page 10 of this manual, program the pressure cooker for 20-minutes. Once the pressure has been reached, the letter P will appear on the screen, the float valve will pop up and the heating element will shut off automatically. The 20-minutes will begin to count down and the internal hot pressure will continue to cook the food.

Once the allotted time has expired, the machine will beep and go to keep warm automatically. You can choose to either release all the pressure manually or let it drop down naturally. I prefer manually. So flip the top black knob valve that says Airtight/Exhaust to Exhaust and all the pressure will start to release. When all the pressure has released, the float valve will drop down and allow you to turn and open the lid.

Remove the sausages in the foil. You'll notice that the sausages are cooked but look grey and unsightly. Don't worry, they're just steam cooked and look kind of blah, but they still taste just fine. Now onto the mashed potatoes. Start mashing them carefully with a potato masher directly inside the pressure cooker pot. Add more milk, salt or butter if you prefer to get the potatoes to the consistency you like. To serve, you can slice up the sausages instead of leaving them whole if you prefer.

WHOLE CHICKEN AND VEGETABLES

SERVES 4

INGREDIENTS:

1 Whole Chicken

1 Cup Chicken Broth

2 Bags of Frozen Vegetable Medley Mix (Any will do, pre-seasoned or flavored works great)

Pour the chicken broth into the main cooking pot of the pressure cooker. Season the chicken with salt and pepper and place into the pot as well. Take one bag of the frozen vegetable mix and toss it into the pot. Program the pressure cooker to cook for 30-minutes and press Start. Reserve the second bag of vegetables for after the cooking cycle is complete. Throw that mix in and add an additional 5-minutes. Prepare rice, mashed potatoes, spaghetti or other pasta to serve with the chicken.

APPLES AND ONION PORK TENDERLOIN

SERVES 4

INGREDIENTS:

3-5 lb. Pork Rump or Pork Tenderloin

3 Apples (Sliced)

1 Whole Onion (Sliced)

2 Bay Leaves (Not pictured)

2 Cups Apple Juice

1 Cup Broth (Chicken, Beef or Vegetable, doesn't matter)

Salt & Pepper to taste

Remove any unwanted fatty pieces from the pork. Season it with salt and pepper on both sides.

Place all the onions and apples into the cooking pot. Pour in the apple juice and broth. Place the pork rump directly into all of that sweet goodness.

Shut the lid and turn it to lock it into place.

Make sure the Pressure Valve is set to Airtight. " Following the instructions for "How to use the Pressure Cook Time button" on page 10 of this manual, program the pressure cooker for 60-minutes. It'll take 5-10 minutes for the machine to heat up and build up the pressure. Once it reaches pressure, the letter P will display on the red digital read-out. And the 60-minute cook time will begin to count down.

When the pressure cooker is finished with the cooking cycle, it will beep and automatically go to keep warm. At this point, you can manually release the pressure by or allow it to Natural Release. Once the float valve has dropped and the lid is safe to open, unlock and lift the lid up. Release any remaining pressure and turn to open the lid. The onions and apples will pretty much melt as soon as you stir the contents. The pork is super juicy and tender. Slice it into thick slices and serve over mashed potatoes or stuffing with some of the apple and onion gravy.

CODA ALLA VACCINARA – BRAISED OXTAIL RAGU

SERVES 4

Coda alla Vaccinara is a popular Italian stew/ragu that originated from Rome. It is made with red wine and oxtail (or sometimes veal tail), plus miscellaneous vegetables. It is commonly served with pasta, polenta, or gnocchi.

INGREDIENTS:

4 lbs. of Oxtail
3 Cup of Water
3 Cup of Red Wine
1 Cup of Chopped Celery
1 Cup of Chopped Onion
1 Cup of Chopped Panchetta
1 Cup of Chopped Tomatoes or Canned Stewed Tomatoes
2 Tbsp Freshly Chopped Garlic
1 Cup of Beef Stock or Beef Bouillon
4-6 Cloves or Star Anise
2-4 Bay Leaves
Salt & Pepper to taste

Pre-cook the oxtail in just plain water first for about 5 minutes in the pressure cooker. What this does is get all the grime and meat residue cooked off the meat and float in the water. It makes it easier to discard all that gunk so they aren't floating around in the stew later. Trim off as much as the fat from the oxtail as you can. Then place all of it into the pressure cooker pot. Add about 3 cups of filtered drinking water. Close and lock the lid. Adjust the Pressure Valve to "Airtight". Following the instructions for "How to use the Pressure Cook Time button" on page 10 of this manual, program the pressure cooker for 5-minutes.

During this time, you can prepare all the vegetables and other ingredients.

When the pre-cooking of the oxtail is complete, you can release the pressure. After ALL of the pressure is released, open the lid and remove the cooking pot. Drain all the water from inside and rinse the oxtail so all the gunk and grime is washed away. Put all the oxtail back into the main cooking pot and add all the other remaining ingredients.

Remember, the amount of liquid in this recipe is not very much compared to the Oxtail Vegetable Soup I've made before. (The consistency of this dish should be thick, so reducing the liquid later in the cooking cycle may be necessary.)

Turn the lid and lock it into position. Adjust the pressure release valve to AIRTIGHT. Following the instructions for "How to use the Pressure Cook Time button" on page 10 of this manual, program the pressure cooker for 75-minutes. All the other ingredients are considered delicate vegetables, but it's okay, you want the pressure cooker to cook them to the point of disintegrating. It's the oxtail that needs to stand out and be the star of the

dish. During the cooking time, you can prepare some rice, Italian pasta, polenta, gnocchi or whatever you want to serve with the ragu.

When the cooking cycle is complete. You can choose to let the machine drop down in pressure on its own naturally, or you can exhaust all the pressure from the valve on top. The oxtails themselves will release a lot of liquid while cooking. So ladle out about half of the liquid and discard. Be careful not to remove any of the cooked vegetables if you can. Take out the oxtails individually as well and set aside.

Now we're going to reduce the liquid to thicken it. You can leave the lid open at this time. Season the sauce with salt and pepper. To make it a little thicker, you can add some flour. Reducing the sauce down will take a few minutes depending on how much liquid is in the pot. Once the sauce has thickened to preference, serve the ragu over pasta, polenta, gnocci or by itself and enjoy.

SOUPS/STEW:

ITALIAN CHICKEN NOODLE SOUP

SERVES 4

INGREDIENTS:

1 Whole Chicken (You can quarter it or leave it whole; or go the easy route and just use 6 chicken breasts)

3-5 Italian Sausage (Mild or Spicy)

1 Medium Yellow Onion (Chopped)

1 Cup Celery (Chopped)

2 Jalapenos (Chopped)

1 Cup Green Bell Pepper (Chopped)

3 Tbsp Fresh Oregano (Roughly Chopped)

1 Cup Canned Tomatoes

1/2 Cup Heavy Cream

3-4 Cups Low Sodium Chicken Broth

3-4 Cups Water

3 Cups Pasta Noodles (Macaroni, shells, ditalini, rigatoni, etc. It doesn't matter.)

In a skillet over medium heat, add a couple of tablespoons of olive oil. Add in the freshly chopped oregano. This will open up the fragrant herb and get all its flavors flowing. Cook the oregano for about 2 minutes. When that is done, remove all the cooked oregano into a small dish and set aside for later.

Now comes a quick sautéing of the vegetables. In the skillet, add the chopped onions, bell pepper, celery and jalapenos. Add a little more olive oil if needed and brown all the veggies for a couple of minutes. When that is done, remove all the veggies to another small dish and set aside for later.

Do the same again with the Italian Sausage. Remove the sausage from its

casing. Separate and brown the sausage just for a few minutes. You don't have to completely cook it all the way through. Again, set aside for later.

Add the whole chicken into the cooking pot. Pour in all the Chicken Broth and water so the majority of the chicken is covered. Add in all the chopped onions, celery, jalapenos and bell peppers. Shut the lid and turn it to lock it into position. Adjust the valve to Airtight. If you're cooking the chicken in quartered pieces, then you can just use the MEAT & CHICKEN pre-programmed button. If you're cooking the chicken whole, then, following the instructions for "How to use the Pressure Cook Time button" on page 10 of this manual, program the pressure cooker for 20-minutes. The machine will begin its heating process and slowly build up pressure. When the pressure has built up, the heating element will shut off and the letter "P" will appear on the LED screen. This is when the machine is using "Pressure" to cook the food. (If you're using just chicken breasts, cook for only 10-15 minutes or just press the MEAT & CHICKEN button.)

When the chicken is done, the pressure cooker will beep and automatically go to Keep Warm. Release all the pressure by setting the valve knob on top to Exhaust. When all the pressure has released, the float valve will drop and the lid can now be turned to unlock it and open. Remove all the chicken to a large platter. Remove and discard any gunk that's floating around in the liquid.

Let the chicken cool slightly then when it's cool enough to touch, shred it with a couple of forks into little bite size pieces. Remove any bones, skin or cartilage. Take all the shredded chicken and mix it with the cooked oregano from earlier. Give it a good toss and let it sit for a few minutes. Chop up the canned tomatoes coarsely and add it into the stock liquid that's still in the pressure cooker pot. Season with salt and pepper if desired.

Add in the desired pasta as well and the semi-cooked Italian sausage. Now put the shredded chicken and oregano mixture back into the pot with everything. Add the heavy cream and give it a quick stir. Shut the lid and lock it. Program the cook time for 5-minutes only. The pasta will cook fast.

When it's done, release all the pressure to avoid over cooking the pasta noodles. Open the lid and give everything a good stir. Season it with salt and pepper and let it sit for a few minutes. Garnish with some chopped fresh basil and parmesan cheese and serve.

ITALIAN POTATO, RICE, & SPINACH SOUP

SERVES 6

Ingredients

1/4 cup olive oil	2 tablespoons fresh lemon juice
6 leeks, white part only, sliced	3 tablespoons tomato paste
3 garlic cloves, crushed	1 tablespoon light brown sugar
2 carrots	10 ounces fresh spinach, rinsed, cut in large pieces
1/2 cup Arborio rice	1/4 cup parmesan cheese, grated
3 potatoes, cut in large chunks	1/4 cup fontinella cheese, grated
5 cups chicken stock	2 teaspoons dried basil
1/2 cup parsley, chopped	1/4 teaspoon pepper
1/2 cup celery, chopped	
1 bay leaf	
1 teaspoon salt	

Directions

- In a skillet over medium heat, heat oil. Add leeks, garlic, and carrots and sauté in hot oil for 2 minutes then remove from heat.
 - In cooking pot, add rice and potatoes. Stir well.
 - Add broth, parsley, celery, bay leaf, salt, pepper, basil, lemon juice, tomato paste and brown sugar. Stir well.
 - Close and lock the pressure cooker lid. Adjust the pressure valve on top to Airtight and press the SOUP & STEW function switch.
 - Cooking should be approximately 15-20 minutes.
 - When the pressure cooker has finished the cooking cycle, release all the pressure by carefully setting the valve to Exhaust on the top of the lid. Once all the pressure has released, the lid can be turned and unlocked.
 - Lift lid. Ladle the soup into large serving bowl or individual bowls
 - Combine the cheeses and sprinkle over soup. Serve with hunks of Italian bread.
-

SOUTH OF THE BORDER SPICY CHILI

SERVES 6

Chili is a nutritionally sound and complete meal. You can make it more or less fiery by adjusting the amount of chili powder used.

Ingredients

2 tablespoons olive oil	1 bay leaf
2 medium onions, chopped	2 teaspoons celery seed
3 garlic cloves, minced	Salt to taste
1 1/2 lb ground beef	1 tablespoon flour
2 teaspoons ground cumin	1 1/2 cups crushed tomato
2 tablespoons chili powder, or to taste	1 cup beef stock
1 1/2 teaspoons oregano	1 1/2 cups cooked pinto or red kidney beans

Garnishes

Grated cheddar or Monterey Jack cheese
Finely chopped onion
Shredded lettuce

Directions:

- In a skillet over medium heat, heat the oil and sauté the onion and garlic until the onion is wilted.
 - Add the beef and cook until it is browned. Mix the cumin, chili powder, oregano, bay leaf, celery seed, salt and flour. Stir in the crushed tomato and beef stock. Remove from heat.
 - In the cooking pot, add the beans.
 - Close and lock the pressure cooker lid. Adjust the pressure valve on top to Airtight and press the BEANS function switch.
 - When the pressure cooker has finished the cooking cycle, release all the pressure by carefully setting the valve to Exhaust on the top of the lid. Once all the pressure has released, the lid can be turned and unlocked.
 - Serve chili in bowls, passing the garnishes separately.
-

TORTILLA SOUP

SERVES 8-10

Ingredients

1/3 cup vegetable oil
2 onions, diced
4 cloves garlic, peeled
1 can tomatoes, drained
3 quarts chicken broth

2 Cups Cooked Shredded Chicken
Tortilla chips
cilantro, chopped
1 lb grated cheese
lime wedges (optional)

Directions:

- In a skillet over medium heat, sauté onions and garlic in the oil until they are deep golden brown and transparent.
 - Remove from skillet and purée with tomatoes in blender or food processor until smooth.
 - Return to pressure cooker cooking pot and add broth.
 - Close and lock the pressure cooker lid. Adjust the pressure valve on top to Airtight and press the SOUP & STEW function switch.
 - When the pressure cooker has finished the cooking cycle, release all the pressure by carefully setting the valve to Exhaust on the top of the lid. Once all the pressure has released, the lid can be turned and unlocked.
 - Add cilantro and salt to taste. Place cheese and tortilla chips in individual soup bowls and pour hot soup on top. Serve with lime wedges, if desired.
-

SAUSAGE AND LENTILS SOUP

SERVES 4

INGREDIENTS:

3-4 Cups Dried Lentils

1-2 Cups Chopped Sausage (Whatever kind of sausage to your liking, it doesn't matter.)

2 Cups Crushed Roasted Tomatoes

1 Cup Mirepoix (Which is just a fancy word for chopped mixture of celery, carrots and onions.)

4 Garlic, minced

2 Bay Leaves

2 Tbsp Beef Bullion (Or 2 Cups Beef Broth)

6 Cups Fresh Water (Less or more depending on the size of your pressure cooker.)

Salt & Pepper to taste

In a medium pan with medium heat, sauté the mirepoix and garlic until they are fragrant.

Once that is done, remove from heat and add to the cooking pot in your pressure cooker. Add all the remaining ingredients into the cooking pot also. Shut the lid and lock it properly into position. Adjust the Pressure Valve to "Airtight". Following the instructions for "How to use the Pressure Cook Time button" on page 10 of this manual, program the pressure cooker for 15-minutes.

Let the pressure cooker do its thing. The longer you cook the lentils, the more they break down.

When the cook time is complete and it's ready to release the pressure, make sure you're careful. Since it's a big pot of soup, there may be some spitting at the pressure valve when you turn it to exhaust. Sometimes a folded up dish rag or towel over the valve a bit will help.

When it is safe to open the lid, give the soup a good stir. It may appear a bit watery but depending on if you want to keep it more on the brothy side or you want to thicken it up a bit, you can thicken it by mixing a bit of the broth liquid with flour until it becomes a thick roux and dump the roux back into the soup and stir it up a bit. Season with salt and pepper to your preference. Serve with a dollop of sour cream or plain greek yogurt.

KIELBASA, BUTTERNUT SQUASH & KALE SOUP

SERVES 4

INGREDIENTS:

1 Package Kielbasa Sausage (Chopped into half-moon size)	4 Cups Chicken Broth
2 Cups Chopped Butternut Squash	2 Sprigs of Fresh Rosemary
1 Onion, Chopped	2 Cups Fresh Kale
4 Cloves Garlic, Minced	Water
1 Shot Glass Sherry, Cooking Wine or White Wine	
1 Cup Wild Rice (I ran out, so I just used brown rice)	

In a skillet over medium heat, add a bit of olive oil and place the first 4 ingredients in and sauté for about 4 minutes. Pour in the shot glass of cooking wine or sherry and sauté for another 2-3 minutes then remove from heat.

In the cooking pot, add in the wild rice and the chicken broth. Depending on how much soup you want, you can fill up the rest of the pot with water and add in the sprigs of fresh Rosemary and mixture from the skillet. **Don't put the Kale in with the soup yet until afterwards.**

Close and lock the pressure cooker lid. Set the Pressure Valve on the top to "Airtight" and following the instructions for "How to use the Pressure Cook Time button" on page 10 of this manual, program the pressure cooker for 10-minutes.

Note: If you are making a really large, almost full pot, the pressure cooker will take quite a while to heat up everything inside and come to pressure, about 20 to 30-minutes to build up pressure. Once the pressure has been reached and the float valve has sealed, the letter P will appear on the LED screen and the 10-minutes will begin to count down. Once the 10-minutes have reached 0, the cooker will automatically beep and go to keep warm.

Using a dish rag, carefully release the pressure by turning the Pressure Valve to "Exhaust". Once the pressure has been completely released, the float valve will drop which will release the locking mechanism on the lid. Now you can turn the lid to unlock it. Give everything a good stir. When the soup is ready to serve, you can add the kale to it and let the heat of the soup cook it just slightly. It will take less than a minute. Add salt and pepper to taste as you serve and eat.

JEDI SPLIT PEA & HAM-HOCK SOUP

INGREDIENTS:

2 Cups of Dried Split Peas
1-2 Small-Medium Ham Hock
1/2 Cup Chopped Yellow Onion
1/2 Cup Chopped Celery
3 Cloves of Finely Chopped Garlic
1 Cup Chopped Potatoes
1 Cup Chopped Carrots
1 Cup Chopped Ham or Smoked Sausage
4-6 Cups of Water or Chicken Stock

SPECIAL EQUIPMENT: Immersible Hand Blender

In a skillet over medium heat, add a bit of olive oil and sauté the onions, celery and garlic for a few minutes. Remove from heat.

Add the Split Peas to the vegetable mixture and add to the cooking pot. Take the piece of Ham Hock and use a sharp knife to cut a few slits into the chunk, but don't slice it all the way through. Add it to the mixture in the pot. Pour water into the pot so the water overlaps the mixture of Split Peas by 2 inches. You can choose to use chicken stock if you like but I used water to cut down on the sodium. You can do a mixture of water and stock as well.

Shut the lid and lock it. Adjust the valve on top to Airtight. Following the instructions for "How to use the Pressure Cook Time button" on page 10 of this manual, program the pressure cooker for 15-minutes.

When the pressure has built and the Float Valve rises, the machine will seal completely.

When it's finished, it will beep about three times and go to Keep Warm. Manually release the pressure by adjusting the pressure valve on top to Exhaust. Use a dish towel because the pressure may be hot and may sputter a bit. Once all the pressure has released, and the Float Valve has dropped, turn the lid to unlock it and lift it open.

The Split Peas will have pretty much disintegrated. Using a pair of tongs, remove the Ham Hock from the soup and set it aside. You'll need to put it back in again later. But for now, you just need it out of the way.

(This step is optional). Use an Immersible Hand Blender and put it in the soup mixture. Give it a few pulses to blend the soup into a smooth creamy texture. Now add the chopped carrots, potatoes and ham to the soup. Add some salt and pepper as well if you wish.

Replace the Ham Hock back in and shut the lid again. (Don't let the soup sit idle for too long because it will thicken as it sits and keeps warm. If it becomes too thick, add water or chicken stock.)

Program the pressure cooker to cook for another 5-minutes.

If the soup mixture is too thick, the machine might have a hard time building up pressure because the thick mixture might be over-heating at the bottom

of the pot. If this happens, the machine will just beep fairly soon and put itself on Keep Warm. Don't worry, leave the machine alone. It would have built up enough pressure in that time so just let it sit and drop down in pressure automatically. The carrots and potatoes are cut up small enough that it should cook fairly quickly. If not, you can always open up the lid, thin the soup down a bit and restart it back up.

When the soup is finished, serve while it's hot with some butter toast or croutons.

ITALIAN SAUSAGE THREE BEAN CHILI

SERVES 4

INGREDIENTS:

2 Packages Spicy Italian Sausage	1 Tbsp. Dried Oregano
(Or more, if you like it meaty)	1 Cups Pinto Beans
(Dry Beans)	1 Cups Kidney Beans
1 Whole Onion (Finely Chopped)	1 Cups Black Beans (Dry Beans)
4 Stalks of Celery (Finely Chopped)	1 Bottle/Can of Beer
1 Cup Corn (Fresh or Frozen)	2-4 Cups Chicken Stock
4 Serrano Chilies (Finely Chopped)	1 Can of Whole Tomatoes
1 Tbsp. Dried Basil	1 Can Tomato Sauce

(*you can also use a packet of Chili Seasonings.)

GARNISHES:

Sour Cream or Plain Greek Yogurt, Shredded Parmesan Cheese, Chopped Fresh Basil

In a skillet over medium heat, add a bit of olive oil and add the Onions, Celery, Chilies, Corn and Garlic and sauté for about 3-5 minutes.

While that is going, start separating the sausage and crumble them up into chunky pieces into the cooking pot with the other vegetable ingredients. Add the dried basil and oregano and any salt and pepper. Add the skillet mixture to the cooking pot and stir.

Now add to the pot the three types of beans. Give it another mix. Add the liquid ingredients now. You want to make sure the beans and everything else is fully submerged in liquid. Enough liquid that it overlaps the bean mixture by about 1-inch.

Shut the lid, and turn to lock it securely. Set the Pressure Valve to "Airtight" and following the instructions for "How to use the Pressure Cook Time

button” on page 10 of this manual, program the pressure cooker for 75- minutes. It’ll take about 5-7 minutes for the machine to build up pressure. Once pressure has been reached, the letter P will appear on the screen and the cook time will begin to count down.

Once the cooking is finished, it will beep and automatically go to keep warm. At this point, you can manually release the pressure by or allow it to Natural Release. Once the float valve has dropped and the lid is safe to open, unlock and lift the lid up. Give the chili a good stir! If it seems too dry or thick, add some chicken stock to it. Add salt and pepper to taste. And if you like more of a kick, some cayenne pepper too.

Serve hot with a sprinkle of shredded Parmesan cheese, a dollop of sour cream and some freshly chopped basil. **Note:** You can substitute dry beans for canned beans if you like. It would cut the cook time down substantially to about 15-20 minutes. You may also soak the dry beans overnight and then remove the bean husks before cooking.

FISHERMAN'S SEAFOOD CHOWDER

SERVES 4

THE SOUP BASE INGREDIENTS:

A Mild Roux Mix

- 1 Tbsp Flour
- 1 Tbsp Butter
- 1 Cup White Wine

The Stock & Other Ingredients

- 2 Cups Water
- 1 Cup Chicken Stock
- 1 Whole Onion (Chopped)
- 2 Whole Tomatoes (Chopped)
- 1/2 Cup Corn (Optional – I added these last minute so I didn't take a photo)
- 1/2 Cup Celery (Optional – I didn't add any cause my husband doesn't like them much)
- 4 Cloves of Garlic (Chopped – Not pictured, I forgot about it.)
- 1 Can Tomato Sauce
- 3 Bay Leaves
- 1/2 Tsp Saffron Strands

To make a roux, in a medium saucepan over medium heat, melt the butter and then add the flour to the butter and mix with a wooden spoon. Start diluting the roux with the white wine little by little.

To the roux mix, add the chopped onions, garlic and chopped tomatoes, plus the celery. Cook the mixture for just a couple of minutes and then remove from heat. The mixture should be thick and creamy. Season with salt and pepper.

In the cooking pot, transfer the mix and add all the water, tomato sauce and chicken stock. Add the bay leaves and saffron. Give everything a good mix. The soup base should be pretty watery with a slight hint of thickness. If it's still too thick, add more water or stock or white wine.

SEAFOOD INGREDIENTS:

- 1-2 Cups Seafood Mix (Calamari Rings, Scallops, Bay Shrimps, etc.)
- 1-2 Cups Whole Clams
- 1-2 Cups Whole Shrimp (Shells removed)
- 1-2 Cups Whole Mussels (The ones in my photo were the only ones I could find at my market)
- 1-2 Cups Langostino Tails
- 1-2 Cups Chopped Salmon (Or any other fish is fine)

Now it's time to add all the wonderful seafood to the soup base mix. I listed the ingredients as 1-2 cups for everything because some people like a bit more of something and a bit less of something else. Plus, it's also so you don't over-fill the cooking pot. You always want to leave at least about 2-inches from the top rim to prevent over-flowing. (If you like, you can remove the shells so there is more room.)

Once all the seafood has been added, give everything another good stir. Then shut the lid and turn it to lock it into position. Adjust the Pressure Valve to "Airtight". Following the instructions for "How to use the Pressure Cook Time button" on page 10 of this manual, program the pressure cooker for 10-minutes.

When the pressure cooker is finished with its cooking cycle, it will beep and go to keep warm automatically and start dropping the pressure down by itself. This recipe, you can choose to release the pressure manually or let it drop down in pressure by itself, it doesn't make a difference. But always check that "Pressure Float Valve" has dropped before attempting to turn the lid to unlock and open it.

Serve with slices of sourdough bread or crackers.

LEEK & ASPARAGUS RISOTTO

SERVES 4 -6

Ingredients

- 1 1/2 tablespoons olive oil
- 1 1/2 tablespoons butter
- 1 1/2 tablespoons water
- 2 garlic cloves, minced
- 1 1/2 cups leeks, sliced
- 1 1/2 cups Arborio rice
- 4 cups vegetable broth
- 1/4 lb asparagus, chopped into 1 inch segments
- 1 1/4 cups parmesan cheese, shredded

Directions

- In a skillet over medium heat, heat the olive oil and butter.
 - Add the garlic and leeks, sauté until soft then remove from heat.
 - In the cooking pot, add the skillet mixture and rice, stir thoroughly and then add broth.
 - Close and lock the pressure cooker lid. Adjust the pressure valve on top to Airtight and press the RICE function switch.
 - While risotto cooks, steam asparagus in water. Then sauté in olive oil. Season with salt and pepper.
 - When the pressure cooker has finished the cooking cycle, release all the pressure by carefully setting the valve to Exhaust on the top of the lid. Once all the pressure has released, the lid can be turned and unlocked. Add the sautéed asparagus, and Parmesan cheese.
 - Serve immediately.
-

DESSERTS:

ORANGE-FLAVORED CANDIED YAMS

SERVES 4

Ingredients

1 cup orange juice	1/2 cup brown sugar
2 large sweet potatoes (yams)	1 teaspoon grated orange zest
Salt, to taste	2 tablespoons butter

Directions:

- Pour the orange juice into the pressure cooker. Peel the sweet potatoes and cut them in half lengthwise. Arrange in a pressure cooker steamer basket (if available) and sprinkle with salt, brown sugar and orange zest. Dot with butter.
 - Lower the steamer basket into the pressure cooker.
 - Close and lock the pressure cooker lid. Adjust the pressure valve on top to Airtight and press the POTATOES & YAMS function switch.
 - When the pressure cooker has finished the cooking cycle, release all the pressure by carefully setting the valve to Exhaust on the top of the lid. Once all the pressure has released, the lid can be turned and unlocked. Lift out the sweet potatoes.
 - Boil down the sauce until thickened and pour over the sweet potatoes.
-

SPICED APPLE CRUNCH

SERVES 3

Ingredients

1 cup dry bread crumbs (unseasoned)	1 lemon (juice and rind)	3 apples, sliced
1/4 cup sugar		
1/2 teaspoon cinnamon	1/4 cup butter, melted	2 cups water

Directions:

- Butter a 15 cm (6") baking dish. Combine bread crumbs (or graham wafer crumbs), sugar, cinnamon, juice and lemon rind. Place alternate layers of apples and crumbs in baking dish. Pour melted butter over ingredients and cover baking dish firmly with aluminum foil.
- Place water, trivet, and then baking dish in pressure cooker.
- Close and lock the lid and following the instructions for "How to use the Pressure Cook Time button" on page 10 of this manual, program the pressure cooker for 20-minutes.
- When the pressure cooker has finished the cooking cycle, release all the pressure by carefully setting the valve to Exhaust on the top of the lid. Once all the pressure has released, the lid can be turned and unlocked
- If you wish to add more color and crunch, run the dish quickly under the broiler. Be sure to watch carefully to prevent burning.

OLD FASHIONED RICE PUDDING

SERVES 4

It's preferable to eat it the same day or the rice may become chewy.

Ingredients

1 tablespoon butter	1 egg
1/4 cup long grain rice	1/4 cup evaporated milk
2 cups milk	1/2 teaspoon vanilla
1 cup water	Cinnamon
1/3 sugar 1/2 teaspoon salt	

Directions:

- Melt the butter in a saucepan over medium heat and stir in the rice, coating it with the butter. Pour in the fresh milk and water, and then stir in the sugar and salt then remove from heat.
- Close and lock the lid and following the instructions for "How to use the Pressure Cook Time button" on page 10 of this manual, program the pressure cooker for 10-minutes.
- When the pressure cooker has finished the cooking cycle, release all the pressure by carefully setting the valve to Exhaust on the top of the lid. Once all the pressure has released, the lid can be turned and unlocked
- In a small bowl mix together the egg, evaporated milk and vanilla. Stir in a little of the hot liquid from the pressure cooker, then add the mixture to the pressure cooker.

- Cover again and set to cook for 5 more minutes.
 - When the pressure cooker has finished the cooking cycle, release all the pressure by carefully setting the valve to Exhaust on the top of the lid. Once all the pressure has released, the lid can be turned and unlocked. Cool 10 minutes, stirring occasionally.
 - Transfer to individual dessert bowls, continue cooling, then refrigerate. Serve sprinkled with cinnamon.
-

PEARS STEWED IN RED WINE

SERVES 4

A most elegant dessert when served with raspberry sauce. A fine ending to a special dinner.

Ingredients

2 cups water	4 firm pears, peeled but not cored, stems on
1/2 cup sugar	3/4 cup red wine
2 slices lemon	1 cup frozen raspberries
2 cinnamon sticks	4 tablespoons heavy cream
1/4 teaspoon mace	

Directions:

- In a saucepan over medium heat, combine the water, sugar, lemon, cinnamon sticks and mace. Simmer until the sugar is dissolved.
 - Place the pears into the pressure cooker cooking pot, trimming bottoms if necessary so they stand upright. Add the liquid from the saucepan.
 - Close and lock the lid and following the instructions for "How to use the Pressure Cook Time button" on page 10 of this manual, program the pressure cooker for 10-minutes
 - When the pressure cooker has finished the cooking cycle, release all the pressure by carefully setting the valve to Exhaust on the top of the lid. Once all the pressure has released, the lid can be turned and unlocked
 - Add the red wine.
 - Lock the lid in place again and program to cook for 10 more minutes. When the pressure cooker has finished the cooking cycle, release all the pressure by carefully setting the valve to Exhaust on the top of the lid. Once all the pressure has released, the lid can be turned and unlocked.
 - Carefully remove only the pears and transfer to a deep container.
 - Boil down the remaining sauce until it is syrup. Cool, then pour over the pears and keep at room temperature overnight.
 - To serve, defrost and purée the raspberries in a processor until smooth.
 - Spoon 4 tablespoons of the purée on four dessert dishes or shallow bowls. Place a pear upright in the center of each dish. Spoon some syrup over the pears.
 - Dribble 1 tablespoon of cream in a circle over the sauce. With the aid of a knife, swirl the cream into the sauce in an attractive design and serve.
-

CINNAMON APPLE FLAN WITH MAPLE SYRUP

SERVES 6

Ingredients

5 tablespoons maple syrup	1/4 teaspoon vanilla
1/4 teaspoon cinnamon	6 tablespoons sugar
2 apples, peeled and cut in 1/4" slices	2 1/2 cups milk
3 whole eggs	3 egg yolks

Directions:

- In a small saucepan, combine the maple syrup and the cinnamon. Add the apple slices and slowly simmer until the apples are tender.
- Divide the mixture into 6 greased oven-safe custard cups. In a large bowl, whisk eggs and egg yolks. Stir in vanilla, sugar and milk. Pour mixture slowly into the custard cups. Cover tightly with foil.
- Fill the pressure cooker cooking pot with 2 1/2 cups water. Place as many custard cups as will fit in the pressure cooker steamer basket (if available) and lower into the pressure cooker.
- Close and lock the lid and following the instructions for "How to use the Pressure Cook Time button" on page 10 of this manual, program the pressure cooker for 10-minutes.
- When the pressure cooker has finished the cooking cycle, release all the pressure by carefully setting the valve to Exhaust on the top of the lid. Once all the pressure has released, the lid can be turned and unlocked.
- Remove the lid, take out the basket, loosen the foil and cool the custard.
- Refrigerate. To serve, loosen the custard from the molds with a knife and invert onto dessert dishes.

COCONUT RICE PUDDING

SERVES 4

INGREDIENTS:

1 Cup Arborio Rice
3 Cups Coconut Milk (Unsweetened)
2 Cups Almond Milk (Unsweetened)
1 Cup Water
3 Cinnamon Sticks
1/2 Tsp Freshly Ground Cloves
1 Whole Vanilla Bean
3 Strips Orange Zest Strip
2 Cans Sweetened Condensed Milk

In a saucepan over medium heat, add all the liquid ingredients (except the condensed milk). Add the spices to the mixture. Leave the cinnamon sticks and orange zest strips whole. Using a knife, gently slice a long slit down the middle of the vanilla pod. Scrap all the vanilla bean out over the pot and throw it in and swish it around. Add in the whole vanilla pod also and bring the whole mixture to a light simmer. Remove from heat.

Add the rice and the liquid mixture to the cooking pot and give it a quick stir. Close the lid and turn it to lock it into place. Adjust the Pressure Valve on the top to Airtight. Following the instructions for “How to use the Pressure Cook Time button” on page 10 of this manual, program the pressure cooker for 15-minutes.

Once the cooking is complete, let it drop down in pressure on its own, do not manually release the valve to Exhaust. The pressure should drop on its own in about 10-minutes. Once all the pressure is gone, the Float Valve will drop, allowing you to unlock and open the lid. Press the CANCEL button to turn off the Keep Warm feature. Pull out the cinnamon sticks, orange zest and vanilla pod and discard.

Open up the two cans of Sweetened Condensed Milk and add it all to the rice pudding and stir. Allow it to cool slightly, then cover and place into the refrigerator to cool completely.

Serve warm or cold with a drizzle of honey if desired. Garnish with sliced strawberries, blueberries, orange zest or nutmeg.

PUMPKIN BOURBON CHEESECAKE

SERVES 6

INGREDIENTS:

Crust:

4-6 Macaroons

4 Sheets Graham Crackers

1-2 Tbsp Butter

Filling:

2 (8oz.) Cream Cheese

1/2 Cup White Sugar

1 Tsp Vanilla Bourbon Extract (I found mine at Trader Joes. As you can tell, I shop there a LOT!)

1 Tsp Whiskey or Bourbon

3/4 Cup Canned Pumpkin

2 Eggs

1/2 Tsp Cinnamon

1/4 Tsp Nutmeg

1/4 Tsp All Spice or Pumpkin Spice

Using a food processor, process all the Crust ingredients into a coarse and crumbly mixture. Grease the spring-form pan so the cheesecake doesn't stick. Take the crumbs and start forming and flattening them into the pan. Make sure to have the crust come up the sides of the pan as well, about an inch high.

For the filling, using a mixer or stand mixer, mix together the first three ingredients: cream cheese, sugar, vanilla extract and bourbon. Mix until smooth and then add the remaining ingredients until that is smooth as well. Use a spatula and pour the mixture into the spring-form pan over the crust.

Use a spoon to smooth it out as best as you can. Tap the pan a bit to get rid of any air bubbles.

Pour 2 cups of water into the main cooking pot of the pressure cooker. Set a trivet into the center of the pan and place the spring-form pan onto the trivet. You do NOT want the water touching the pan, so that's what the trivet is doing, lifting it up above the water line.

Shut the lid and turn to lock it into position. Adjust the Pressure Valve to "Airtight". Following the instructions for "How to use the Pressure Cook Time button" on page 10 of this manual, program the pressure cooker for 15-minutes. The cook time will go by pretty fast, when it beeps and goes to keep warm automatically, allow the unit to drop down in pressure by itself.

During this time, you can whip up some garnishes. You can use Whip Cream, chopped up nuts or pumpkin butter!!! This stuff is yummy! Put a few tablespoons of it into a little bowl and microwave it for about 20 seconds. Add a dash of whiskey to it if you want it runnier. Give it a good whisk. Once the pressure cooker has completely dropped down in pressure, you can open the lid and remove the cheesecake carefully. It may look really wet and moist, but just let it rest for a few minutes and then pop it into the refrigerator for at least 3-4 hours to firm up.

Slice and garnish with the pumpkin butter, whipped cream and chopped nuts and serve immediately.

CANNING RECIPES

Recipes courtesy of www.allrecipes.com

DILL PICKLES

Ingredients

8lbs 3 to 4 in long pickling cucumbers
4 cups white vinegar
12 cups water
2/3 cup of pickling salt
16 garlic cloves, peeled and halved
8 sprigs fresh dill weed
8 heads fresh dill weed

Directions:

1. Wash cucumbers, and place in the sink with cold water and lots of ice cubes. Soak in ice water for at least 2 hours but no more than 8 hours. Refresh ice as required. Sterilize 8 (1 quart) canning jars and lids in boiling water for at least 10 minutes.
2. In a large pot over medium-high heat, combine the vinegar, water, and pickling salt. Bring the brine to a rapid boil.
3. In each jar, place 2 half-cloves of garlic, one head of dill, then enough cucumbers to fill the jar (about 1 pound). Then add 2 more garlic halves, and 1 sprig of dill. Fill jars with hot brine. Seal jars, making sure you have cleaned the jar's rims of any residue.
4. Follow the instructions for "How to use the Pressure Cooker for CANNING" on page 13 of this manual and process sealed jars in a boiling water bath. Process quart jars for 15 minutes.
5. When the unit has reached optimum pressure, it will begin to pressure-seal the mason jars. The programmed time will begin to count down until it reaches zero.
6. When time has expired, the pressure cooker will beep 3-times and automatically go to Keep Warm.
7. The Keep Warm indicator light will illuminate. This indicates the Pressure Cooker is Naturally Releasing the pressure. (See Notes & Tips #5)
8. Open lid once pressure has completely released.
9. Carefully remove jars using special canning utensils or tools. **CAUTION: Jars are hot!**
10. Set jars on a towel or cooling rack and allow to cool completely in a draft-free location.
11. Store pickles for a minimum of 8 weeks before eating. Refrigerate after opening. Pickles will keep for up to 2 years if stored in a cool dry place.

JALAPENO PEPPER JELLY

Ingredients

3 Green Bell Peppers, minced
2 4oz cans diced jalapeno peppers
1 ½ cups distilled white vinegar
6 ½ cups sugar

½ tsp cayenne pepper
1 fl oz of liquid pectin
4 or 5 drops green food coloring

Directions:

1. In a large, stainless steel saucepan, combine peppers, vinegar, sugar, and cayenne pepper. Cook over medium high heat. Stir frequently until mixture begins to boil.
2. Stir in pectin; boil 5 minutes longer, stirring constantly, and mix in food coloring. Skim off foam, and remove from heat.
3. Sterilize canning jars and lids in boiling water for at least 10 minutes.
4. Ladle into sterilized jars and follow the instructions for "How to use the Pressure Cooker for CANNING" on page 13 of this manual and process sealed jars for 5 minutes in a boiling water bath.
5. When the unit has reached optimum pressure, it will begin to pressure-seal the mason jars. The programmed time will begin to count down until it reaches zero.
6. When time has expired, the pressure cooker will beep 3-times and automatically go to Keep Warm.
7. The Keep Warm indicator light will illuminate. This indicates the Pressure Cooker is Naturally Releasing the pressure. (See Notes & Tips #5)
8. Open lid once pressure has completely released.
9. Carefully remove jars using special canning utensils or tools. **CAUTION: Jars are hot!**
10. Set jars on a towel or cooling rack and allow to cool completely in a draft-free location.

FIG PRESERVES

Ingredients

16 cups of fresh figs
1 Tbsp baking soda
12 cups boiling water
8 cups sugar
4 cups water
1 lemon, sliced

Directions:

1. In a large mixing bowl place figs and sprinkle with baking soda. Pour the boiling water over the figs and soak for 1 hour.
2. Drain figs and rinse thoroughly with cold water. In a large pot combine the sugar and the 4 cups of water; bring to a boil and cook for 10 minutes.
3. Add the figs and lemon slices to the syrup and cook over low heat for 1 hour, stirring occasionally.
4. Sterilize canning jars and lids in boiling water for at least 10 minutes.
5. Carefully spoon figs into hot, sterilized jars and spoon syrup over figs, leaving 1/2 inch of head space. Top jars with lids and screw bands on tightly.

6. Follow the instructions for "How to use the Pressure Cooker for CANNING" on page 13 of this manual and process sealed jars for 10 minutes in a boiling water bath.
 7. When the unit has reached optimum pressure, it will begin to pressure-seal the mason jars. The programmed time will begin to count down until it reaches zero.
 8. When time has expired, the pressure cooker will beep 3-times and automatically go to Keep Warm.
 9. The Keep Warm indicator light will illuminate. This indicates the Pressure Cooker is Naturally Releasing the pressure. (See Notes & Tips #5)
 10. Open lid once pressure has completely released.
 11. Carefully remove jars using special canning utensils or tools. **CAUTION: Jars are hot!**
 12. Set jars on a towel or cooling rack and allow to cool completely in a draft-free location.
-

FRESH GARDEN SALSA

Ingredients

- 7 cups of fresh tomatoes, peeled, cored, seeded and diced
- 6 green onions, sliced
- 2 or 3 jalapeno peppers, diced
- 4 cloves of garlic, minced
- ½ cup of vinegar
- 2 Tbsp lime juice
- 4 drops of hot pepper sauce
- 2 Tbsp fresh minced cilantro
- 2 tsp salt

Directions:

1. Sterilize canning jars and lids in boiling water for at least 10 minutes.
2. Combine all ingredients in a large saucepan.
3. Heat to a boil. Reduce heat and simmer 15 minutes.
4. Ladle hot salsa in to hot jars leaving 1/2 inch headspace. Remove air bubbles. Wipe rim. Center hot lid on jar. Apply band and adjust until fit is fingertip tight.
5. Following the instructions for "How to use the Pressure Cooker for CANNING" on page 13 of this manual, process filled jars for 15 minutes.
6. When the unit has reached optimum pressure, it will begin to pressure-seal the mason jars. The programmed time will begin to count down until it reaches zero.
7. When time has expired, the pressure cooker will beep 3-times and automatically go to Keep Warm.
8. The Keep Warm indicator light will illuminate. This indicates the Pressure Cooker is Naturally Releasing the pressure. (See Notes & Tips #5)
9. Open lid once pressure has completely released.
10. Carefully remove jars using special canning utensils or tools. **CAUTION: Jars are hot!**
11. Set jars on a towel or cooling rack and allow to cool completely in a

draft-free location.

12. Check lids for seal after 24 hours. Lid should not flex up and down when center is pressed.

HOMEMADE DRIED APRICOT JAM

Ingredients

- 4 ½ cups of dried apricots
- 4 ½ cups of boiling water
- 1 tsp vanilla extract
- 1 1.75oz package of powdered fruit pectin
- 7 cups sugar
- ¼ cup fresh lemon juice

Directions:

1. Soak apricots in boiling water in a bowl until hydrated, about 30 minutes. Blend apricots, remaining water, and vanilla extract in a food processor, working in batches, until blended but still slightly chunky.
2. Combine apricot mixture with pectin in a large pot over medium heat; cook until just boiling. Add sugar and lemon juice; boil until sugar has dissolved, 1 to 2 minutes.
3. Sterilize jars and lids in boiling water for at least 5 minutes. Pack the apricot jam into the hot, sterilized jars, filling the jars to within 1/4-inch of the top. Run a knife or a thin spatula around the insides of the jars after they have been filled to remove any air bubbles. Wipe the rims of the jars with a moist paper towel to remove any food residue. Top with lids, and screw on rings.
4. Place a rack or trivet in the bottom of the pressure cooker cooking pot and fill halfway with water. Carefully lower the jars into the pot using a holder. Leave a 2-inch space between the jars. Pour in more boiling water if necessary until the water level is at least 1 inch above the tops of the jars.
5. Follow the instructions for "How to use the Pressure Cooker for CANNING" on page 13 of this manual and process sealed jars for 10 minutes in a boiling water bath.
6. When the unit has reached optimum pressure, it will begin to pressure-seal the mason jars. The programmed time will begin to count down until it reaches zero.
7. When time has expired, the pressure cooker will beep 3-times and automatically go to Keep Warm.
8. The Keep Warm indicator light will illuminate. This indicates the Pressure Cooker is Naturally Releasing the pressure. (See Notes & Tips #5)
9. Open lid once pressure has completely released.
10. Carefully remove jars using special canning utensils or tools. **CAUTION: Jars are hot!**

Place onto a cloth-covered or wood surface, several inches apart, until cool, about 1 hour. Once cool, press the top of each lid with a finger, ensuring that the seal is tight (lid does not move up or down at all). Store in a cool, dark area.

LIMITED WARRANTY* ONE (1) YEAR
WARRANTY IS ONLY VALID WITH A DATED PROOF OF PURCHASE

1. Your small kitchen appliance is built with precision, inspected and tested before leaving our factory.
2. It is warranted, to the original purchaser to be free from any manufacturing defects under normal use and conditions for one (1) year, cord excluded. This Warranty applies only to the original purchaser of this product.
3. If you need to exchange the unit, please return it in its original carton, with a sales receipt, to the store where you purchased it. If you are past the stores allowed return policy period, please see the enclosed Warranty.
4. If you use your appliance for household use and according to instructions, it should give you years of satisfactory service.
5. During the one-year warranty period, a product with a defect will be either repaired or replaced with a new or reconditioned comparable model (at our option) when the product is returned to our Service Center. (See the "Returns" section below).
6. The repaired or replacement product will be in warranty for the remaining balance of the one-year warranty period and an additional one-month period.
7. **This limited warranty covers appliances purchased and used within the 50 contiguous states plus the District of Columbia and does NOT cover:**
 - Damages caused by unreasonable use, neglect, normal wear and tear, commercial use, improper assembly or installation of product.
 - Damages caused in shipping.
 - Damages caused by replacement or resetting of house fuses or circuit breakers.
 - Defects other than manufacturing defects.
 - Breakage caused by misuse, abuse, accident, alteration, lack of proper care and maintenance, or incorrect current or voltage.
 - Lost or missing parts of the product. Parts will need to be purchased separately.
 - Damages of parts that are not electrical; for example: cracked or broken plastic or glass.
 - Damage from service or repair by unauthorized personnel.
 - Extended warranties purchased via a separate company or reseller.
 - Consumer's remorse is not an acceptable reason to return a product to our Service Center.

*One Year Limited Warranty valid only in the **50 contiguous states plus the District of Columbia, excluding** Puerto Rico and the Virgin Islands.

This warranty is effective only if the product is purchased and operated in the USA; product usage which is in violation of the written instructions provided with the unit will void this warranty.

For international warranty, please contact the local distributor.

**Any instruction or policy included in this manual may be subject to change at any time.

MAXI-MATIC, USA

18401 E. Arenth Ave. City of Industry, CA 91748

Customer Service Dept: (626) 912-9877 Ext: 120/107 MON-FRI 8am-5pm PST

Website: www.maxi-matic.com email: info@maxi-matic.com

RETURN INSTRUCTIONS

RETURNS:

A. Any return of defective merchandise to the manufacturer must be processed accordingly by first contacting customer service (contact information shown below) to obtain an RA # (Return Authorization Number). We will not accept any returns of merchandise without an applicable RA #.

B. IMPORTANT RETURN INSTRUCTIONS. Your Warranty depends on your following these instructions if you are returning the unit to Maxi-Matic USA:

1. Carefully pack the item in its original carton or other suitable box to avoid damage in shipping.
2. Before packing your unit for return, be sure to enclose:
 - a) Your name, full address with zip code, daytime telephone number, and RA#,
 - b) A dated sales receipt or PROOF OF PURCHASE,
 - c) The model number of the unit and the problem you are having (Enclose in an envelope and tape directly to the unit before the box is sealed,) and
 - d) Any parts or accessories related to the problem.
3. Maxi-Matic USA recommends you ship the package U.P.S ground service for tracking purposes. We cannot assume responsibility for lost or damaged products returned to us during incoming shipment. For your protection, always carefully package the product for shipment and insure it with the carrier. C.O.D shipments cannot be accepted.

4. All return shipping charges must be prepaid by you.

5. Mark the outside of your package:

MAXI-MATIC USA
18401 E. ARENTH AVE.
CITY OF INDUSTRY, CA 91748

6. Once your return has been received by our warehouse, Maxi-Matic USA will repair or replace the product if it is defective in material or workmanship, subject to the conditions in paragraph B.

7. Maxi-Matic will pay the shipping charges to ship the repaired or replacement product back to you.