

Assembly Instructions

Item# L-GZ375PST

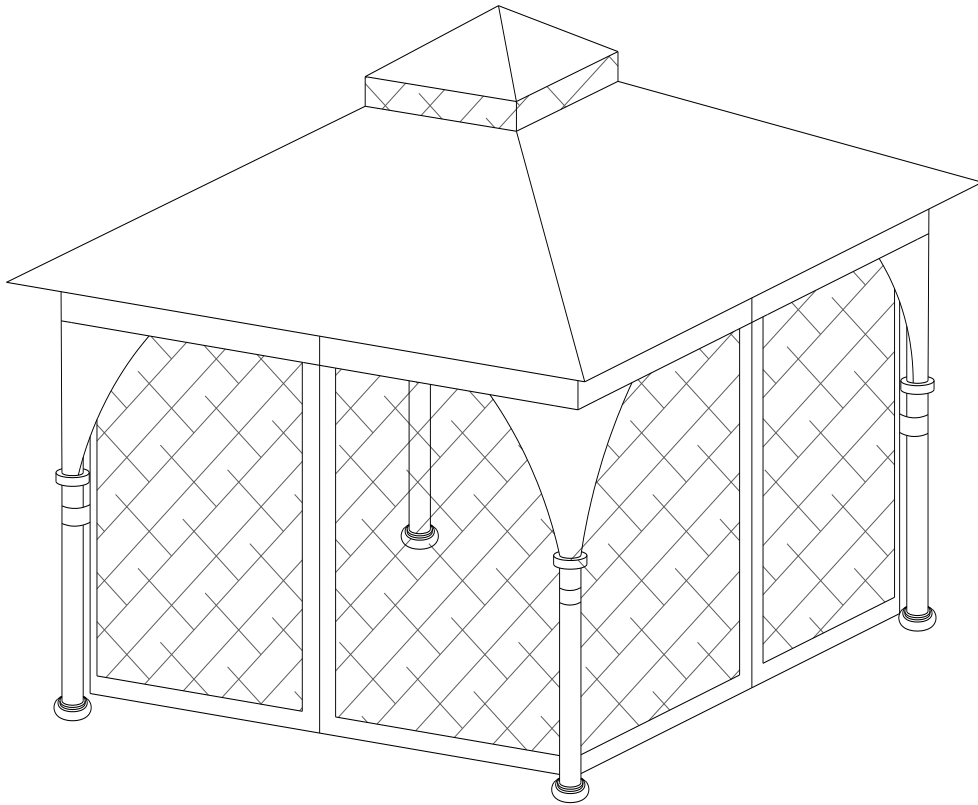

GAZEBO ASSEMBLY INSTRUCTIONS

Our clear, easy-to-follow, step-by-step instructions will guide you through the project from start to finish. The final product will be a quality piece that will give you years of enjoyment.

All you will need is a screwdriver, a hammer and two ladders of at least 8 feet (2.5 m) high (not included).

DO NOT assemble this item alone for your safety. Two people are necessary for smooth & safe installation.

Item identification: For ease of identification, all parts are labeled to correspond to the Step number in which the part is used.

Hardware Pack 1

8 pieces (AA) 1/4"-20*0.6 Bolt

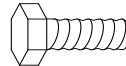

32 pieces (BB) 1/4"-20*1.18 Bolt

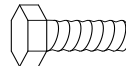

8 pieces (CC) 1/4"-20*1.4 Bolt

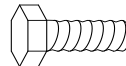

56 pieces (DD) 1/4"-20 Flat Washer



8 pieces (EE) 1/4"-20 Nut



1 pieces (FF) 1/4"-20 Wrench

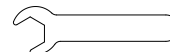



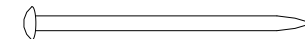







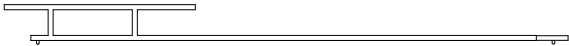

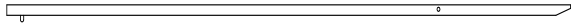
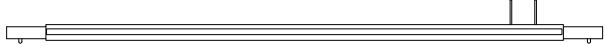
8 pieces (GG) 1/4"*10 Stake



32 pieces (HH) Mosquito Netting Hook

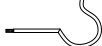

Parts List

Top connector	A	1	
Long angle beam	B	4	
Short angle beam	C	4	
Girder	D	4	
Horizontal beam 1	E	4	
Horizontal beam 2	F	4	
Connector	G	4	
Post	H	4	
Post foot	I	4	
Arc connector	J	4	
Hook	K	1	
Small canopy	L	1	
Big canopy	M	1	
Mosquito netting	N	1	

Step 1

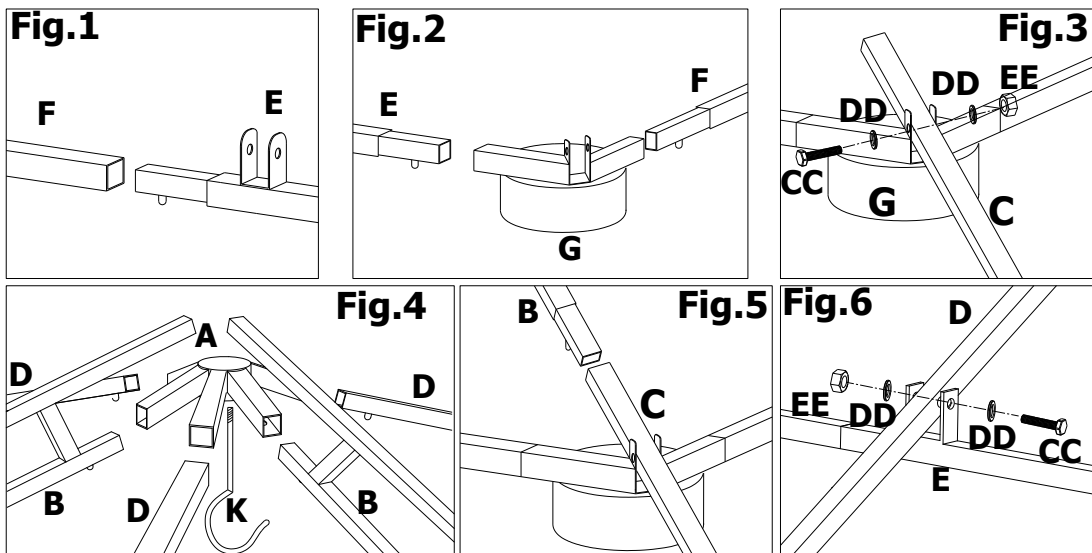
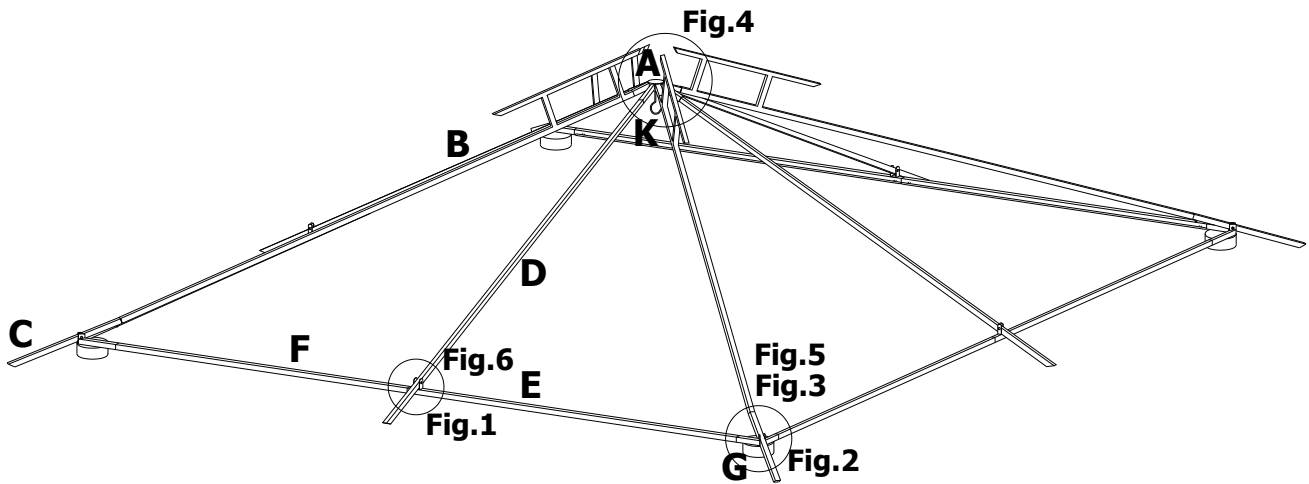

Step 1:

1. Insert one side of horizontal beam 1(E) into horizontal beam 2 (F) (Fig.1) Repeat on all sides.
2. Insert another side of horizontal beam 1(E) and horizontal beam 2 (F) into the hole of connector (G) (Fig.2). Repeat on all sides.
3. Connect short angle beam (C) with connector (G) and tighten with bolt (CC), bolt (DD), bolt (EE) (Fig.3)
4. Insert hook (K) into top connect (A) first, then insert long angle beam (B) and one side of girder (D) into top connector (A). Repeat on all sides. (Fig.4)
5. Insert one side of long angle beam (B) into short angle beam (C). (Fig.5)
6. Use bolt (CC), flat washer (DD) and nut (EE) to connect girder (D) and horizontal beam 1 (E). Repeat on all sides. Tighten all bolts. (Fig.6)

Step 2

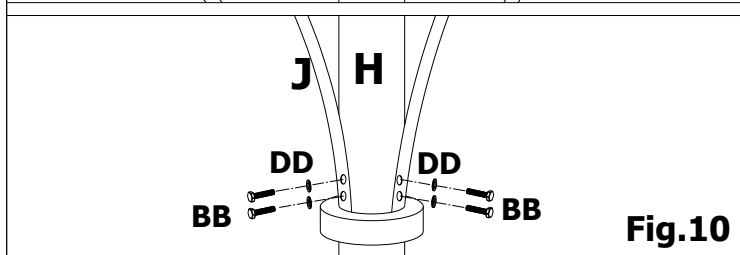
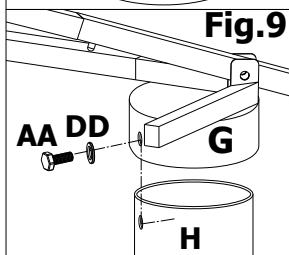
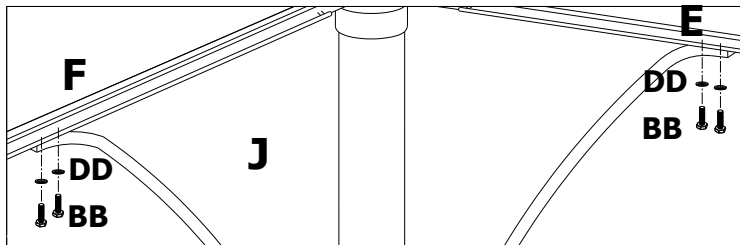
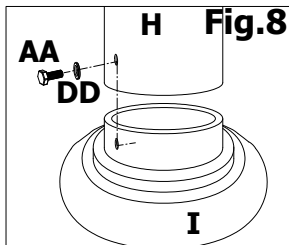
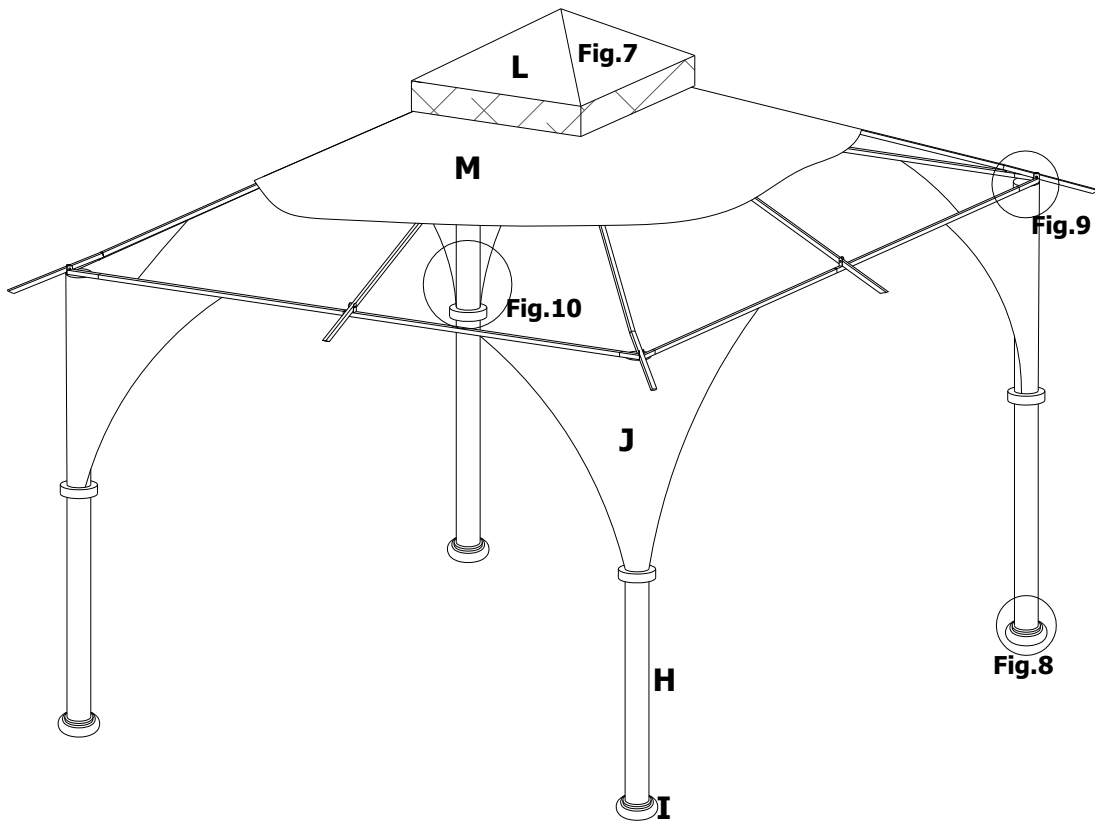

Step 2:

7. Finish covering small canopy (L), install big canopy (Q) on the structure but do not fully cover. (Fig.7)
8. Attach post foot (I) and post (H) and tighten them by using bolt (AA), flat washer (DD). Repeat on all posts.
9. Lift assembled roof (G) up, fix connector (G) and post (H) with bolt (AA), flat washer (DD). Repeat for all posts. (Fig9)
10. Connect one side of arc connector (J) with pole (H), and connect the other side with horizontal beam 1 (E) and horizontal beam 2 (F). (Fig.10)

Step 3

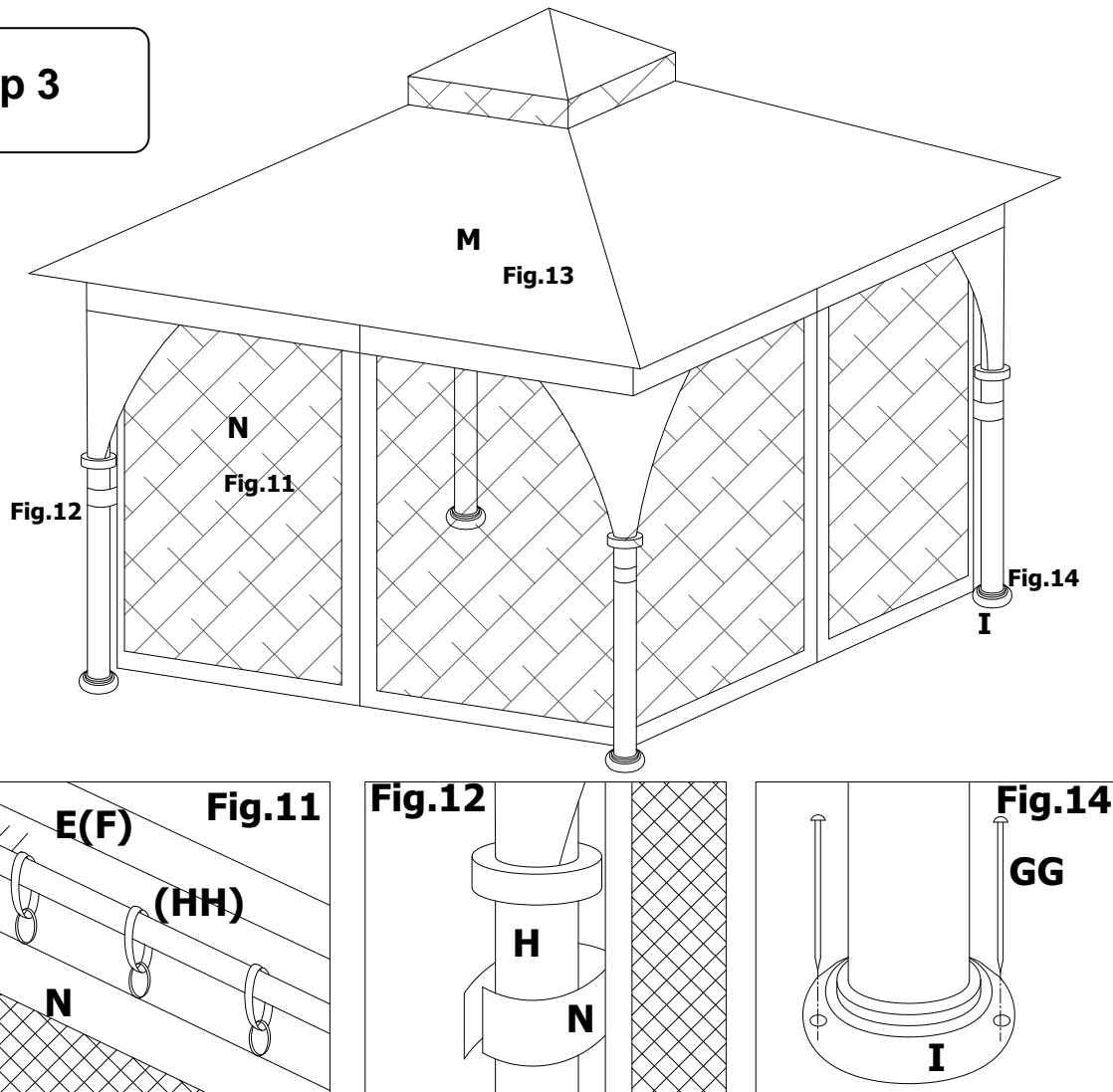

Step 3:

11. Use mosquito netting hooks (HH) to hang mosquito netting (N) onto horizontal beam 1 (E) and horizontal beam 2 (F). (Fig.11)
12. Make sure the velcro tie of the mosquito netting (N) is properly attached to the pole (H) (Fig.12)
13. Spread big canopy (M) over the entire structure, and slide into each corner.. (Fig.13)
14. Insert stakes (GG) in post foot (I) to secure gazebo to the ground. Repeat on all posts.
Your gazebo is now fully assembled.

USE:

1. This gazebo is not a permanent structure and should be disassembled & stored away after seasonal use.
2. Do not repack your sun shelter until the fabric is completely dry.
3. This sun shelter must be assembled by two adults or more.
4. This sun shelter must not be left erect in windy conditions.

NOTE: The gazebo's roof and structure are not guaranteed against extreme weather conditions (storms, high winds, etc.). If the gazebo is not dismantled for the winter, snow must be cleaned off regularly. Any damage caused by snow accumulation is not covered by the warranty.

Limited Warranty:

This limited warranty is extended to the original purchaser and applies to defects in materials and workmanship of your item provided the item is maintained with care and used only for personal, residential purposes.

The item is warranted to be free from defects in material or workmanship for a period of **six months**. We don't reimburse for transportation or delivery costs, or compensate the individual or any outside party for assembling or disassembling the product.

Exclusions:

Items used for commercial, contract, or other non-residential purposes, or items damaged due to acts of nature, vandalism, misuse, or improper assembly are not covered. Corrosion or rusting of hardware is not covered. Proof of purchase (dated register receipt) is required for warranty claims. Warranty is to the original purchaser and is non-transferable. Any replacement of warranted items will be in the original style and color, or a similar style and color if the original is unavailable or has been discontinued. As some states do not allow exclusions or limitations on an implied warranty, the above exclusions and limitations may not apply. This warranty gives you specific rights, and you may also have other rights, which vary from state to state.

Maintenance:

Our iron/steel components for garden accessories and patio items are coated with rust inhibiting paint that protects it from rusting. However, due to the nature of iron, surface oxidation (rusting) will occur once these protective coatings are scratched. This is a natural process and is not a defect! To minimize this condition, we recommend care when assembling & handling the product to prevent scratching the paint. Should any scratching or damage occur, we recommend immediate touch-up with rust inhibiting paint. Surface rust can also be easily removed with a very light application of common cooking oil. If surface oxidation (rusting) occurs and if no measure is taken to prevent this, the oxidation may start dripping on to deck or patio and cause damaging stains, which may be difficult to remove. This can be prevented if measure is taken to keep the product from oxidizing.

Important: Please do not return this product to the store. For technical assistance on assembly or replacement parts. Please call Sunjoy Industries at 1-866-578-6569 from 8:00 am EST to 8:00 pm PST or fax the replacement part form which is in the box to 1-740-283-3549 or Email customer.care@sunjoygroup.com for assistance.

Made in China