





Assembly Instructions

Dining Table

Hardware List		
A. Spanner		1 PC
B. Hex Nut		8 PCS
C. Spring Washer		8 PCS
D. Flat Washer		8 PCS

Part List	
E. Table Top	1 PC
F. Table Legs	4 PCS

Tips: Place all wooden parts on a clean and smooth surface such as rug or carpet to avoid the parts from being scratched. Check to ensure that all parts and hardware are available before you start to assemble.

Step 1: Attach Table Leg (F) to Table Top (E) using Flat Washer (D), Spring Washer (C) and Hex Nut (B). Tighten Hex Nut (B) with Spanner (A).

Step 2: Repeat Step 1 to assemble the other three legs (F).

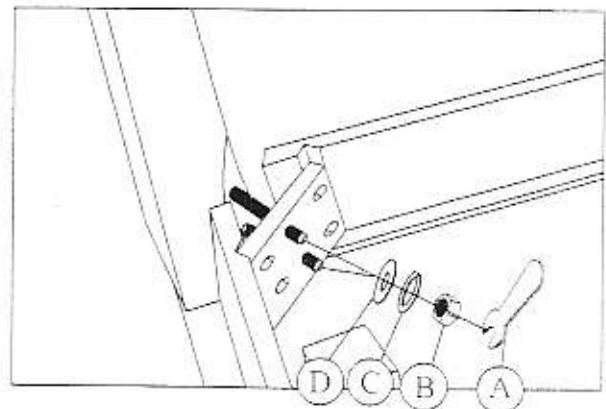
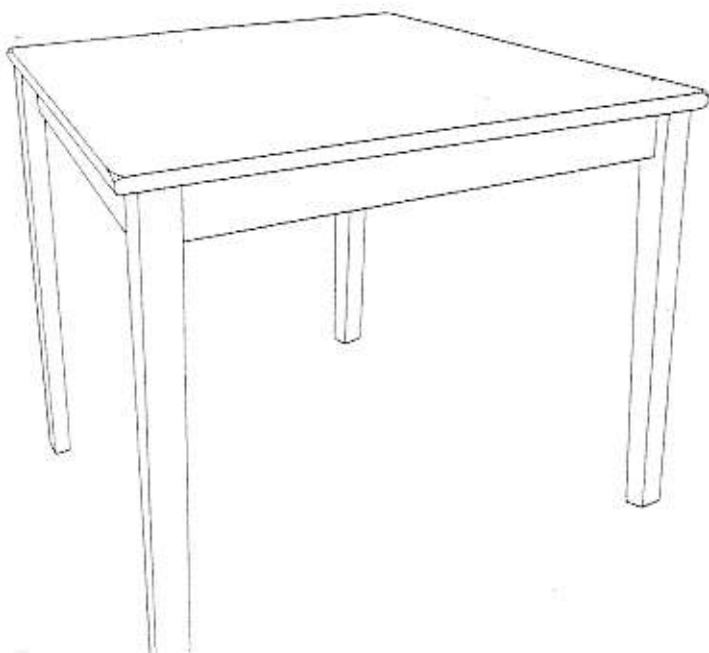

Assembly Instruction For Barstool

= Tighten all JCBC Screw (A) with Allen Key (B).



Place seat upside down smooth carpet surface. Line up legs of Leg Frame with screw holes on bottom of seat and attach with using JCBC Screw (A).



Insert cross bars into leg frame and secure with JCBC screw (A).

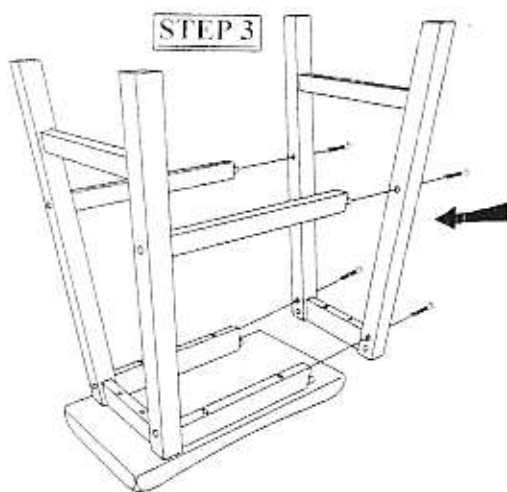

Line up of second leg frame with screw holes on bottom of seat and attach using JCBC screw (A). Do not tighten these screw all the way until you insert the cross bars when all holes are aligned. Tighten all remaining screw.



Insert wood bottom (C) into every screw hole in leg.

Hardware list

