

# MARVEL

## AIR HOCKEY TABLE



Warning

Adult Assembly Required

Asamblea de adultos de advertencia necesaria



MODEL # / No. de Modelo

**#390028**

Assembly and Instructions/Asamblea e Instrucciones

**Congratulations!**

We hope you will have many hours of enjoyable use with your new AHB AIR HOCKEY Table!

**PLEASE KEEP YOUR INSTRUCTIONS!**

- Your Model number is necessary should you need to contact us.
- Please read through this instruction book to familiarize yourself with all the parts and assembly steps.
- Refer to the Parts Identifier and verify that all parts have been included.

**¡Felicitaciones!**

¡Nosotros esperamos que este nueva mesa de fútbol AHB le proporcione muchas horas de diversión!

**¡POR FAVOR GUARDE ESTAS INSTRUCCIONES!**

- Su número de modelo es necesario en caso de que deba comunicarse con nosotros.
- Por favor leer este manual de instrucciones para familiarizarse con todas las piezas y los pasos a seguir en el montaje.
- Consultar la lista Identificación de las Piezas y asegúrese de que todas las piezas hayan sido incluidas.

**WARNING!**

This is not a child's toy. Adult supervision is required for children playing this game. Please read instructions carefully. Proper use of this set can avoid damage or injury.

**¡ADVERTENCIA!**

Esto no es un juguete de niños. La supervisión adulta es requerida para jugar este juego por los niños. Por favor leer las instrucciones con cuidado. El empleo apropiado de este juego puede evitar el daño o la herida.

**BEFORE ASSEMBLY:**

- Did you receive 1 box?
- Did you inspect your playfield/main table frame before assembly? It is not replaceable and must be returned to the original place of purchase if damaged.

**ANTES DE ASAMBLEAR:**

- ¿Recibió usted 1 caja?
- ¿Inspeccionó usted su campo de juego/marco de mesa antes de la asamblea? No es reemplazable y debe ser devuelto al lugar original de compra.

**TOOLS REQUIRED FOR ASSEMBLY:**

- Phillips and Slotted Head Screwdrivers / or Power Driver (not included)
- Allen Wrench (included)

**HERRAMIENTAS NECESARIAS PARA MONTAR:**

- Destornilladores Phillips y de cabeza ranurada / o destornillador eléctrico (no incluido)
- Llave hexagonal (incluida)

**ASSEMBLY INSTRUCTIONS:**

**We recommend that two adults work together to assemble this table.**









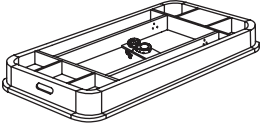

- The table will be assembled upside down This is a very heavy table and turning it right side up it will require at least two strong adults.
- We suggest that you use the bottom carton as a clean flat work area to protect the top of your foosball table while assembling.

**INSTRUCCIONES DE ENSAMBLE**

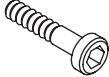
**Nosotros recomendamos que dos adultos trabajen juntos para ensamblar esta mesa.**

- La mesa debe ser ensamblada de cabeza. Esta es una mesa muy pesada y el voltearla va a requerir al menos dos personas adultas.
- Nosotros sugerimos que utilice el cartón de la base como un área plana de trabajo para proteger la superficie del fulbito de mano cuando es ensamblado.

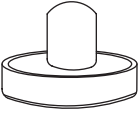
# Parts List

<p>#1</p>  <p>Main Cabinet 1Set</p>	<p>#2</p>  <p>Left Leg 2 Pieces</p>	<p>#3</p>  <p>Right Leg 2 Pieces</p>	<p>#4</p>  <p>Leg Connector 2 Pieces</p>
<p>#5</p>  <p>Leg panel 2 Pieces</p>	<p>#6</p>  <p>5/16"X1-1/2" Bolt 20 Pieces</p>	<p>#7</p>  <p>5/16"X19MM Washer 20 Pieces</p>	<p>#8</p>  <p>1/4"X3/4" Bolt 20 Pieces</p>
<p>#9</p>  <p>1/4"X16MM Washer 20 Pieces</p>	<p>#10</p>  <p>Pusher 4 Pieces</p>	<p>#11</p>  <p>Ø3" Puck 4 Pieces</p>	<p>#12</p>  <p>Allen Key 1 Piece</p>

## Step :1

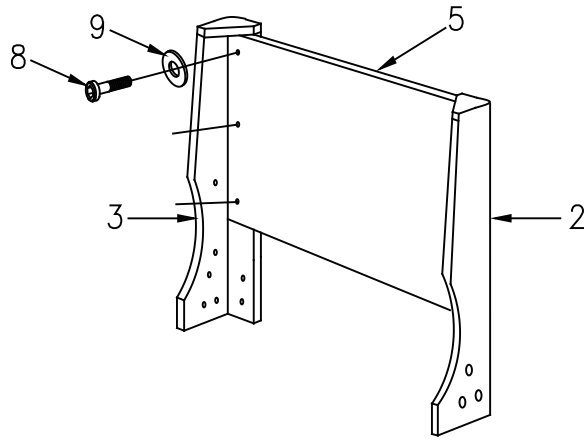

- Attach Leg panel (part #5) to Left and Right Legs (parts #2 and #3) using six 1/4 x 3/4" Bolts (#8) and six 1/4" Washers (#9). Finger tighten until all bolts are in place, then completely tighten.
- Repeat with remaining legs and panel.

## Step :2

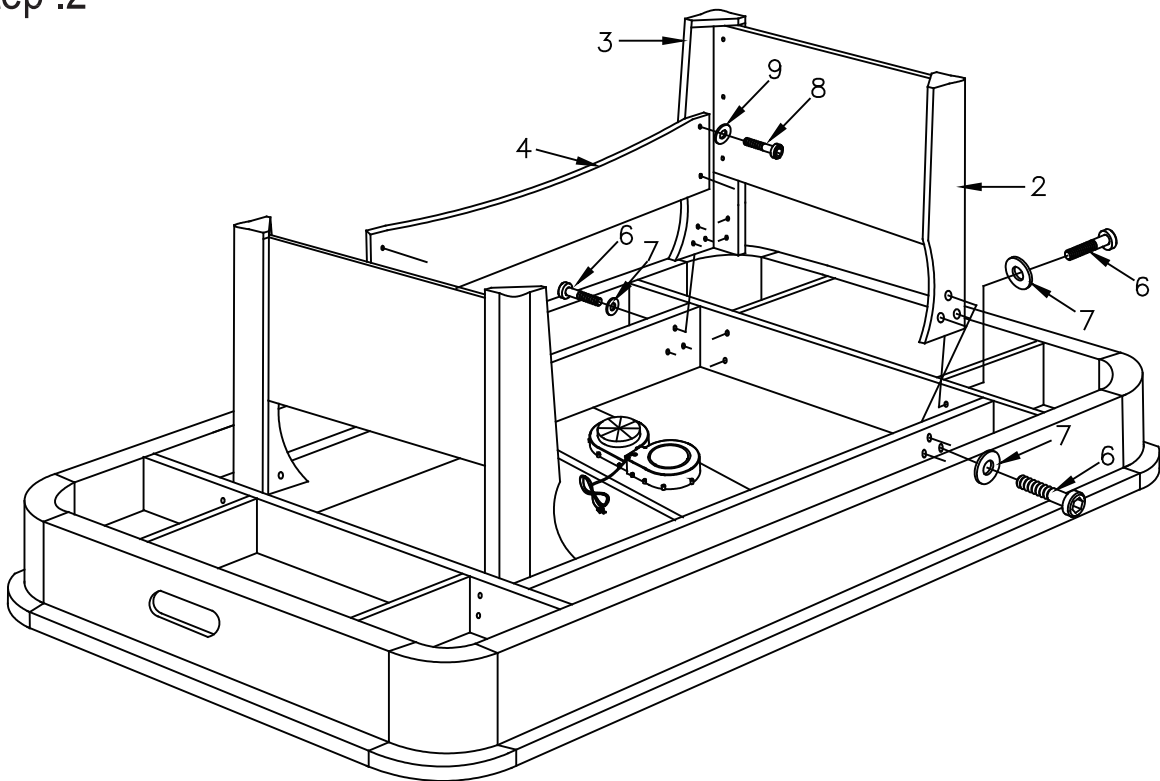

- Attach one leg/panel construction to Main Cabinet (#1) ,using 5/16"Bolts (#6) and 5/16" Washers (#7) ,Repeat For Second Leg.
- Attach Leg Connector (#4) to legs as shown,using four (4) 1/4 x 3/4" Bolts (#8) and 1/4" Washers (#9) . Finger tighten until all bolts are started , then completely tighten.
- Repeat for remaining leg connector.

### Step :3

- Using two strong adults, carefully turn the table right side up.
- Assembly is now complete, enjoy your new air hockey table!

