

Assembly Instruction

400MM

1200MM

960MM

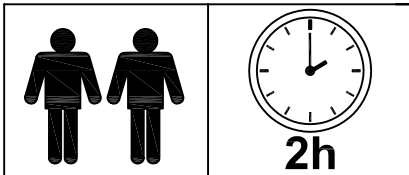
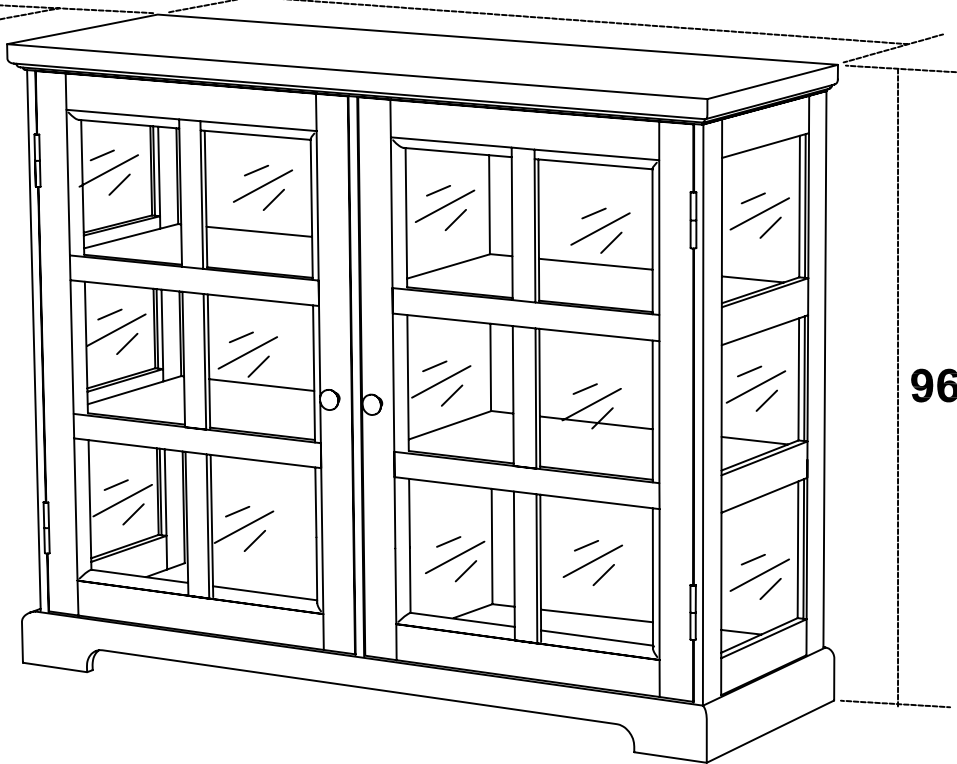

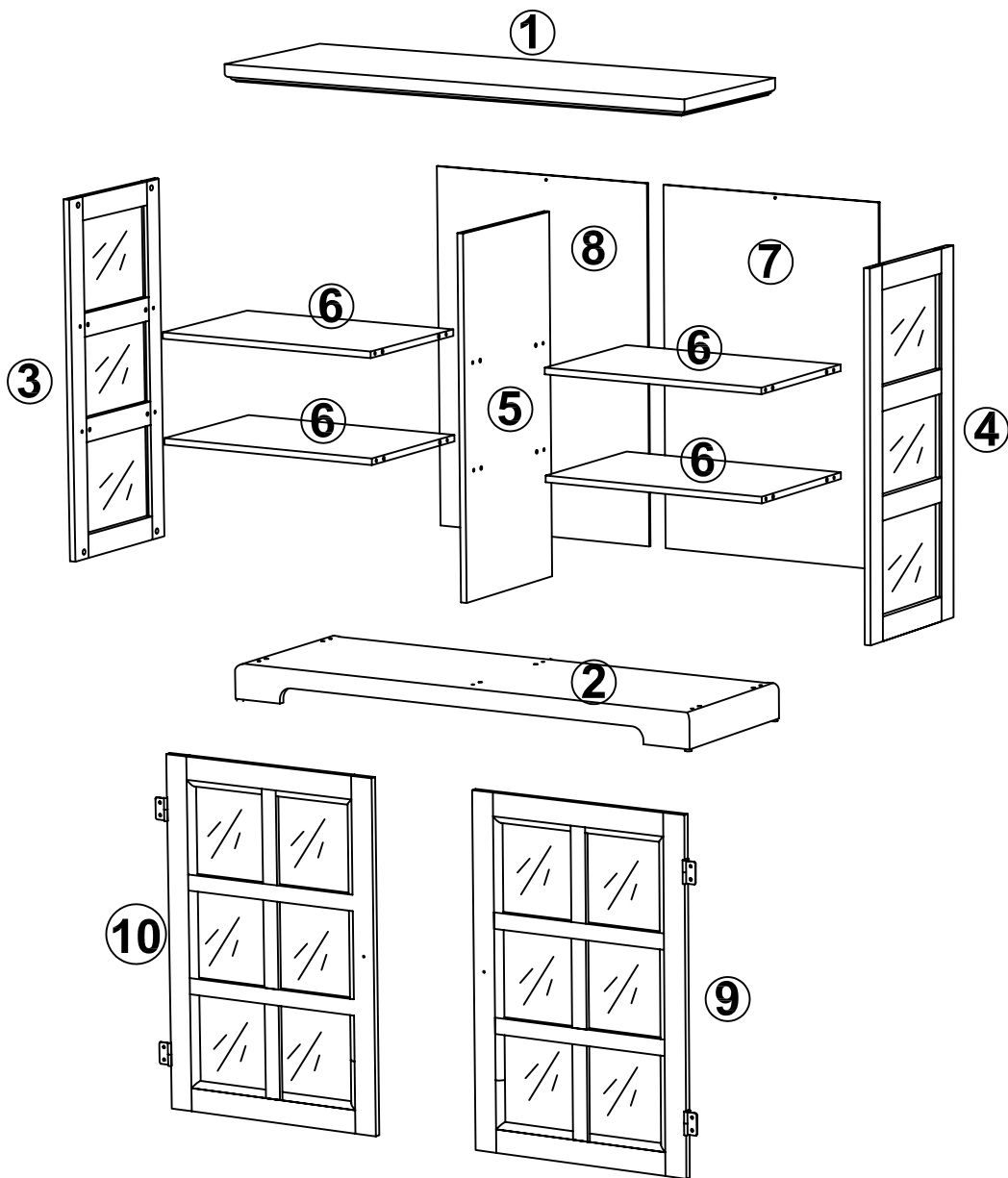

- | | | | |
|---------------|--|---------------|--|
| A X 20 | | G X 10 | |
| B X 28 | | H X 23 | |
| C X 20 | | I X 2 | |
| D X 4 | | J X 2 | |
| E X 4 | | K X 2 | |
| F X 4 | | M X 2 | |

2

F X 4 

G X 2 

J X 2 

K X 2 

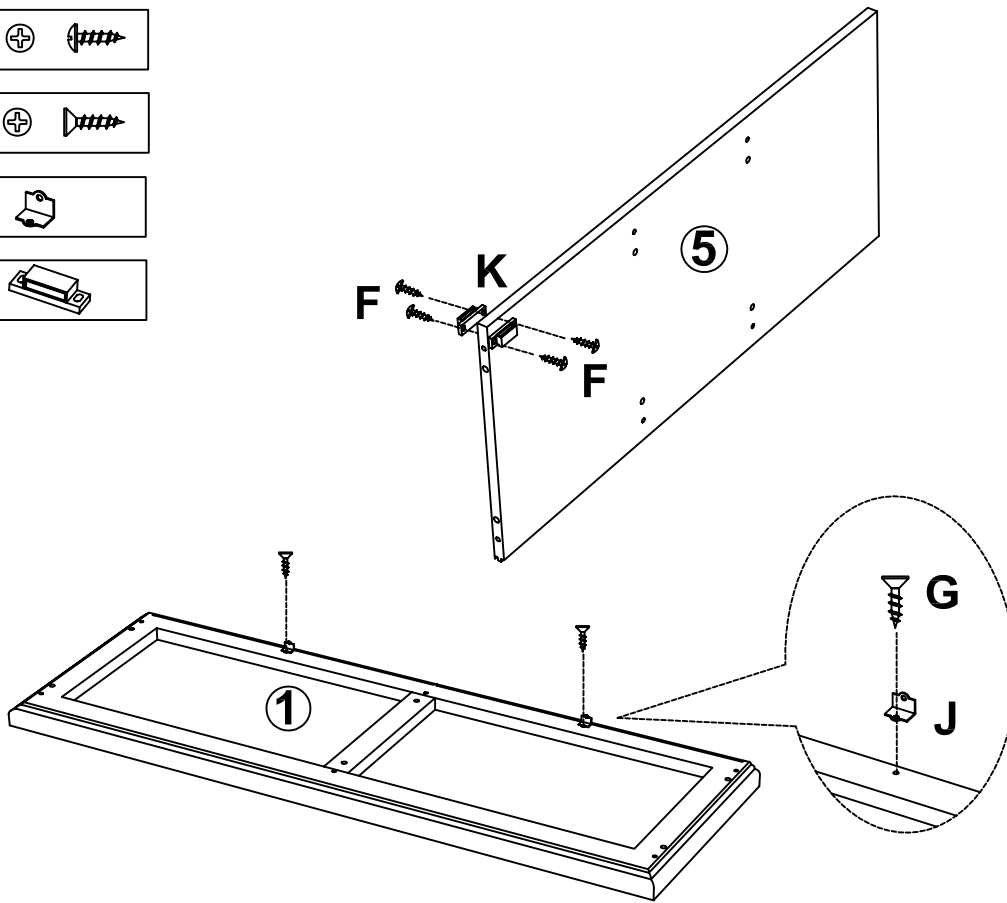

3

B X 4 

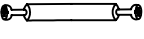
D X 2 

E X 2  8 X 50

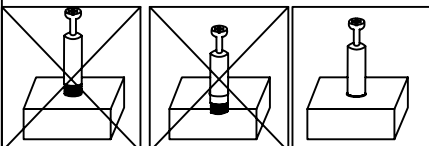
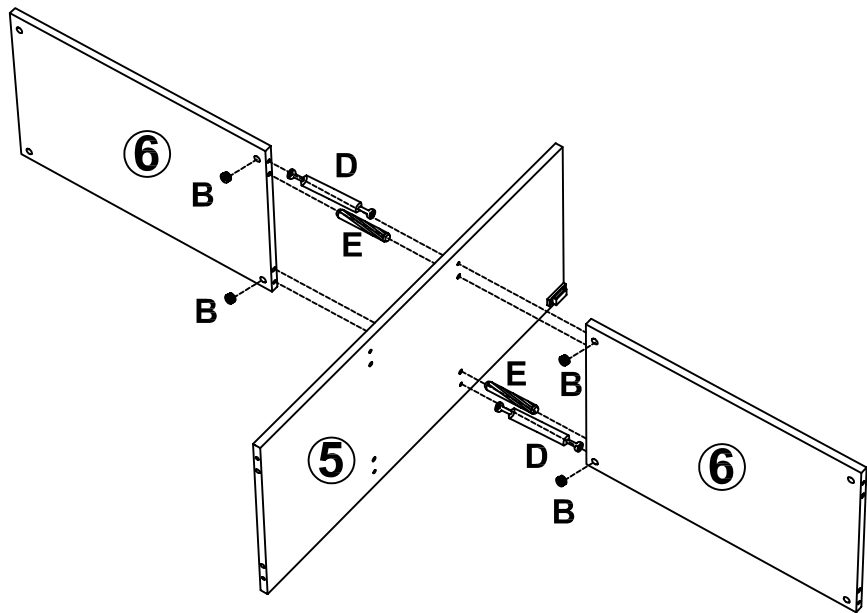

4

B X 4 

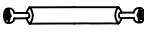
D X 2 

E X 2  8 X 50

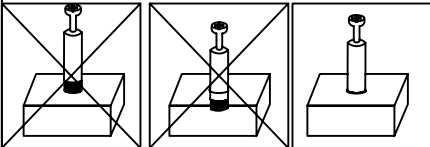
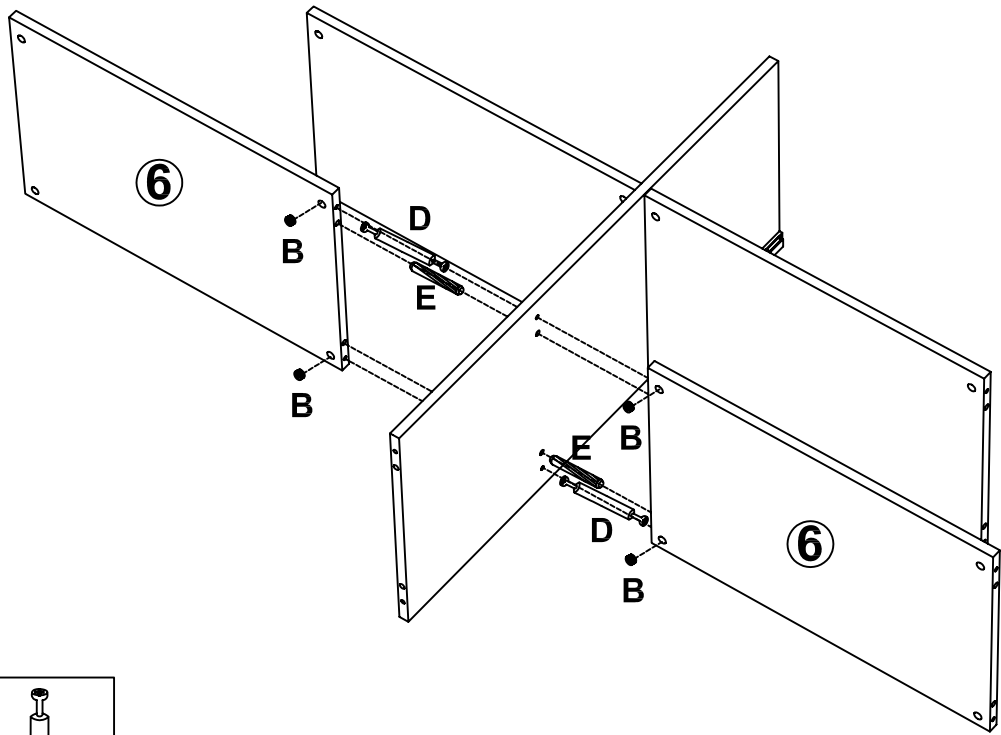

5

A X 8 

B X 8 

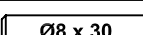
C X 8  Ø8 x 30

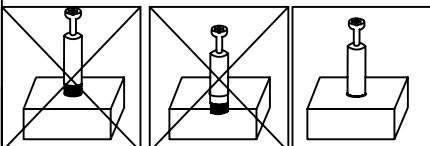
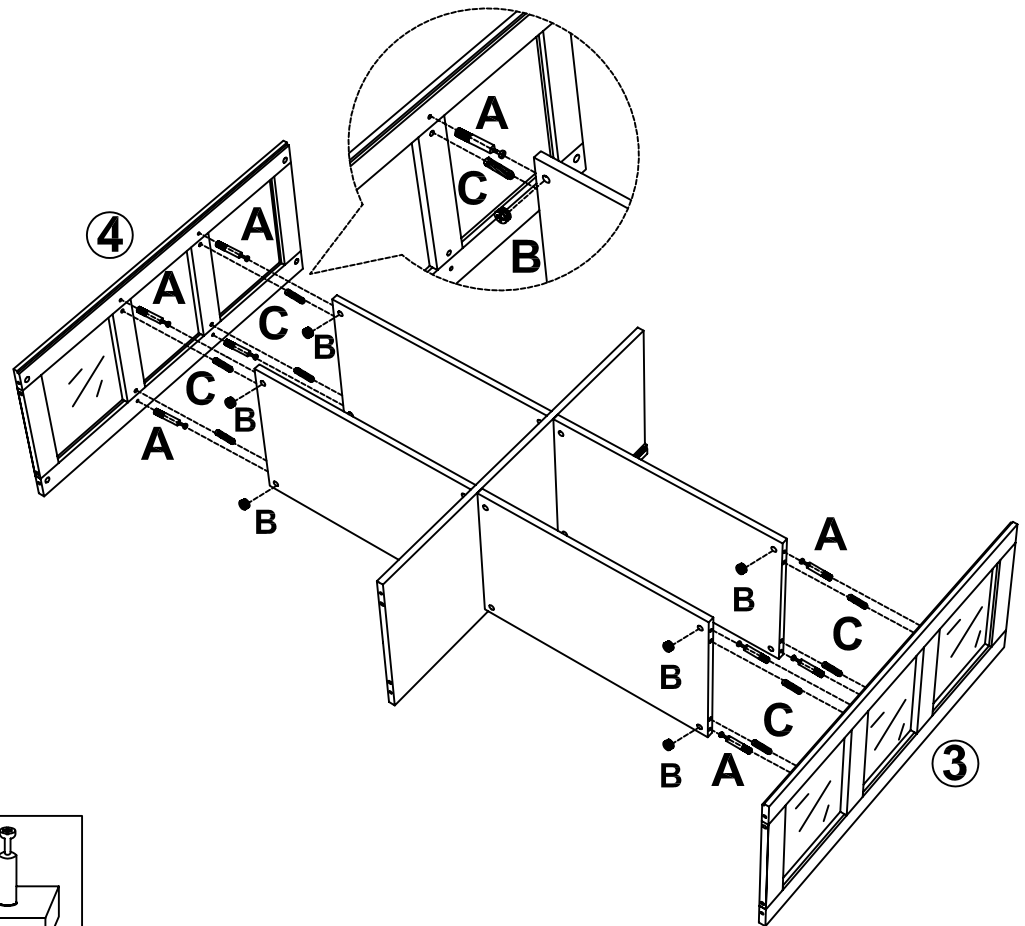

6

A X 6 

B X 6 

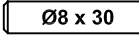
C X 6 

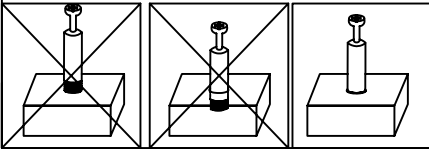
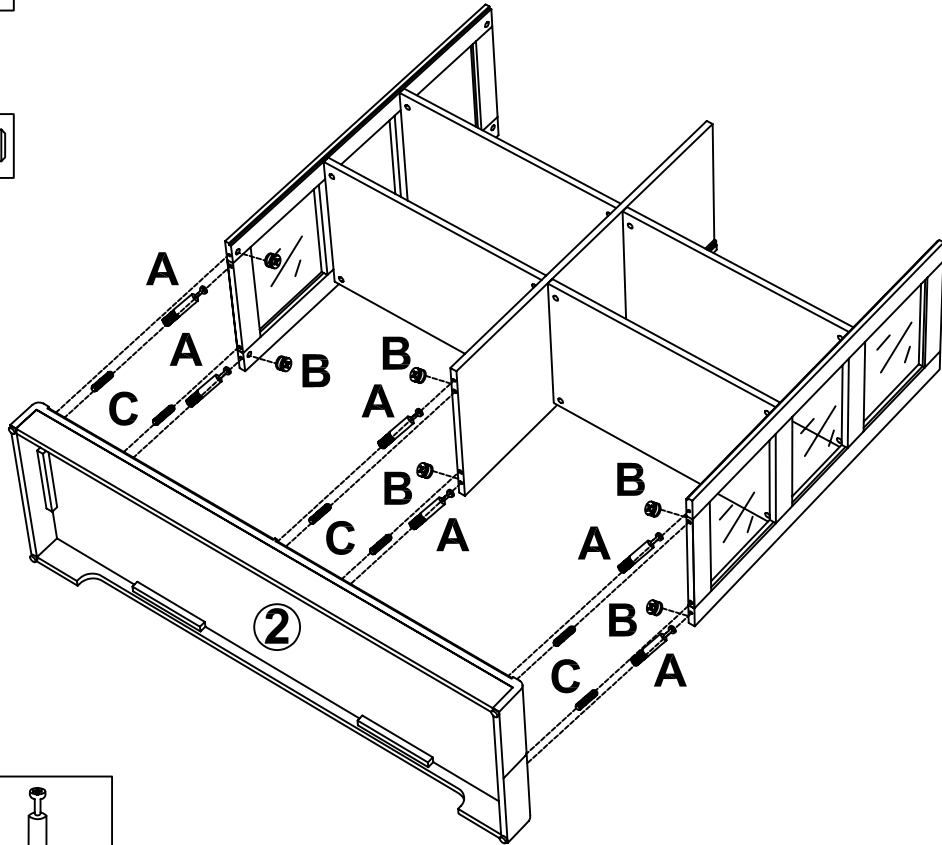

7

A X 6 

B X 6 

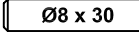
C X 6 

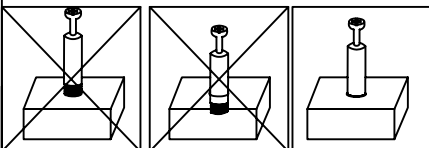
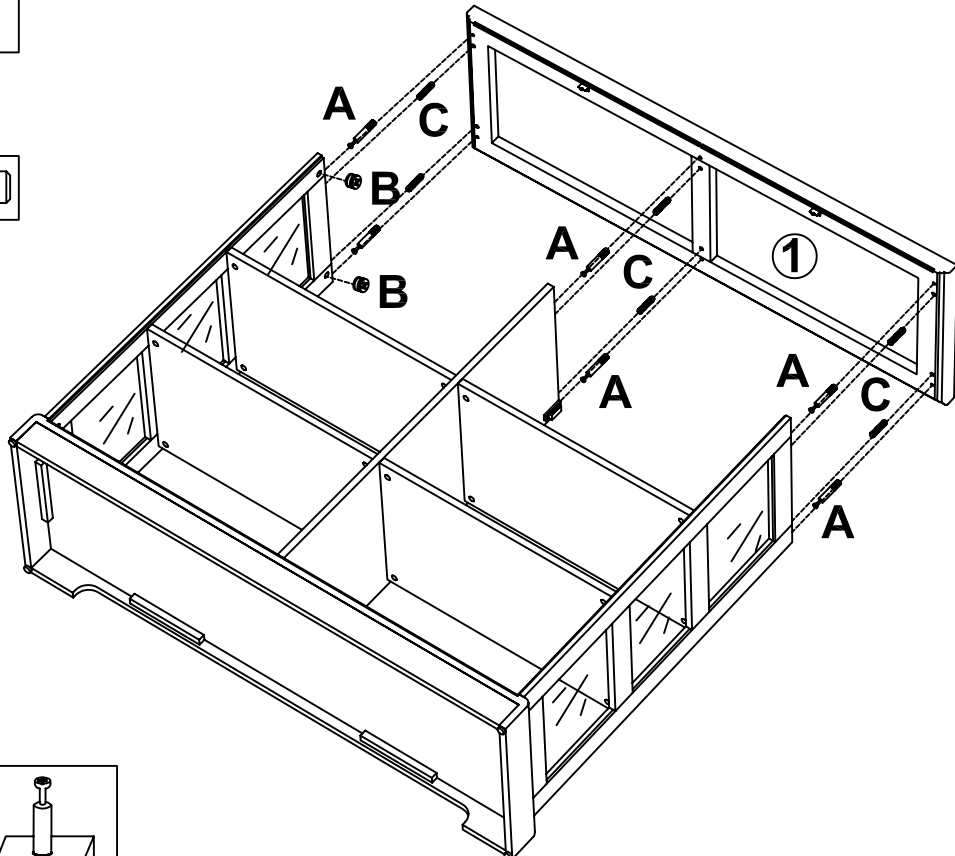

8

H X 23 

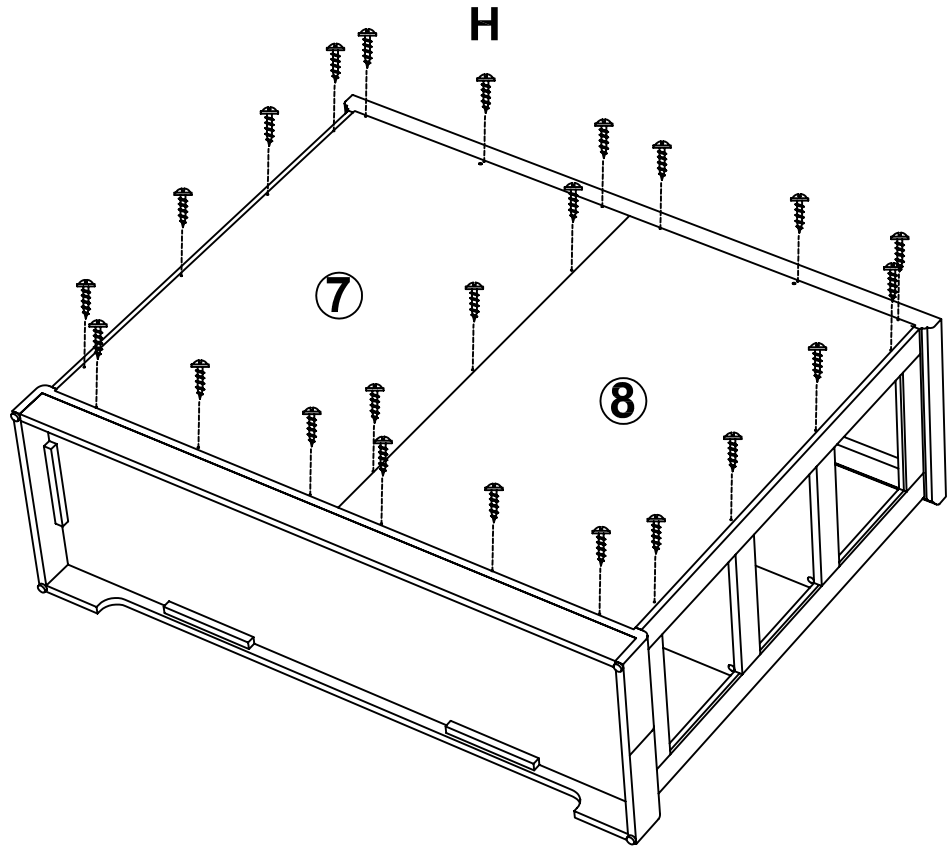

9

G X 4 

I X 1 

M X 1 

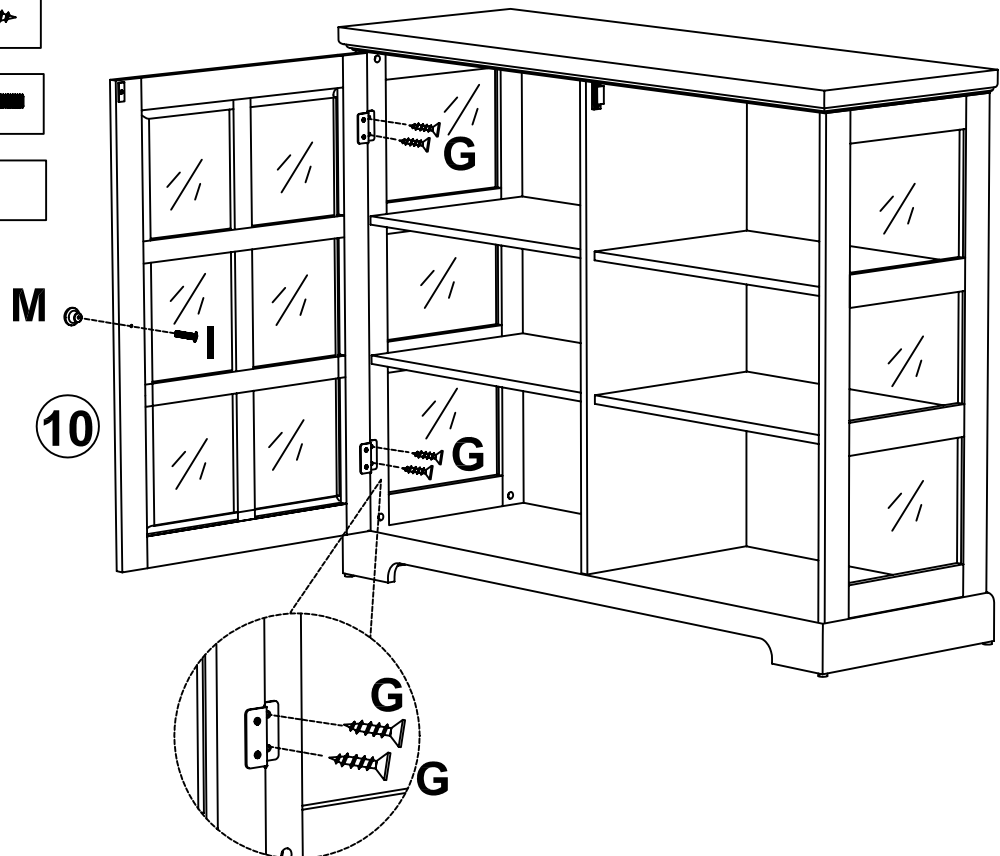

10

G X 4  

I X 1  

M X 1 

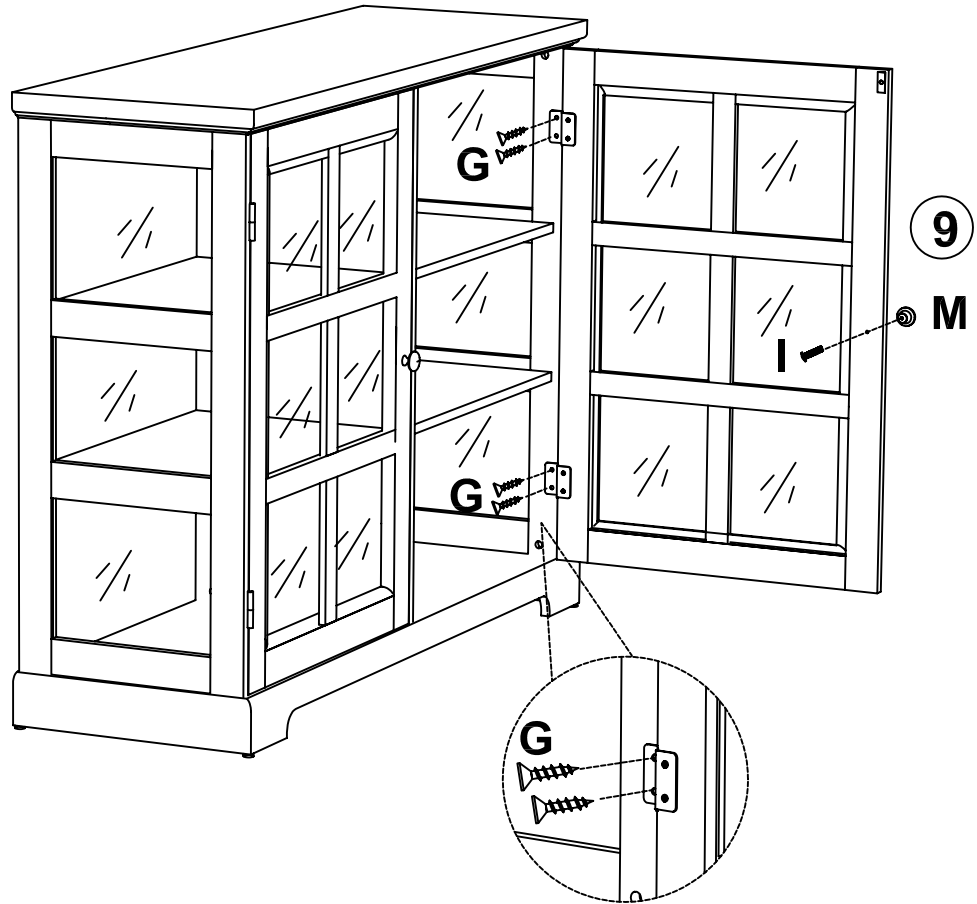

11

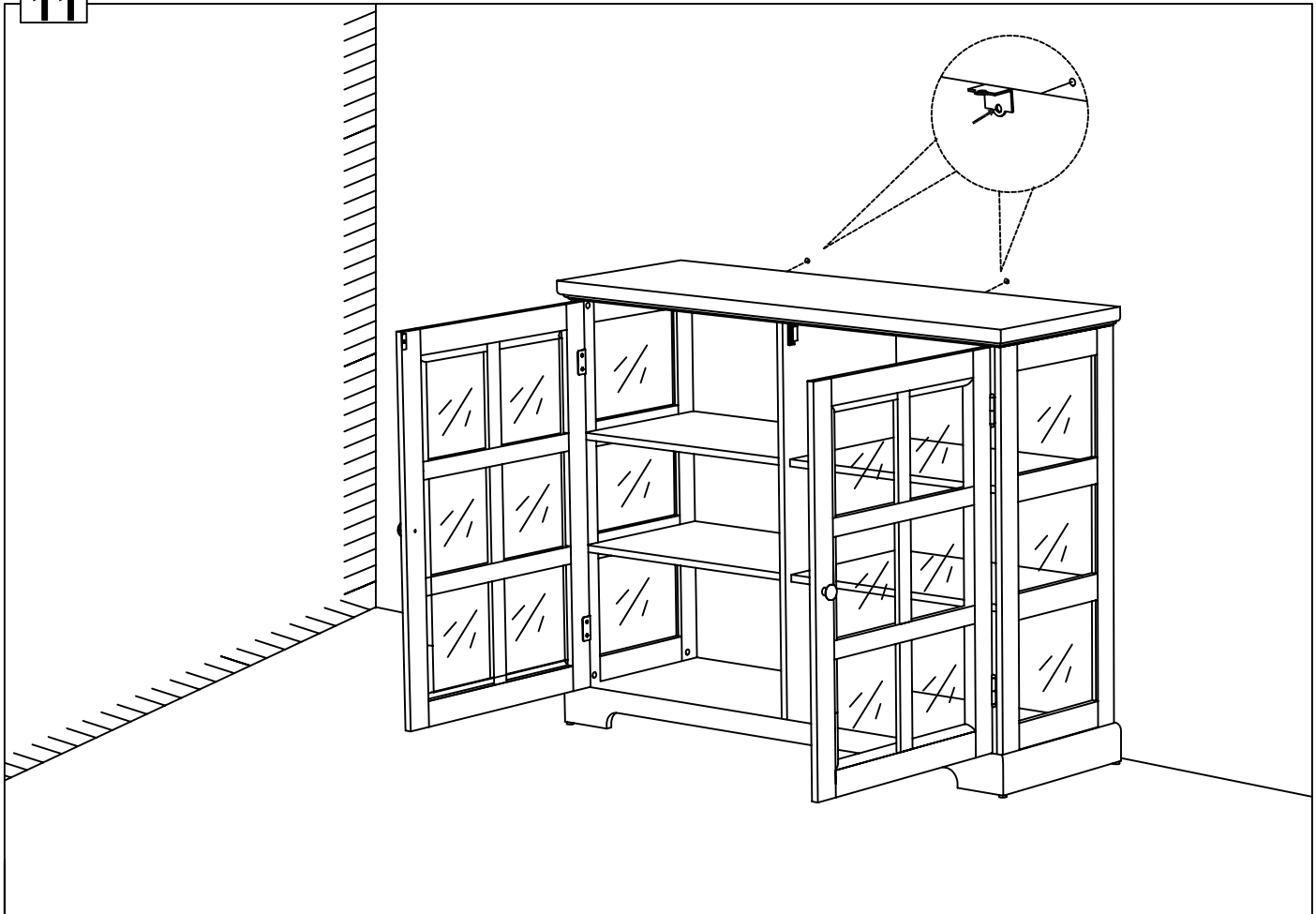



Il existe une grande diversité de types de murs ou cloisons, c'est la raison pour laquelle nous ne pouvons vous fournir le type exact de fixation. Il est nécessaire d'identifier le type de paroi à laquelle vous allez fixer ce produit afin de vous procurer les fixations appropriées. Voici quelques exemples de fixations conseillées pour :



LES MURS PLEINS

**CHEVILLE NYLON
"FISCHER"**

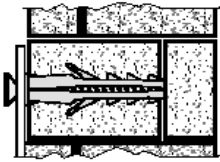
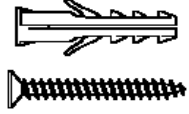

**CHEVILLE D'ANCRAGE
MÉTAL**

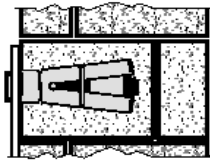
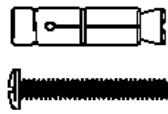

**CHEVILLE D'ANCRAGE
A AILETTES EN NYLON**

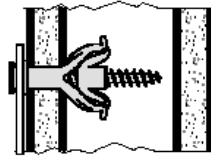

LES CLOISONS CREUSES

**CHEVILLE MÉTALLIQUE
A EXPANSION**

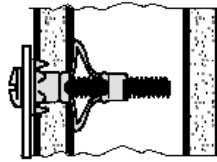
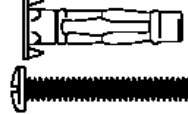

CHEVILLE "MOLLY"

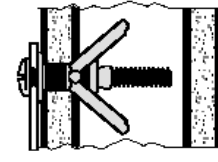
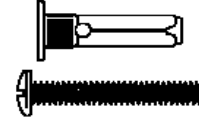

Utiliser une taille de forêt adaptée à la quincaillerie utilisée et au type de mur.



Due to the wide diversity of wall or partition types, we cannot provide you with suitable attachment fixtures. To determine which attachment fixtures to use, you will need to identify the type of wall to which you will be fixing this product. Here are some examples of attachment fixtures recommended for:

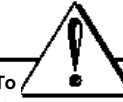

BLIND WALLS

**"FISCHER"
Nylon plug**

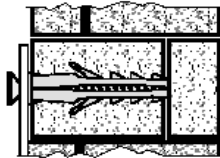
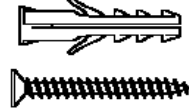

**Metal
Wall plug**

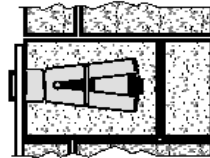
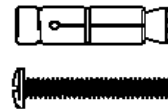

**Nylon winged
Wall plug**

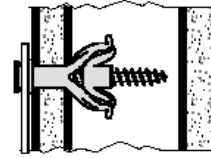
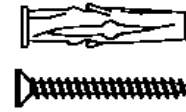

STUDDED WALLS

**Metal expansion
plug**

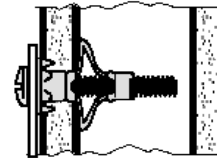
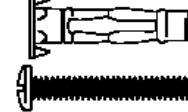

"MOLLY" plug

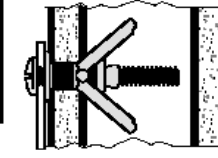
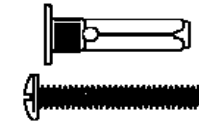

Use a drill bit that is compatible in size with the hardware used and the type of wall.



Esiste una gran varietà di tipi di muri o paratie e noi siamo in grado di fornirvi il tipo esatto di fissaggio per ognuno di essi. E' necessario identificare il tipo di parete alla quale intendete fissare questo prodotto in modo da fornirvi i fissaggi più idonei. Ecco qualche esempio di fissaggi consigliati per :



I MURI PIENI

**TASSELLO NYLON
"FISCHER"**

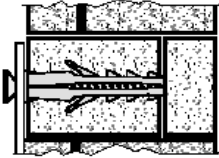
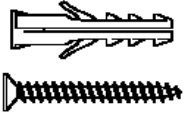

**TASSELLO DI
ANCORAGGIO IN
METALLO**

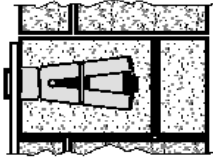
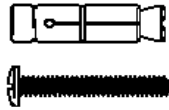

**TASSELLO DI
ANCORAGGIO AD
ALETTE IN NYLON**

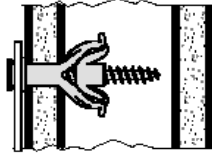

**PARATIE CAVE
TASSELLO METALLICO
AD ESPANSIONE**

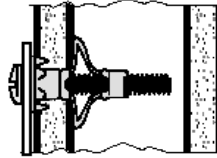
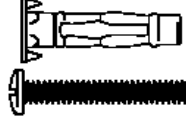

**TASSELLO
"MOLLY"**

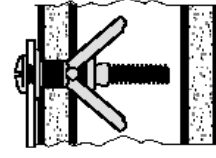
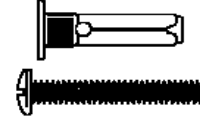

Utilizzare una punta di trapano adatta agli utensili utilizzati e al tipo di muro.



Es gibt eine Vielzahl verschiedener Arten von Mauern oder Zwischenwänden, und aus diesem Grunde können wir Ihnen den genau entsprechenden Befestigungstyp nicht bereitstellen. Zunächst ist es erforderlich, die exakte Bauart der Wand zu ermitteln, an der Sie dieses Produkt anbringen werden, um die für diese Wand geeigneten Befestigungsmittel im Fachhandel erwerben zu können. Nachfolgend einige Beispiele empfohlener Befestigungen für:



VOLLWÄNDE

**NYLONDÜBEL
„FISCHER“**

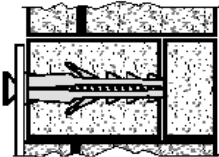
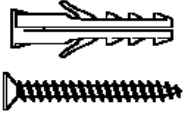

**ANKERDÜBEL
AUS METALL**

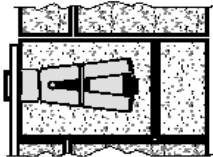
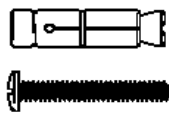

**ANKERDÜBEL MIT
NYLONFLÜGELN**

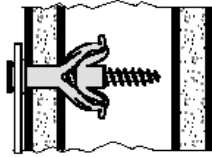
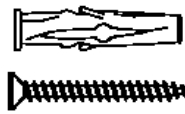

**HOHLWÄNDE
SPREIZDÜBEL FÜR
VERANKERUNG AUS METALL**

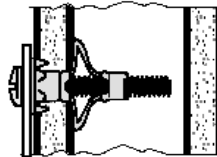
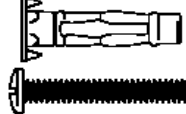

MOLLY-DÜBEL

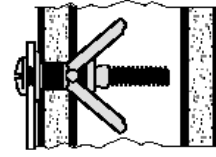
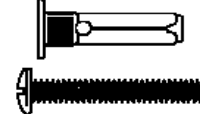

Bitte verwenden Sie eine für die Eisenwaren und den Wandtyp geeignete Bohrergröße.