

# SIMMONS UPHOLSTERY RECLINER / MOTION SETUP

Congratulations, you have received a Simmons recliner / motion product. Please follow the setup instructions below. Your recliner will arrive with the back unattached. See figure 1.

**NOTE: The illustrations shown may not reflect the model of chair that you own.**

To Attach the Back Portion of the Chair:

1. Remove packaging and check to ensure the locking clip is in the vertical position. Reposition **if** necessary. See figure 2.
2. Slide the left and right rear bracket sleeves of the chair back onto the male brackets on the arms and seat of the chair. See figure 3.

**NOTE: Because of the chair width, you may have to slide on one side of the chair back at a time. If so, level the chair back before pressing down to lock into position.**

3. Push firmly on the top of the chair back to lock into position. Listen for a click on each side to ensure the chair back is locked in properly. See figure 4.

**NOTE: Pull upon the chair back to ensure that it is locked in place. If the back can be pulled off, then repeat back portion installation.**

4. Attach the chair back fabric to the hook and loop flaps on the bottom of the chair base. See figure 5.

To Remove the Back Portion of the Chair:

1. Remove the bottom of the back fabric from the hook and loop flaps on the chair base. See figure 6.
2. Using a large flat head screwdriver, **lift** the left and right clips of the chair back to raise the back from the brackets on the chair base. As you lift the clip, pull up on the back to **lift** that side over the lock. See figure 7.

**NOTE: You will have to do this step one side at a time due to the width of your chair.**

3. Lift the chair back up from the base of the chair. See figure 8.

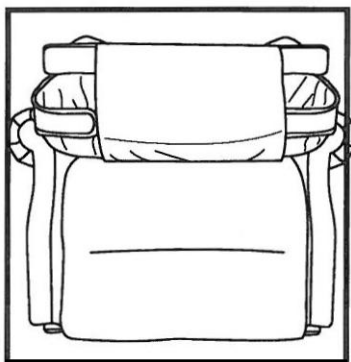

Figure 1. Knock-Down (KD) Position

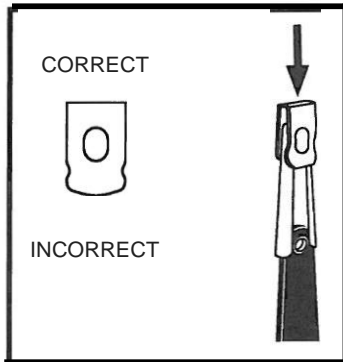

Figure 2. Locking Clip Position

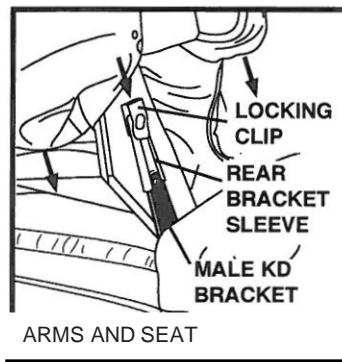

Figure 3. Sleeve and Bracket Connections

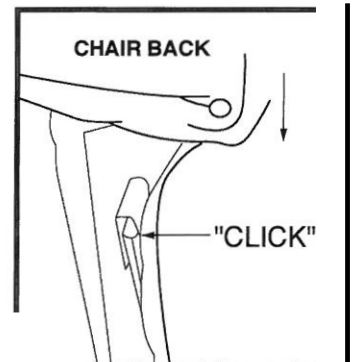

Figure 4. Position Lock

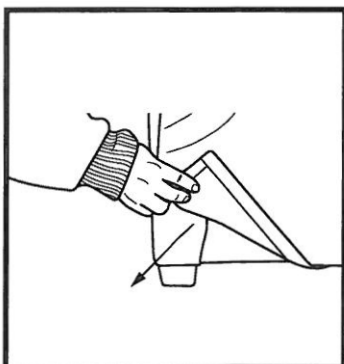

Figure 5. Chair Back Hook and Loop Flaps (Installation)

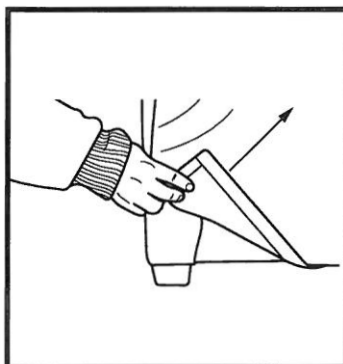

Figure 6. Chair Back Hook and Loop Flaps (Removal)

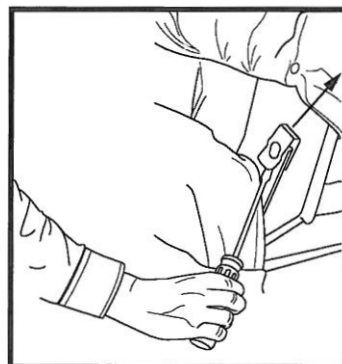

Figure 7. Clip Lifting

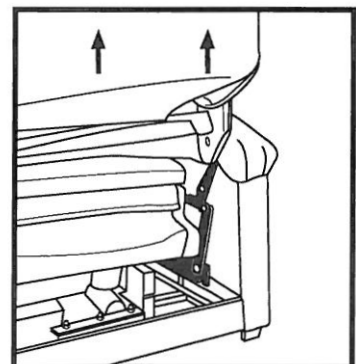

Figure 8. Chair Back Removal