

**IMPORTANT – Please read these instructions carefully before assembling**

## GL0151 Polycarbonate gazebo 4x3m Assembly Instructions

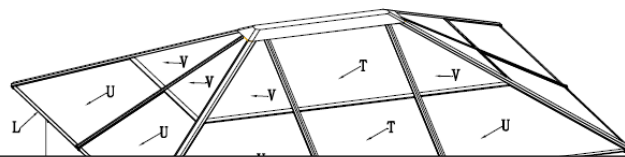

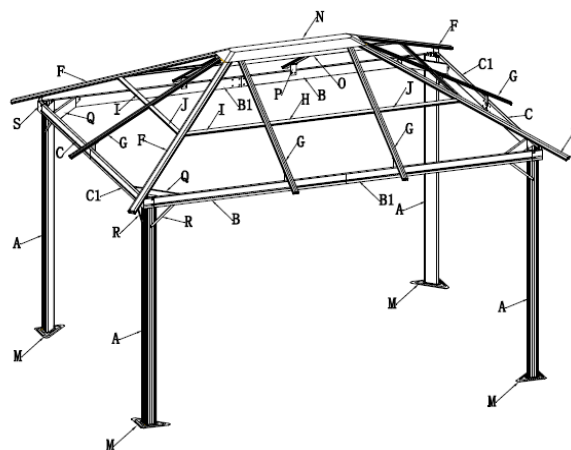





















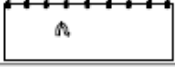
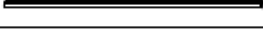

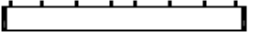

















**WE RECOMMEND 2 PEOPLE TO ASSEMBLE THIS GAZEBO**

If you need help with assembly or missing parts please call our customer care team on: 0121 616 1939

Please check if you have all the parts as listed **Note:** The quantities below are the correct amount to complete the assembly. In some cases more fittings may be supplied than are required.

## KWAPO37 3x4M

No		Qty	No		Qty
A		4	S		4
B		2	T		4
B1		2	U		8
C		2	V		8
C1		2	W		4
D		4	X		6
E		4	Y		4
F		4	Z1		4
G		6	Z2		4
H		2	Z3		2
I		4	Z4		2
J		4	Pulley		72
K		4	X1	 M6*15	114
L		8	X2	 M6*35	16
M		4	X3	 M4*10	20
N		1	X4	 M6*20	12
O		1	X5	 M6*40	16
P		6	X6		8
P1		4	X7		8
Q		4	X8		8
R		8		 M6	2
				 M6	2
					12
					1

Dimensions EXTERNAL	
Width	400 cm
Depth	300 cm
Height	280 cm

Assembly Requirements	
Number of people required to assemble	2
Approximate assembly time	3-4 Hours

If you need help with assembly or missing parts please call our customer care team on: 0121 616 1939

# Assembly Instructions

## Step 1 & 2

Connect all the leg uprights (A) first with the cross members B + B1 & C + 1 also connect the foot plates M to the uprights and include the bracket support bars Q & R. once the diagram is complete you can do the same for the other half of the gazebo.

Now join the 2 halves together with connection insert Y and screw into place this will strengthen the frame

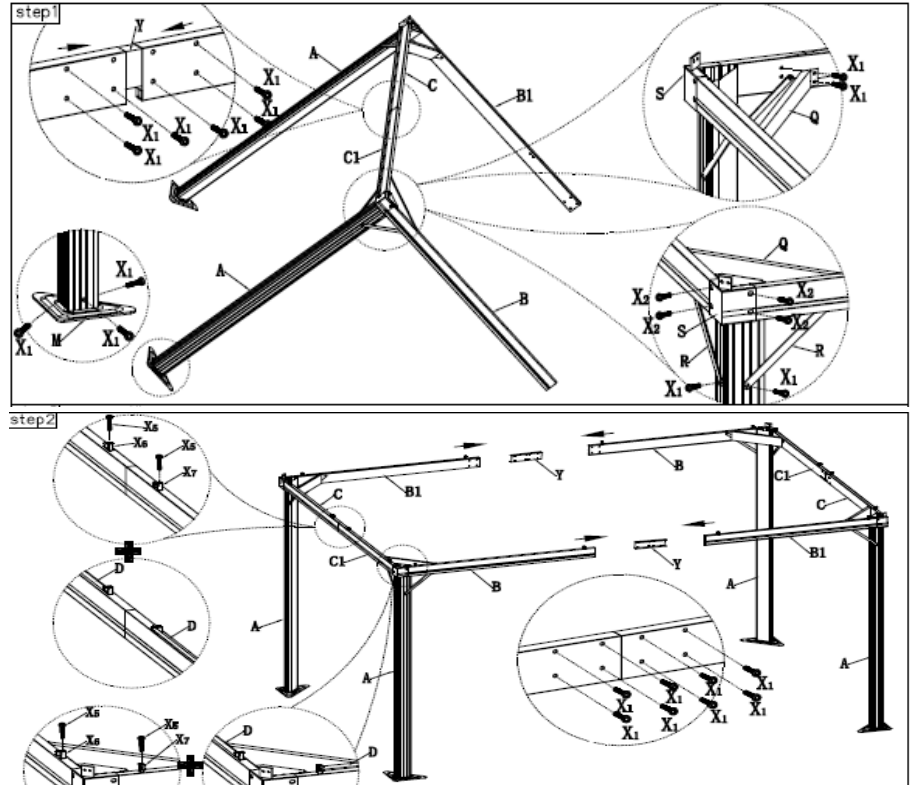

## Step 3 & 4

Join the 4 roof bars by connecting them with the top section o, ensuring they are at the correct position as the photo inset. Add the roof supports to the frame with part P1

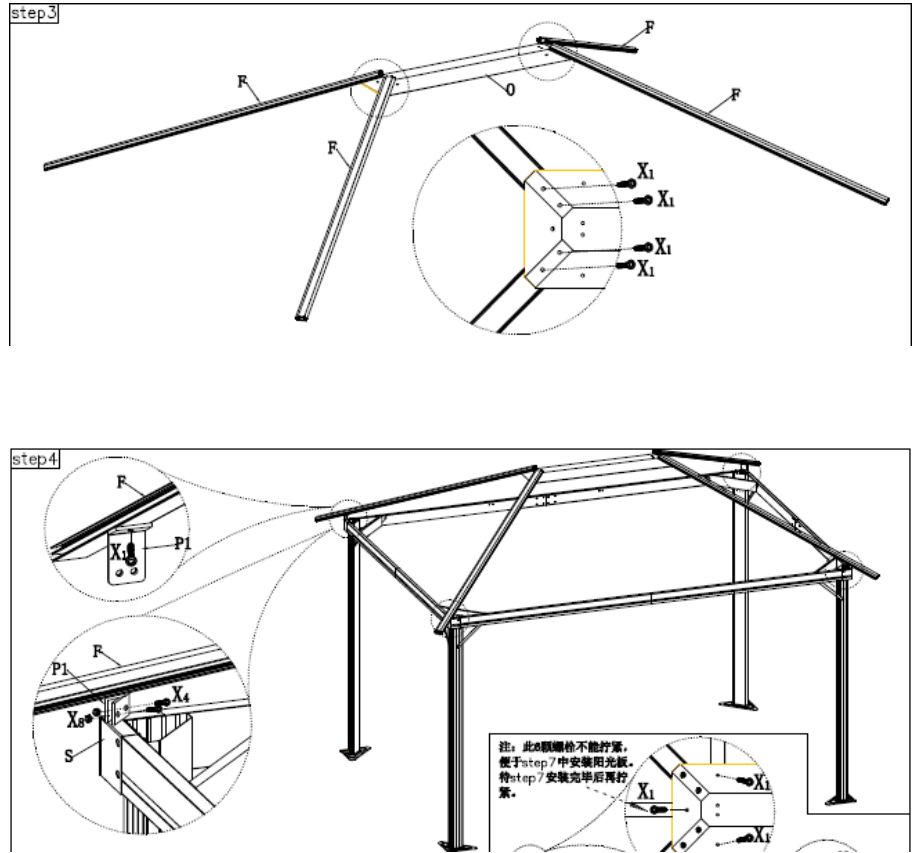

If you need help with assembly or missing parts please call our customer care team on: 0121 619 1939

### Step 5 & 6 & 7

Add all the side supporting sections G and secure onto the frame with part P

You can now proceed to start to slide the roof sections in V making sure the correct way up is inserted the roof is clearly marked, please remove the protective film and start with the top part first as shown. To secure the polycarbonate roof in place insert the holding bars in place part J

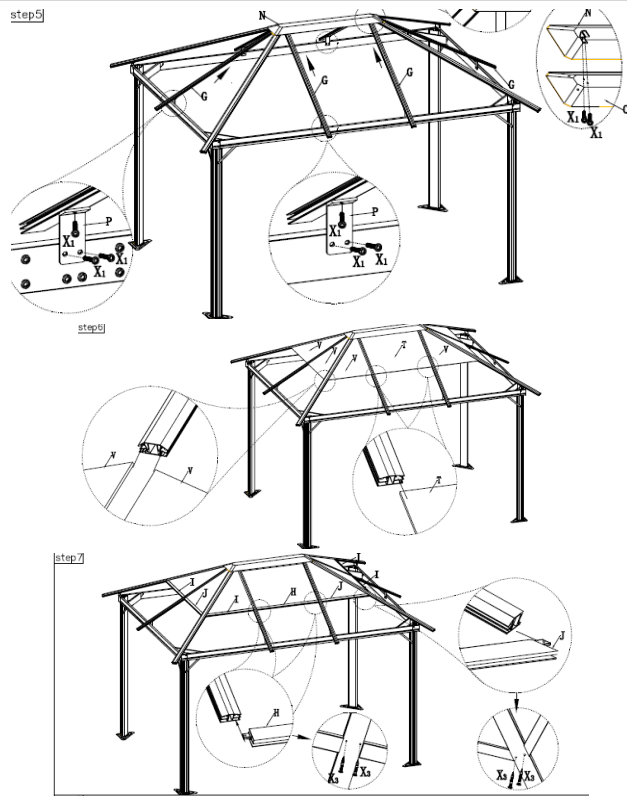

### Step 8 & 9 & 10 & 11

Continue adding the lower roof sections. Then add the end stop bar to the gazebo part L.

Secure it with clip X and bolt X1.

The structure should now be complete now add the curtains simply slide the pulley (curtain hooks) through the gap in the frame and attach the curtains.

Make sure all nuts & bolts are tightened and ensure the gazebo is fixed to the ground.

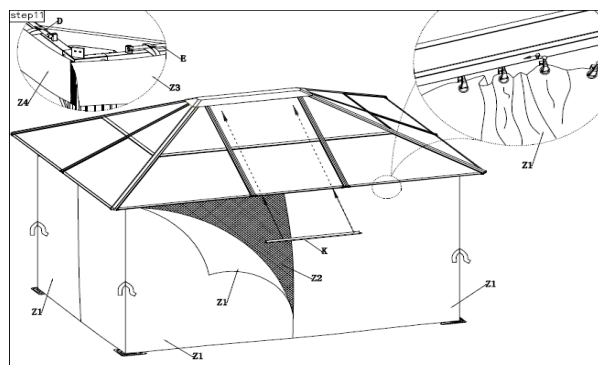
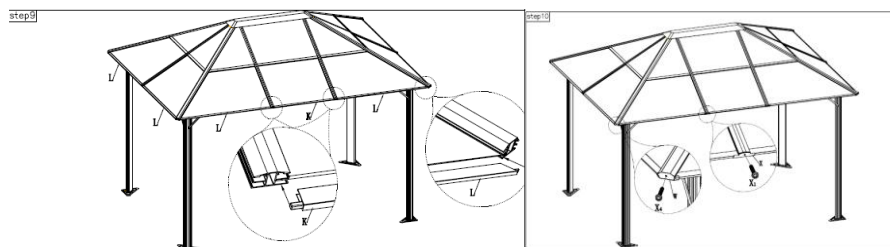
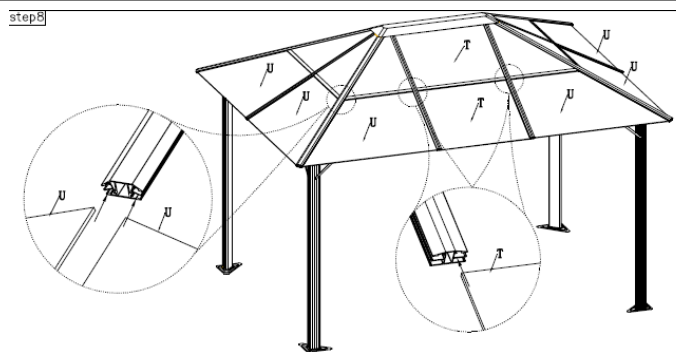

If you need help with assembly or missing parts please call our customer care team on: 0121 616 1939

## Safety and Care Advice

Your Gazebo frame can be left outside all year round but we advise the curtains are taken off during the winter months and stored in a cool dry frost free place (do not store wet). This will prevent them from deteriorating.

**\*VERY IMPORTANT**

**YOU MUST SECURE YOUR GAZEBO TO THE GROUND AS SOON AS IT IS BUILT**

**Distributed by:**  
Glendale Leisure

46 Barn Street, Digbeth  
Birmingham B5 5QB

[www.Glendale-leisure.com](http://www.Glendale-leisure.com)

If you need help with assembly or missing parts please call our customer care team on: 0121 616 1939