

ASSEMBLY INSTRUCTIONS

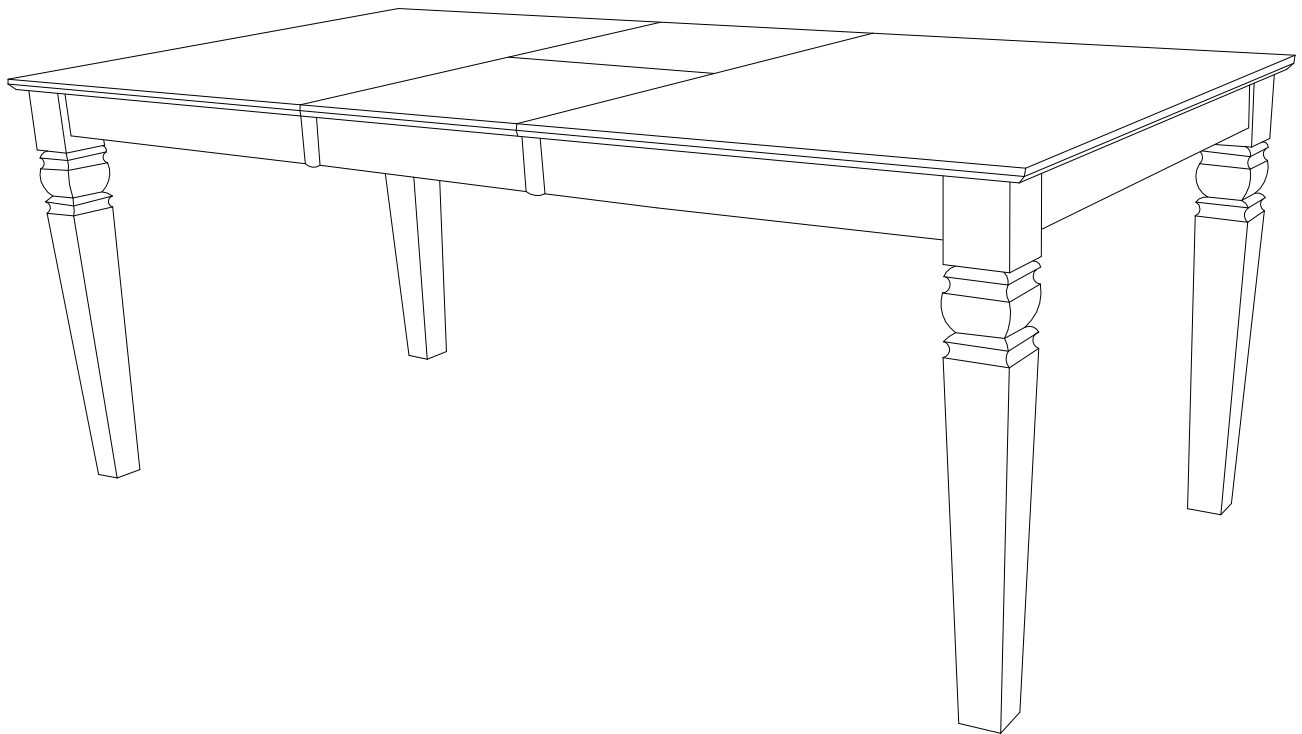

Description : COUNTER HEIGHT TABLE 18" CENTER LEAF

Dimension : W.40"x D.60"(78")x H.36"

Cube Size : 62.5"x42.5"x 6.5"

(Top)

NW: 96.8 LBS

GW: 101.2 LBS

Cube Size : 36.9"x13.7"x4"

(Leg)

NW: 33 LBS

GW: 35.2 LBS

COUNTER HEIGHT TABLE 18" CENTER LEAF

BEFORE ASSEMBLY

Thank you for purchasing this quality product. This product has been designed for easy assembly and constructed for durability. Please take the time to read and follow the assembly instructions carefully.

Be sure to check all packing material carefully for small parts which may have come loose inside the carton during shipment. Please separate, identify, and count all parts and metal hardware. Compare with part list to be sure all parts are present. If hardware is missing or you have difficulty assembling this product, please call for us.

IMPORTANT NOTE:

- Place all wooden parts on a clean and smooth surface such as a rug or carpet to avoid the parts from being scratched.
- Remove all wrapping material, including staples & packing straps before you start to assemble.
- DO NOT tighten all screws and bolts until completely assembled.
- Keep all hardware parts out of reach of children.

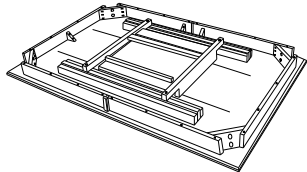
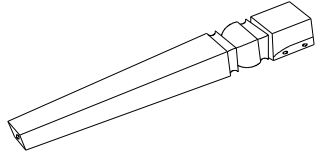

PART LIST

When unpacking, please be careful not to discard any parts with the packaging. Before continuing, please make sure you have the following parts:

NO	Description	Qty	Sketch	NO	Description	Qty	Sketch
A	Top	1		B	Table Leg	4	

HARDWARE LIST

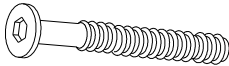
When unpacking, please be careful not to discard any parts with the packaging. Before continuing, please make sure you have all of the following hardware:

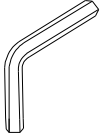
NO	Description	Qty	Sketch	NO	Description	Qty	Sketch
1	Bolt (M8x70)	8		2	Lock washer ($\Phi 8.5 \times \Phi 11 \text{mm}$)	8	
3	Flat Washer ($\Phi 8.5 \times \Phi 19 \text{mm}$)	8		4	Allen key (M4mm)	1	

STEP 1

Attach legs (B) to the top (A) with Bolts (1) and washers (2), (3). Tighten with the Allen Key (4).

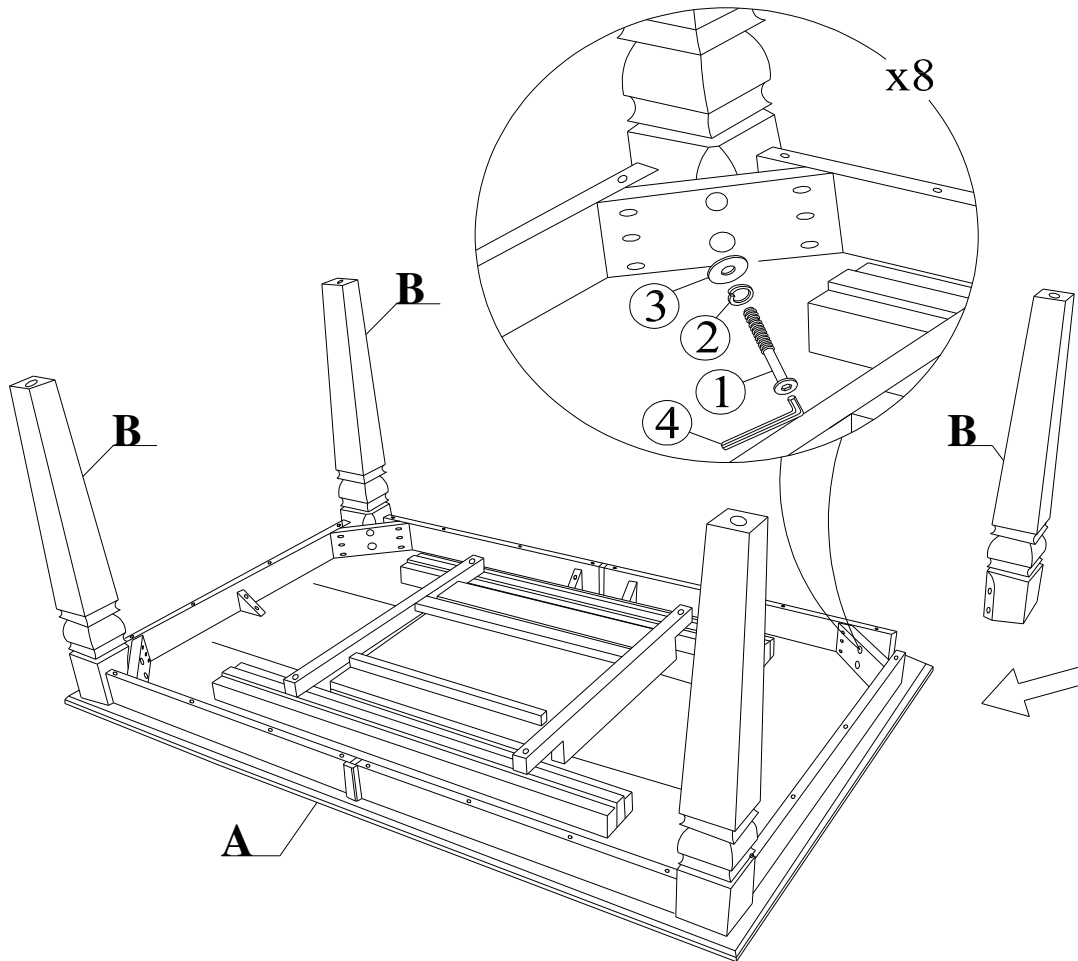

STEP 2

Unlock the table top from both sides underneath of the top as show below. Pull the 2 parts of the table top apart..

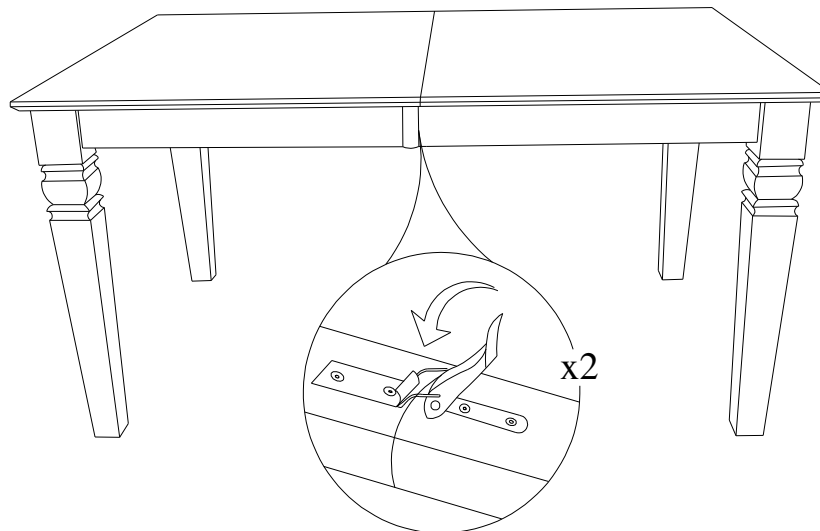

COUNTER HEIGHT TABLE 18" CENTER LEAF

STEP 3

Place the leaves in the center of the open table top. Push the table top closed. Lock the mechanism underneath 2 sides of the table top as shown below.

