

**NORTHERN MAPLE** : ÉRABLE DU NORD : *ARCE DEL NORTE*

**BARK GREY** : GRIS ÉCORCE : *CORTEZA GRIS*

**ASSEMBLY  
INSTRUCTIONS**

-----  
**INSTRUCTIONS  
D'ASSEMBLAGE**

-----  
**INSTRUCCIONES DE  
ENSAMBLAJE**

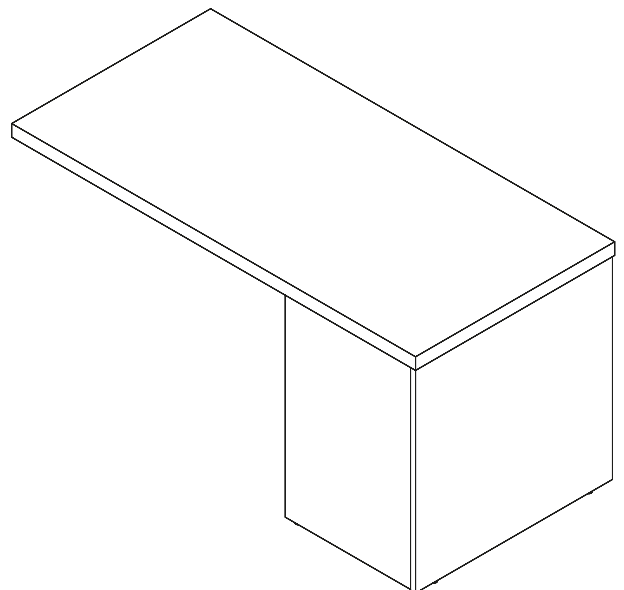
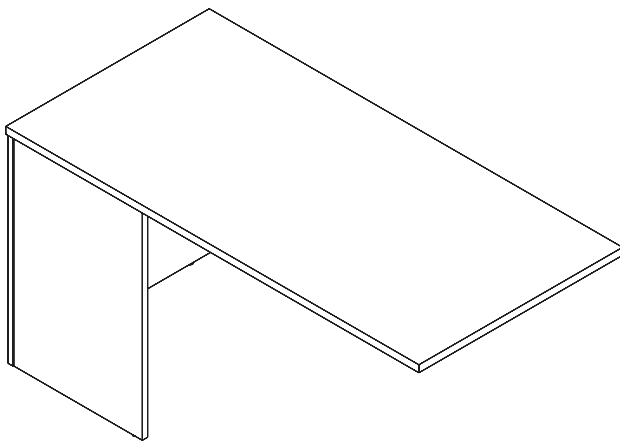

**Thank you for choosing a product.  
Your total satisfaction is our #1 priority.**

Customer Service and warranty information



**MERCI D'AVOIR CHOISI LES PRODUITS .  
VOUS SATISFAIRE EST NOTRE PRIORITÉ.**

**Service à la clientèle et informations relatives à la garantie**







***Gracias por elegir un producto .  
Su entera satisfacción es nuestra prioridad N°1.***

*Servicio de atención al cliente e información sobre la garantía*

▶ **PARTS / PIÈCES / PIEZAS**

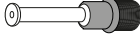
CODE / CÓDIGO	QTY / QTÉ / CANT.	CODE / CÓDIGO	QTY / QTÉ / CANT.	CODE / CÓDIGO	QTY / QTÉ / CANT.	CODE / CÓDIGO	QTY / QTÉ / CANT.
30	1	31	1	40	1		

▶ **HARDWARE / QUINCAILLERIES / QUINCALLA**

CODE / CÓDIGO	QTY / QTÉ / CANT.	CODE / CÓDIGO	QTY / QTÉ / CANT.	CODE / CÓDIGO	QTY / QTÉ / CANT.	CODE / CÓDIGO	QTY / QTÉ / CANT.
CA-77	 2	EQ-972	 2	H-36	 5	PA-844	 1" (25 mm) 3
CA-99	 6	H-03	 6				

▶ **REAL SIZE / GRANDEUR RÉELLE / TAMAÑO REAL**

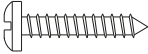
CODE / CÓDIGO	QTY / QTÉ / CANT.	CODE / CÓDIGO	QTY / QTÉ / CANT.
VR-210	 5/8" (16 mm) 8		

▶ **IMPORTANT NOTICE / NOTE IMPORTANTE / NOTA IMPORTANTE**

**H-03**

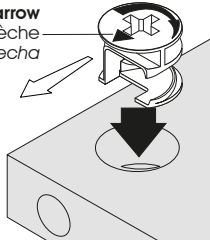

arrow  
flèche  
flecha

**Insert the cam with the arrow pointing towards the hole in the edge.**  
Insérez la rondelle en pointant la flèche vers le trou de la bordure.  
Inserte la arandela con la flecha apuntando hacia el orificio cercano al borde.

**Main hardware system / Système de quincaillerie principal / Sistema principal de quincalla**

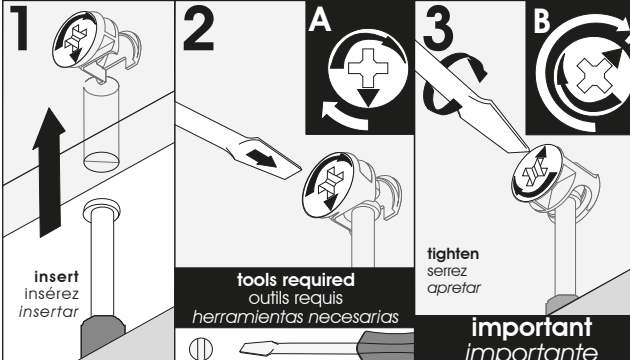

**1** insert / insérez / insertar

**2** **A** **B** tools required / outils requis / herramientas necesarias

**3** tighten / serrez / apretar

**important / importante**

**How to remove a misplaced assembly bolt (H-36).**  
Comment retirer un boulon (H-36) mal situé.  
Cómo retirar un perno (H-36) mal ubicado.

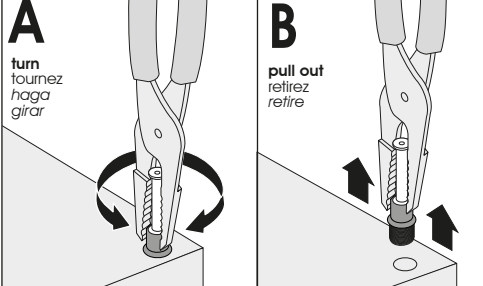

**A** turn / tournez / haga girar

**B** pull out / retirez / retire

▶ **PROBLEMS OR INFORMATION**

POUR TOUT PROBLÈME OU INFORMATION  
PROBLEMAS O INFORMACIÓN

## MONTAGE GAUCHE

**Assemble upside down**

Assemblez en position renversée

Realice el ensamblaje en posición invertida

**Assembling sequence**

Séquence d'assemblage

Secuencia de ensamblaje

**Parts / Pièces / Piezas:**

**40 30 31**

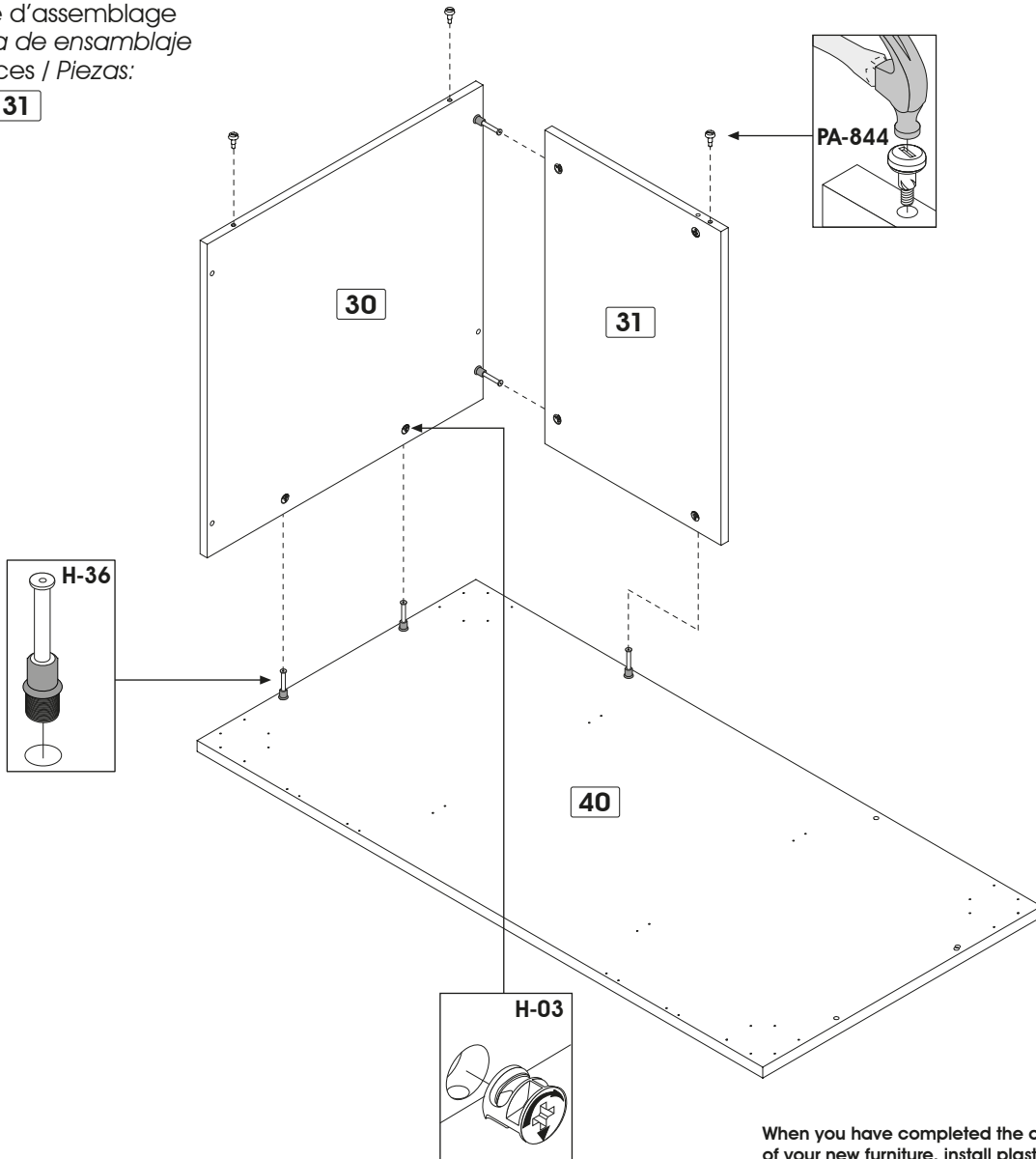

**When you have completed the assembly of your new furniture, install plastic caps.**

Lorsque vous avez complété l'assemblage de votre meuble, installez les capuchons de plastique.

Una vez que haya ensamblado el mueble, coloque los capuchones de plástico.

<b>1</b>			
<b>Code / Código</b>	H-03	H-36	PA-844
<b>Qty / Qté / Cant.</b>	x 6	x 5	x 3

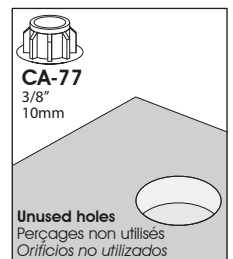
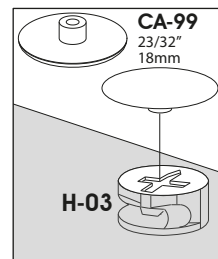

**Unused holes**  
Perçages non utilisés  
Orificios no utilizados

**MONTAGE DROIT**

**Assemble upside down**

Assemblez en position renversée

Realice el ensamblaje en posición invertida

**Assembling sequence**

Séquence d'assemblage

Secuencia de ensamblaje

**Parts / Pièces / Piezas:**

**40 30 31**

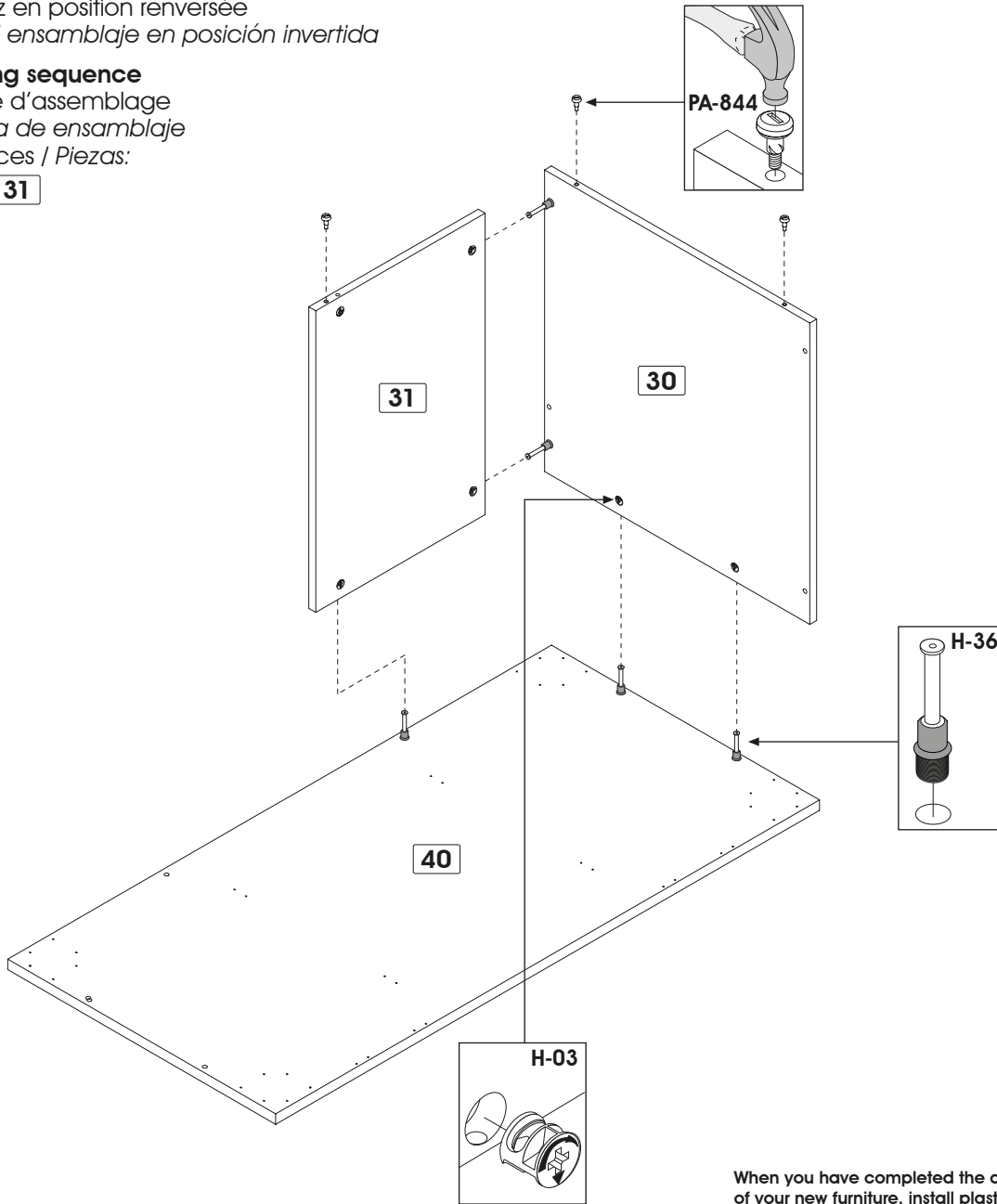

**When you have completed the assembly of your new furniture, install plastic caps.**

Lorsque vous avez complété l'assemblage de votre meuble, installez les capuchons de plastique.

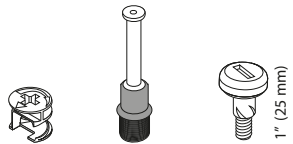

Una vez que haya ensamblado el mueble, coloque los capuchones de plástico.

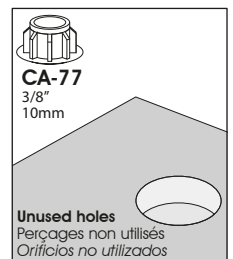
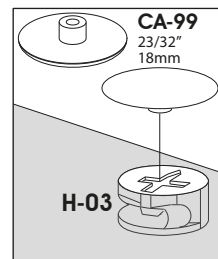

<b>Code / Código</b>	H-03	H-36	PA-844
<b>Qty / Qté / Cant.</b>	x 6	x 5	x 3

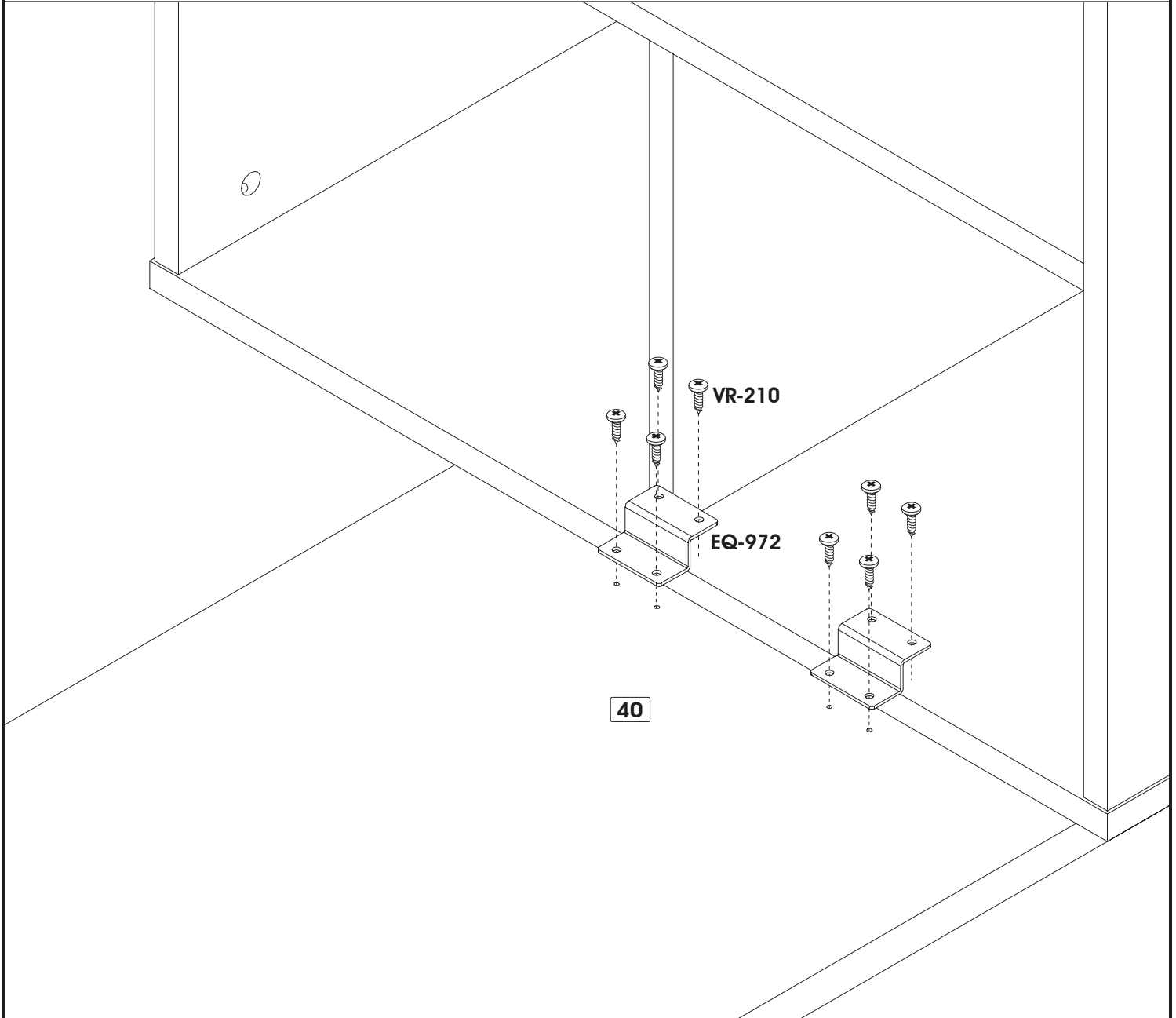
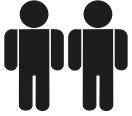



<b>2</b>		
Code / Código	EQ-972	VR-210
Qty / Qté / Cant.	x 2	x 8

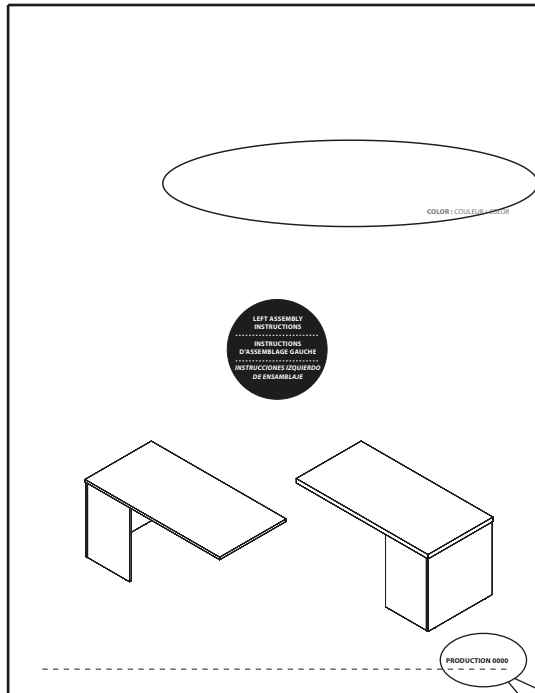

**PRODUCTION 0000**

**To better serve you!**  
Pour mieux vous servir!

→ **Model / Modèle :** \_\_\_\_\_

→ **Production Number**  
Numéro de production : \_\_\_\_\_

**Customer Service**  
Service à la clientèle

**For future reference and to better serve you, please apply the self-adhesive sticker in an accessible space such as inside a drawer.**

Pour mieux vous servir en cas de besoin, veuillez apposer l'autocollant dans un endroit facilement accessible tel que l'intérieur d'un tiroir.

*Para futura referencia y mejor servicio por favor pegue la etiqueta en un lugar accesible, por ejemplo al interior de un cajón.*

### PRODUCT CARE / ENTRETIEN DU PRODUIT / MANTENIMIENTO DEL PRODUCTO

**Avoid placing the furniture in the sunlight or near a source of heat. Use a soft dry cloth for dusting. To clean heavy dirt, use a cloth dipped in a solution of mild detergent and water. Avoid leaving wet objects on the surface or using commercial chemical cleaning products.**

Évitez d'exposer le meuble au soleil ou près de toute source de chaleur. Pour le nettoyage, utilisez un chiffon doux et sec. Pour la grosse saleté, utilisez un chiffon humidifié avec un peu de détergent dilué dans l'eau. Évitez de laisser des objets mouillés sur la surface de votre meuble ou d'utiliser des nettoyeurs chimiques.

*Evite exponer el mueble al sol o las fuentes de calor. Para limpiarlo, utilice un paño suave y seco. Para limpiar las manchas rebeldes, utilice un trapo húmedo con un poco de detergente diluido en agua. No deje objetos mojados encima del mueble ni utilice limpiadores que contengan productos químicos.*

**CONGRATULATIONS! YOU ARE NOW THE OWNER OF A QUALITY PRODUCT**  
FÉLICITATIONS! VOUS AVEZ MAINTENANT EN VOTRE POSSESSION UN PRODUIT DE QUALITÉ  
FELICITACIONES! AHORA ES USTED DUEÑO DE UN PRODUCTO DE CALIDAD.



**For more information or to discover our new products**

Pour toute information ou pour découvrir nos nouveaux produits

*Para obtener más información o para obtener nuevos productos*

