

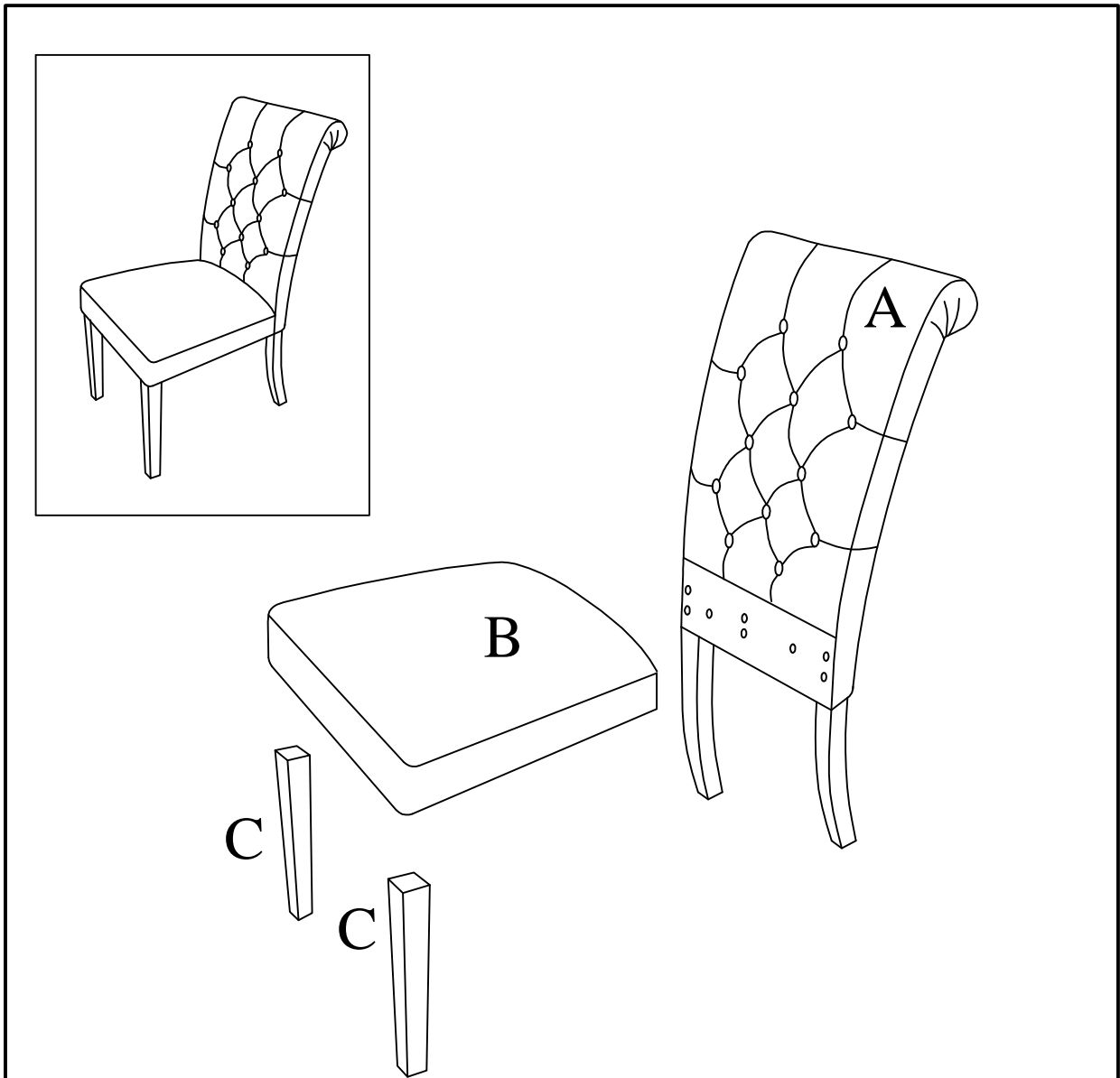





ASSEMBLY INSTRUCTIONS INSTRUCTION D'ASSEMBLAGE

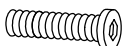

TURN TOP UPSIDE DOWN ON A SOFT WORKING SURFACE.

RETOURNEZ LE MEUBLE DANS L' AUTRE SENS SUR UNE SURFACE DE TRAVAIL NON RIGIDE.

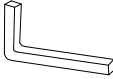
<p>a  10 pcs / unités</p>	<p>b  10 pcs / unités</p>	<p>c  3-1/2" 4 pcs / unités</p>
<p>d  2-1/2" 4 pcs / unités</p>	<p>e  2" 3 pcs / unités</p>	<p>f  1 pc / unités</p>

ASSEMBLY INSTRUCTIONS INSTRUCTION D'ASSEMBLAGE

STEP 1 / ÉTAPE 1

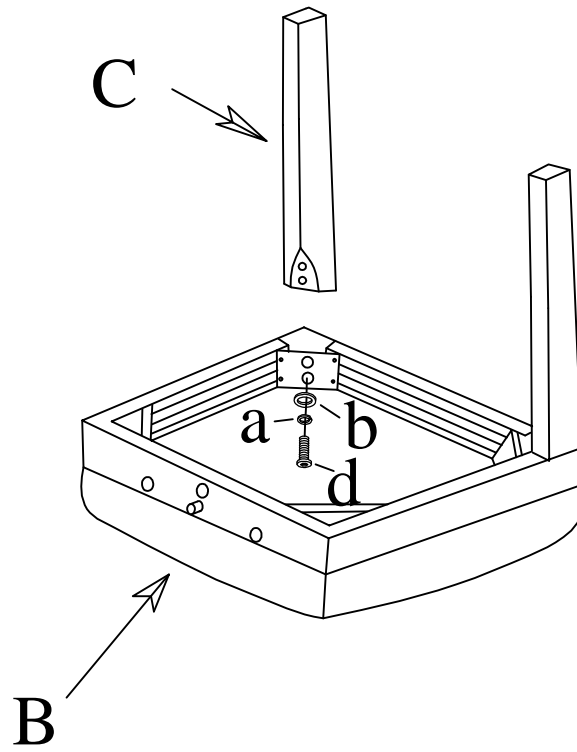

STEP 2 / ÉTAPE 2

