

**BUREAU EN COIN GAUCHE / DROIT STYLE VIEUX BOIS NATUREL
NATURAL RECLAIMED-LOOK LEFT / RIGHT FACING CORNER DESK**







**INSTRUCTIONS D'ASSEMBLAGE
ASSEMBLY INSTRUCTIONS**



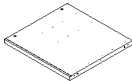

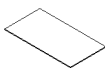

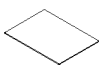

**POUR DE L'ASSISTANCE OU POUR COMMANDER
DES PIÈCES CONTACTEZ NOTRE DÉPARTEMENT
DE SERVICE À LA CLIENTÈLE.**

**FOR ASSISTANCE OR TO ORDER PARTS
CONTACT OUR CUSTOMER SERVICE DEPARTMENT**

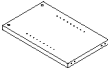

IDENTIFICATION DES PIÈCES
PARTS IDENTIFICATION

1		PANNEAU CÔTÉ GAUCHE LEFT SIDE PANEL	1MC 1PC
2		PANNEAU CÔTÉ DROIT RIGHT SIDE PANEL	1MC 1PC
3		PANNEAU DU BAS BOTTOM PANEL	1MC 1PC
4		PANNEAU DU DESSUS TOP PANEL	1MC 1PC
5		PANNEAU ARRIÈRE BACK PANEL	1MC 1PC
6		PANNEAU DEVANT DU TIROIR DRAWER FRONT PANEL	1MC 1PC
7		PANNEAU ARRIÈRE DU TIROIR DRAWER BACK PANEL	1MC 1PC
8		PANNEAU CÔTÉ GAUCHE DU TIROIR LEFT DRAWER SIDE PANEL	1MC 1PC
9		PANNEAU CÔTÉ DROIT DU TIROIR RIGHT DRAWER SIDE PANEL	1MC 1PC
10		PANNEAU DU FOND DU TIROIR DRAWER BOTTOM PANEL	2MCX 2PCS

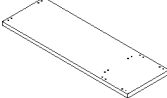
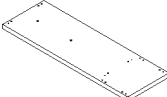
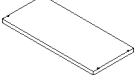
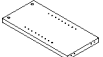

IDENTIFICATION DES PIÈCES
PARTS IDENTIFICATION

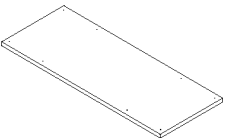
11		PANNEAU DEVANT DU TIROIR DRAWER FRONT PANEL	2MCX 2PCS
12		PANNEAU ARRIÈRE DU TIROIR DRAWER BACK PANEL	2MCX 2PCS
13		PANNEAU CÔTÉ GAUCHE DU TIROIR LEFT DRAWER SIDE PANEL	2MCX 2PCS
14		PANNEAU CÔTÉ DROIT DU TIROIR RIGHT DRAWER SIDE PANEL	2MCX 2PCS
15		PANNEAU CÔTÉ GAUCHE LEFT SIDE PANEL	1MC 1PC
16		PANNEAU CÔTÉ DROIT RIGHT SIDE PANEL	1MC 1PC
17		PANNEAU DU BAS BOTTOM PANEL	1MC 1PC
18		PANNEAU DU DESSUS TOP PANEL	1MC 1PC
19		PANNEAU AJUSTABLE ADJUSTABLE PANEL	1MC 1PC
20		PANNEAU DE DIVISION DIVIDER PANEL	2MCX 2PCS





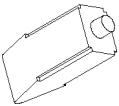
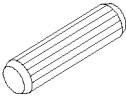
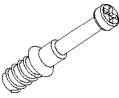

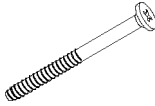

IDENTIFICATION DES PIÈCES
PARTS IDENTIFICATION

21		PANNEAU AJUSTABLE ADJUSTABLE PANEL	2MCX 2PCS
22		DESSUS DE TABLE TABLE TOP	1MC 1PC
23		PANNEAU DE TABLE DE CLOISON TABLE TOP PARTITION BOARD	2MCX 2PCS
24		PANNEAU DU FOND DU TIROIR DRAWER BOTTOM PANEL	1MC 1PC

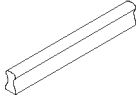

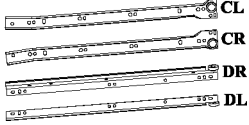
IDENTIFICATION DES PIÈCES DE MONTAGE
HARDWARE IDENTIFICATION

A		COLLE/GLUE(40g)	1MC/PC
B		ø8x30mm	34MCX/PCS
C		35.5mm	18MCX/PCS
D		ø15x12mm	18MCX/PCS

IDENTIFICATION DES PIÈCES DE MONTAGE
HARDWARE IDENTIFICATION

E		35mm	20MCX/PCS
F		55mm	14MCX/PCS
G		φ4.9x15mm	12MCX/PCS
H		L 120mm	3MCX/PCS
I		22.5mm	6MCX/PCS
J		L 400mm	2ENS/SET
K		10mm	42MCX/PCS
L		50x50x18mm	9MCX/PCS
M		25.5mm	18MCX/PCS
N		M6x38mm	4MCX/PCS

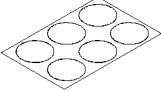
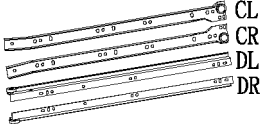
IDENTIFICATION DES PIÈCES DE MONTAGE HARDWARE IDENTIFICATION

O		$\phi 20\text{mm}$	3MCX/PCS
P		L 450mm	1ENS/SET
Q		$\phi 4.8 \times 293\text{mm}$	2MCX/PCS

ÉTAPE / STEP 1

La colle (A) doit être utilisée aux endroits indiqués afin de solidifier l'étagère assemblée.
The Glue (A) should be used in the indicated locations to help solidify the assembled unit.

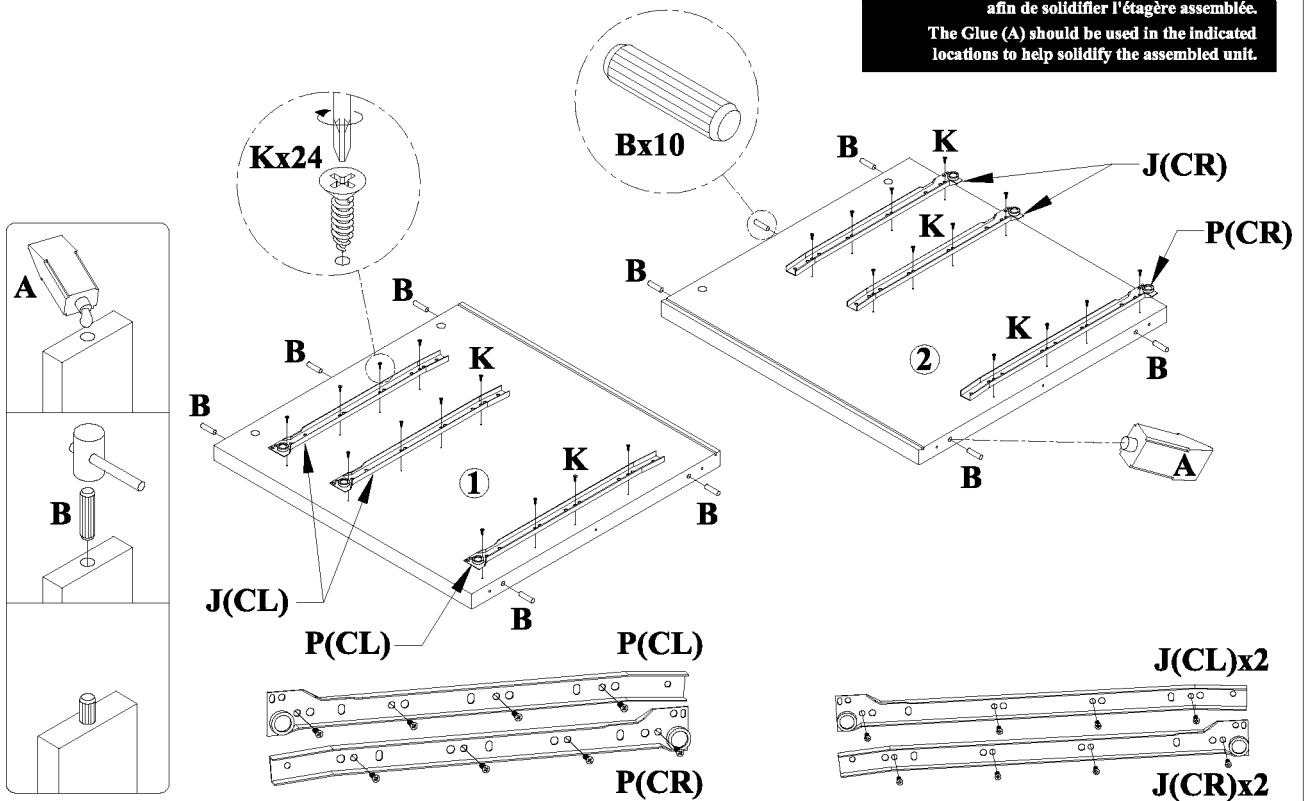

ÉTAPE / STEP 2

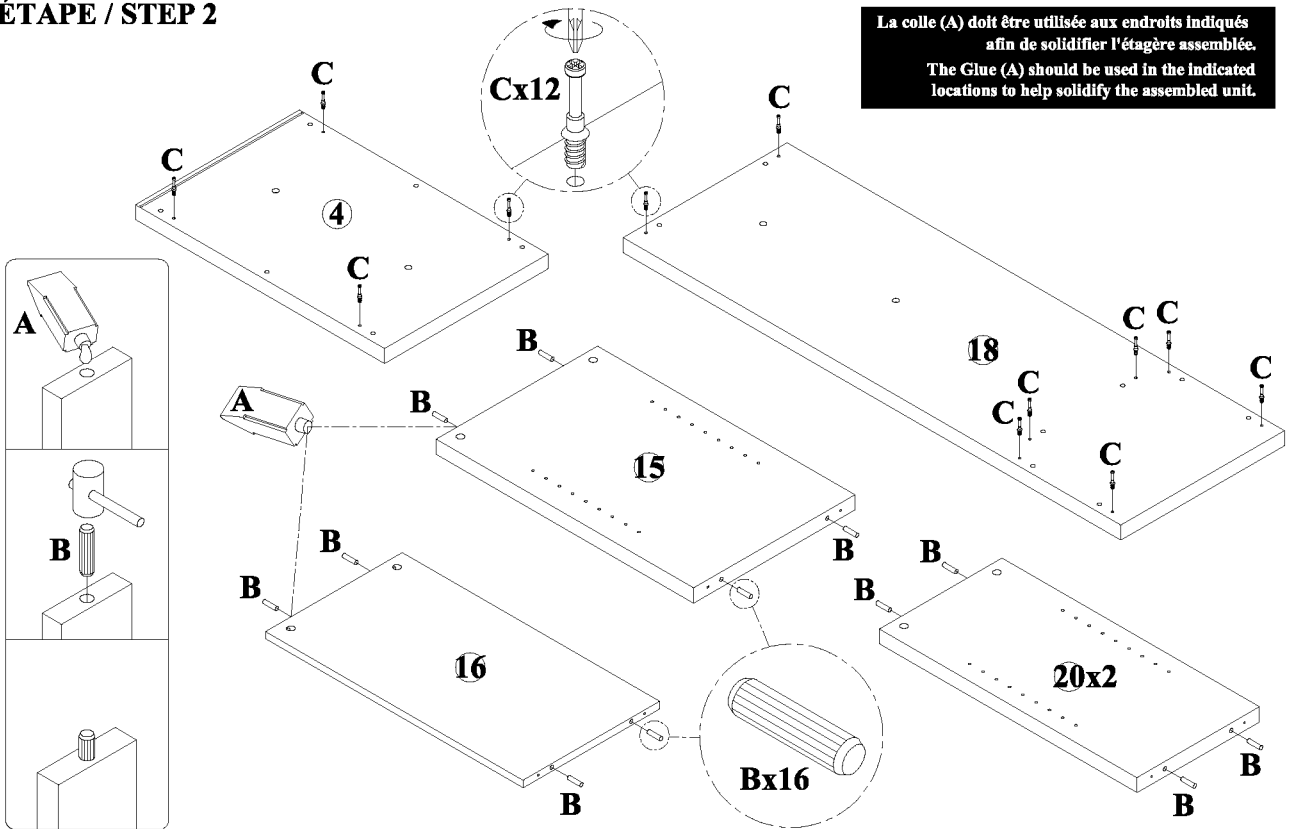

ÉTAPE / STEP 3

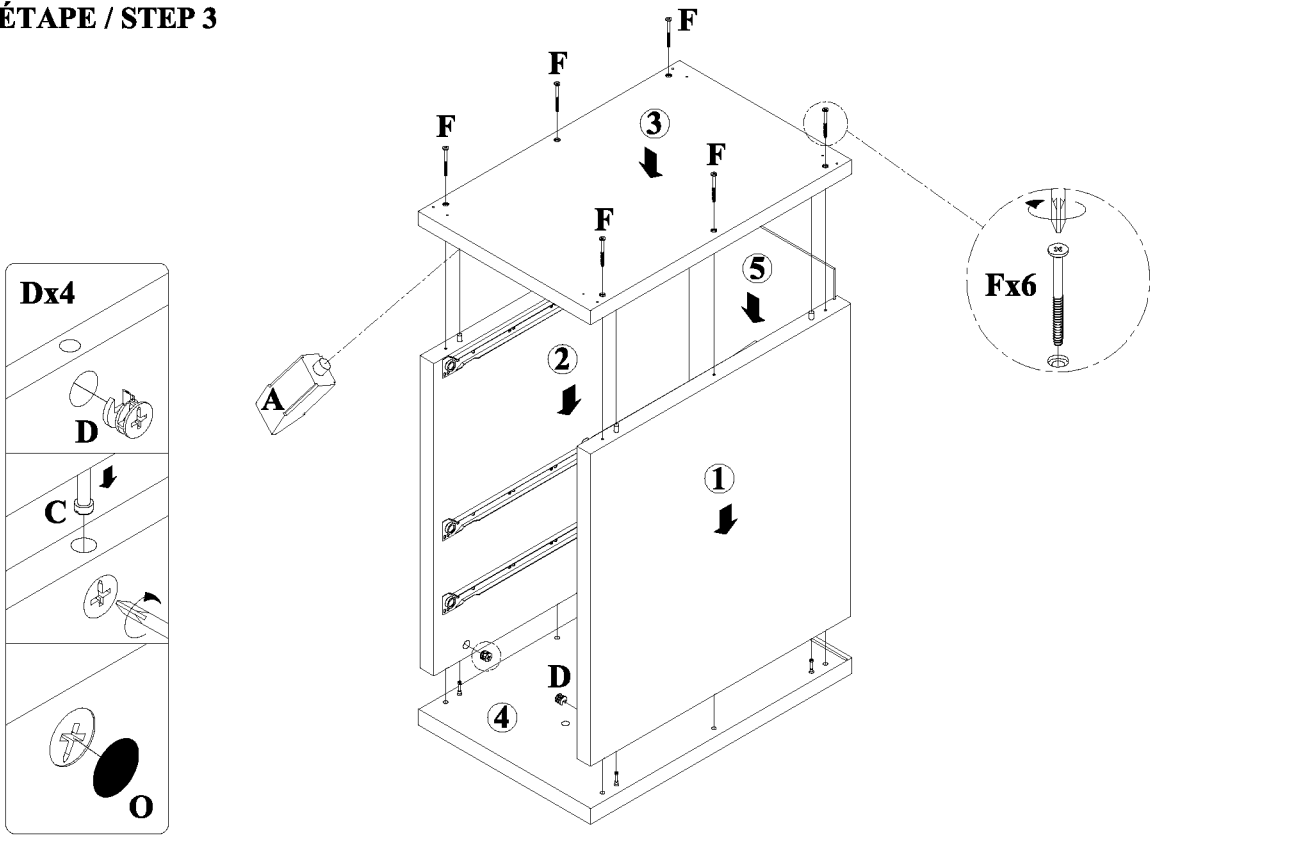

ÉTAPE / STEP 4

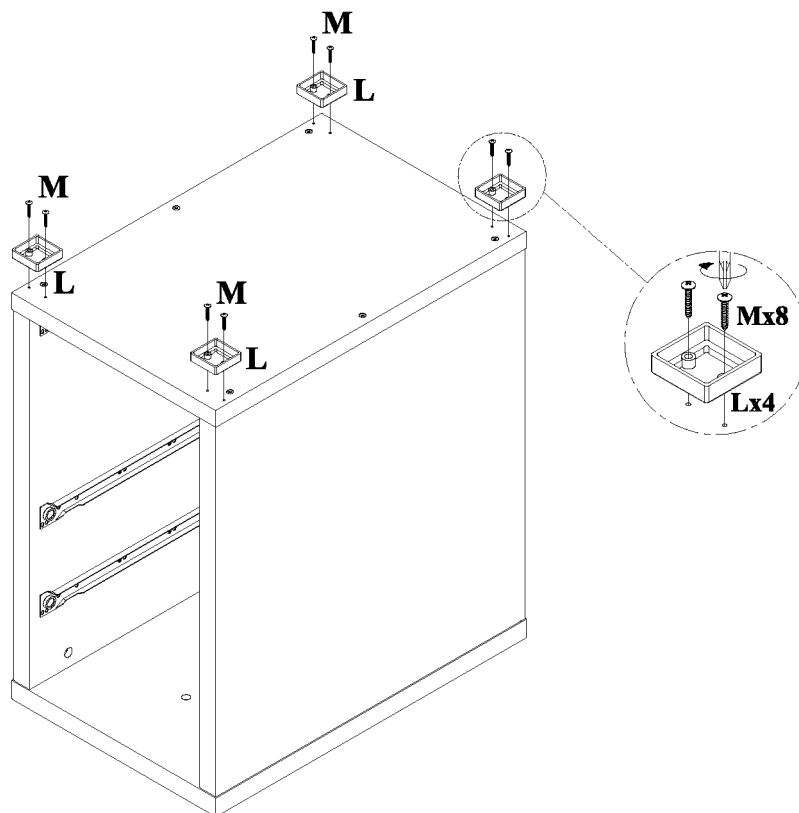

ÉTAPE / STEP 5

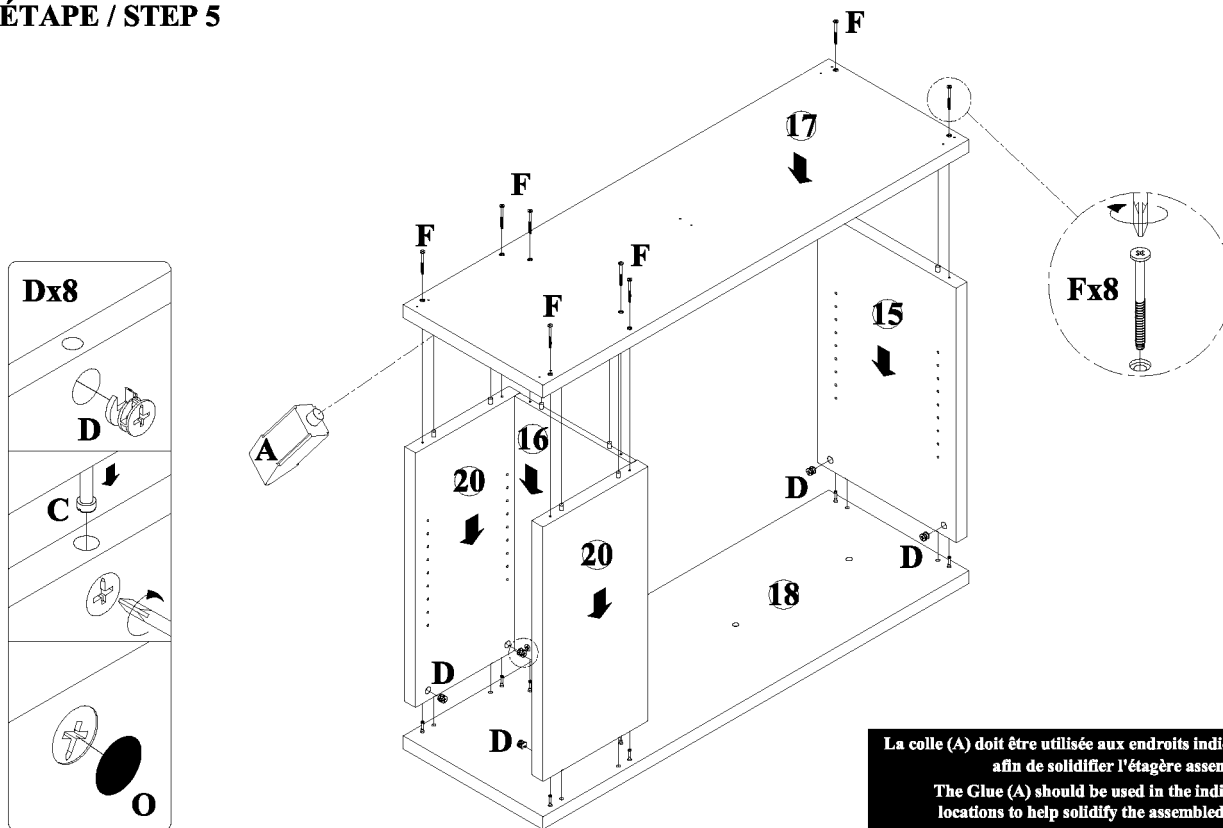

La colle (A) doit être utilisée aux endroits indiqués afin de solidifier l'étagère assemblée.
The Glue (A) should be used in the indicated locations to help solidify the assembled unit.

ÉTAPE / STEP 6

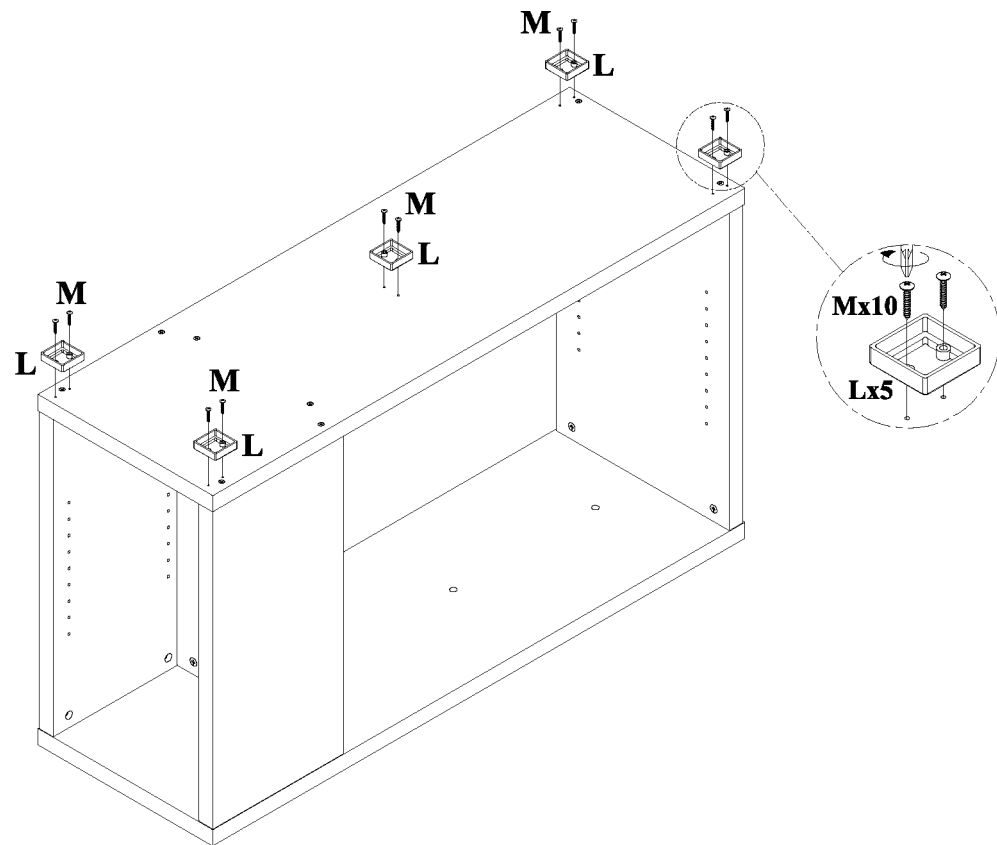

ÉTAPE / STEP 7

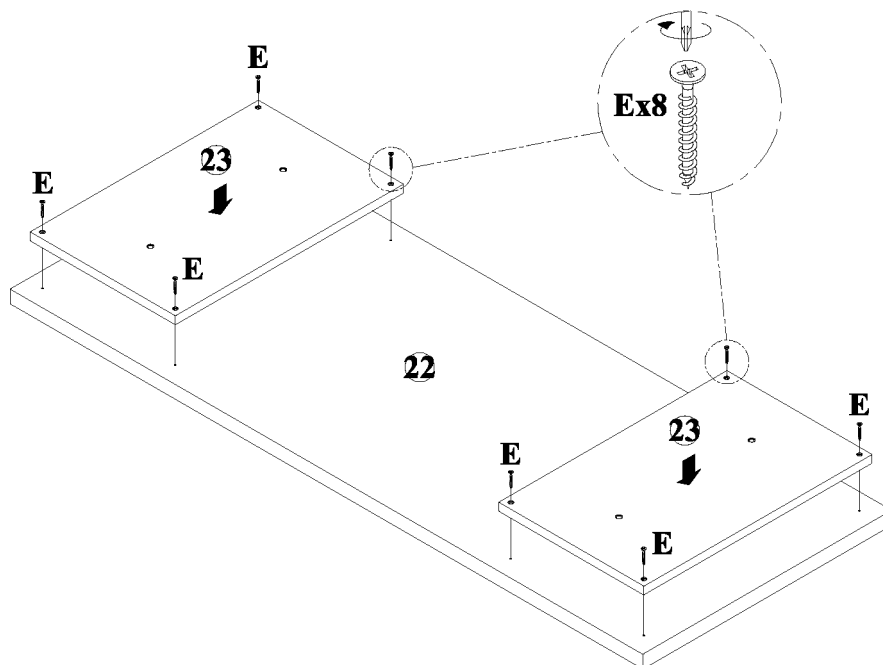

ÉTAPE / STEP 8

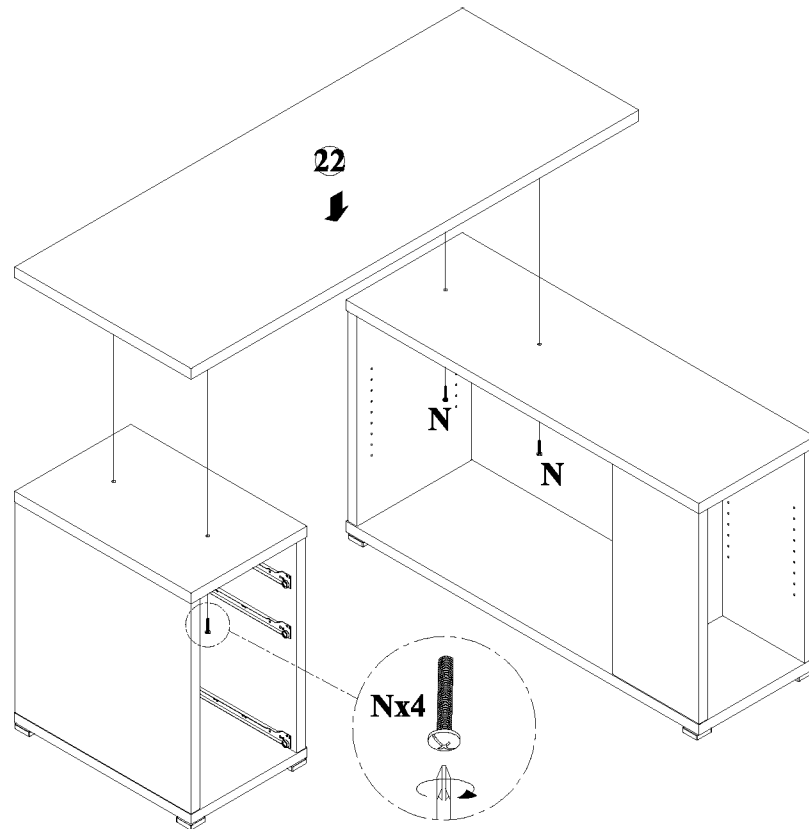

ÉTAPE / STEP 9

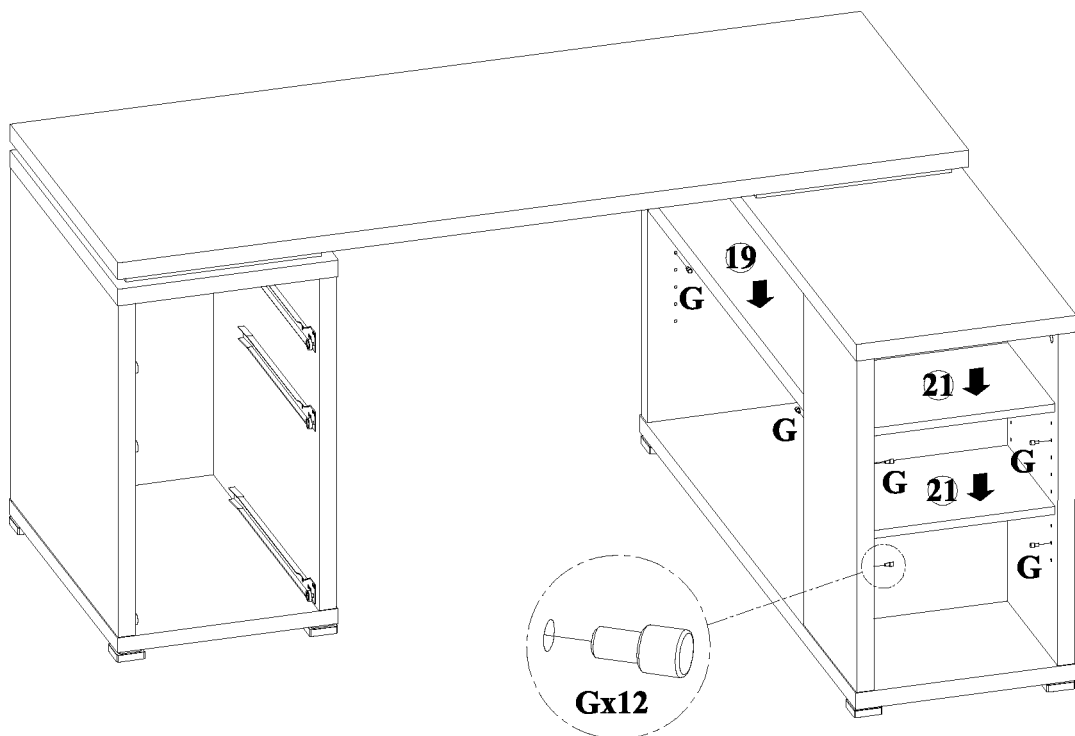

ÉTAPE / STEP 10

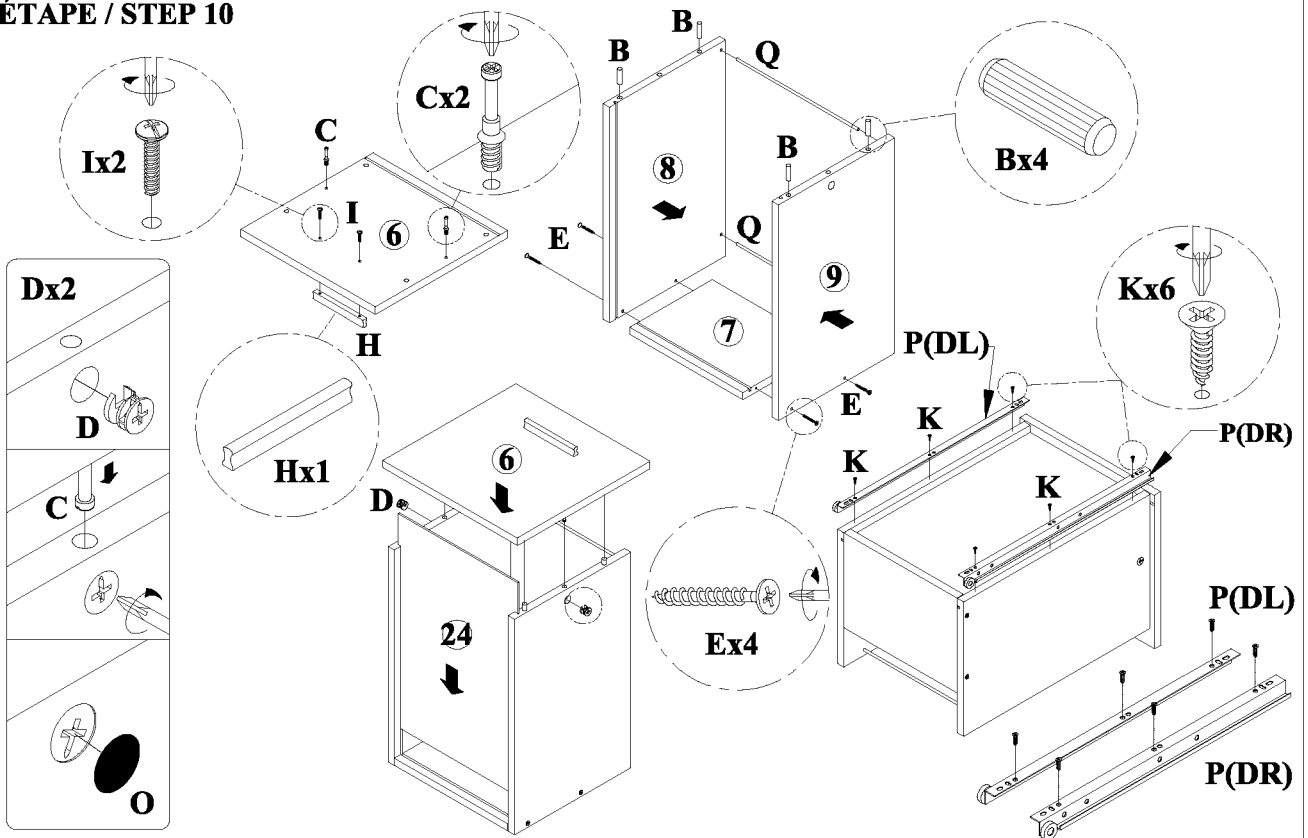

ÉTAPE / STEP 11

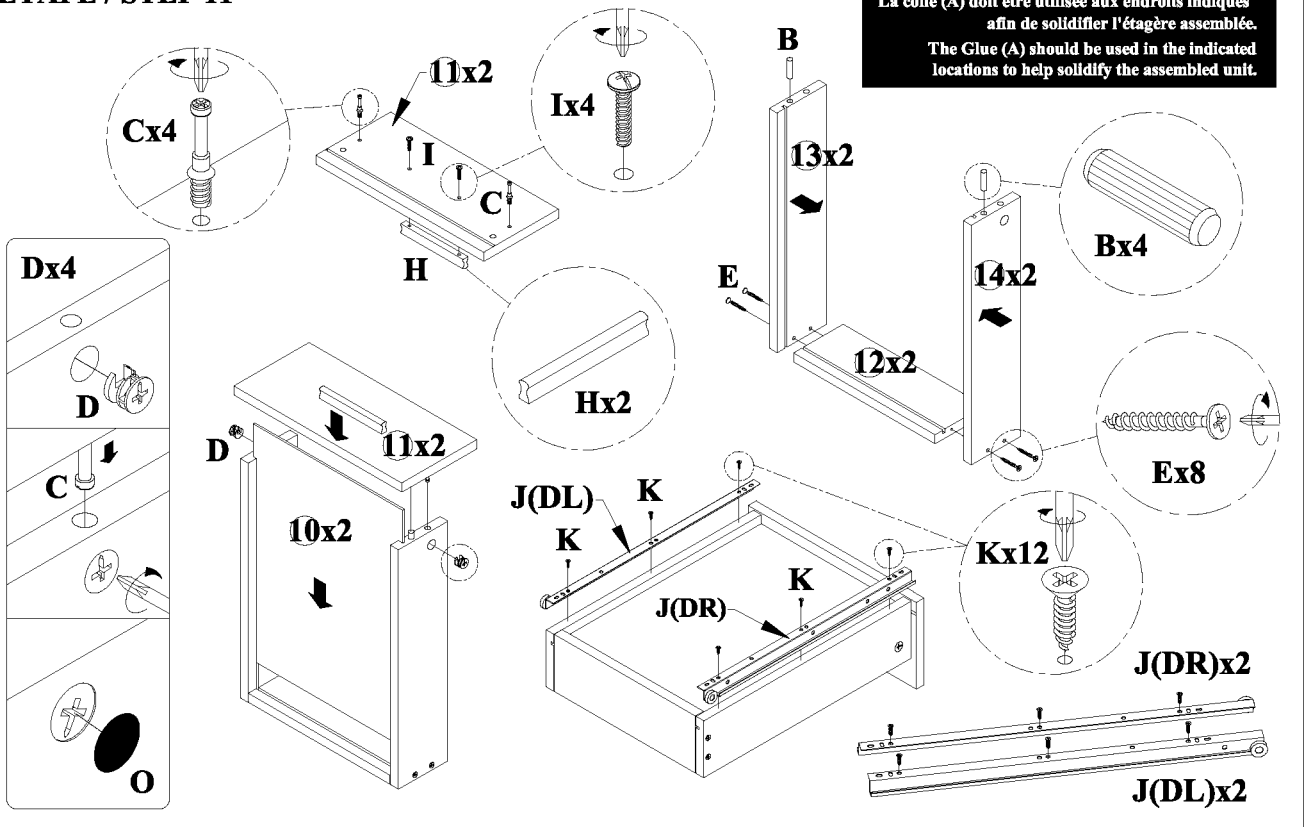

ÉTAPE / STEP 12

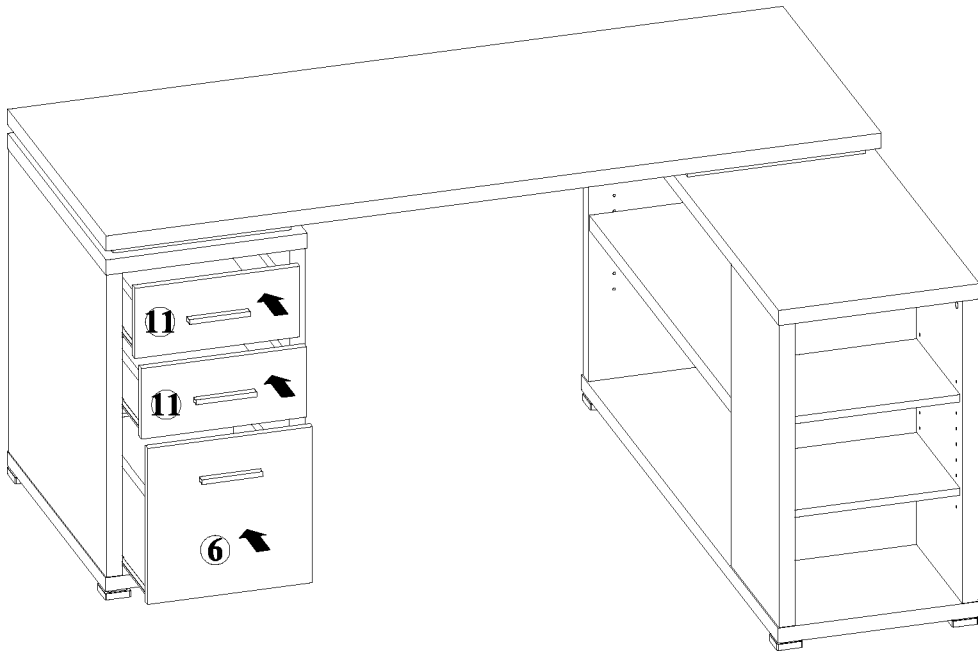

TERMINER / FINISH

