

Assembly Instruction

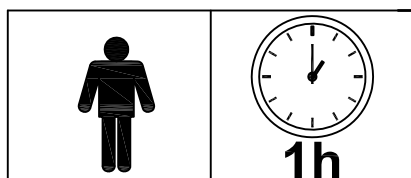

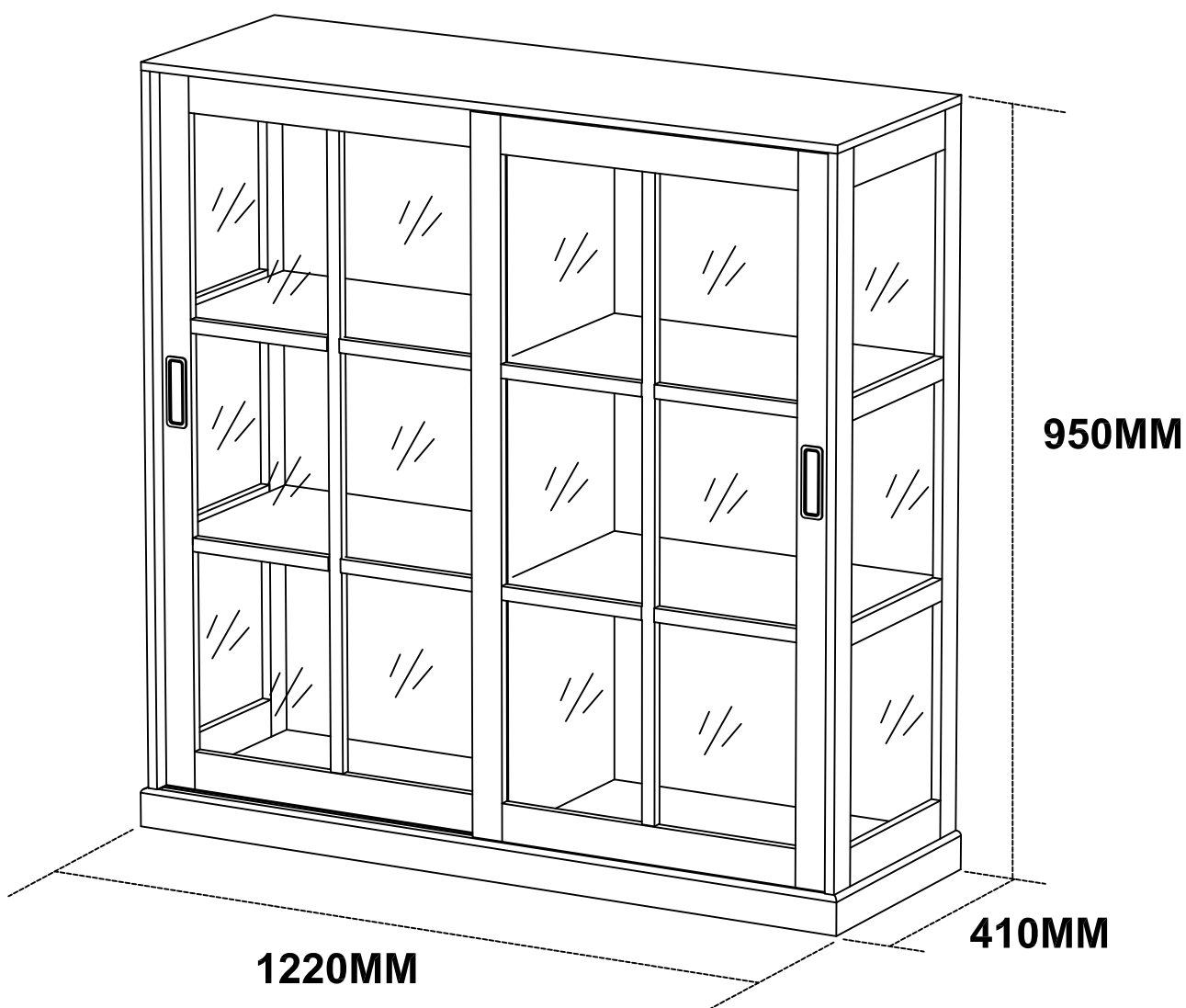
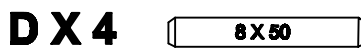
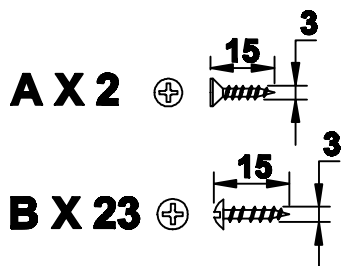
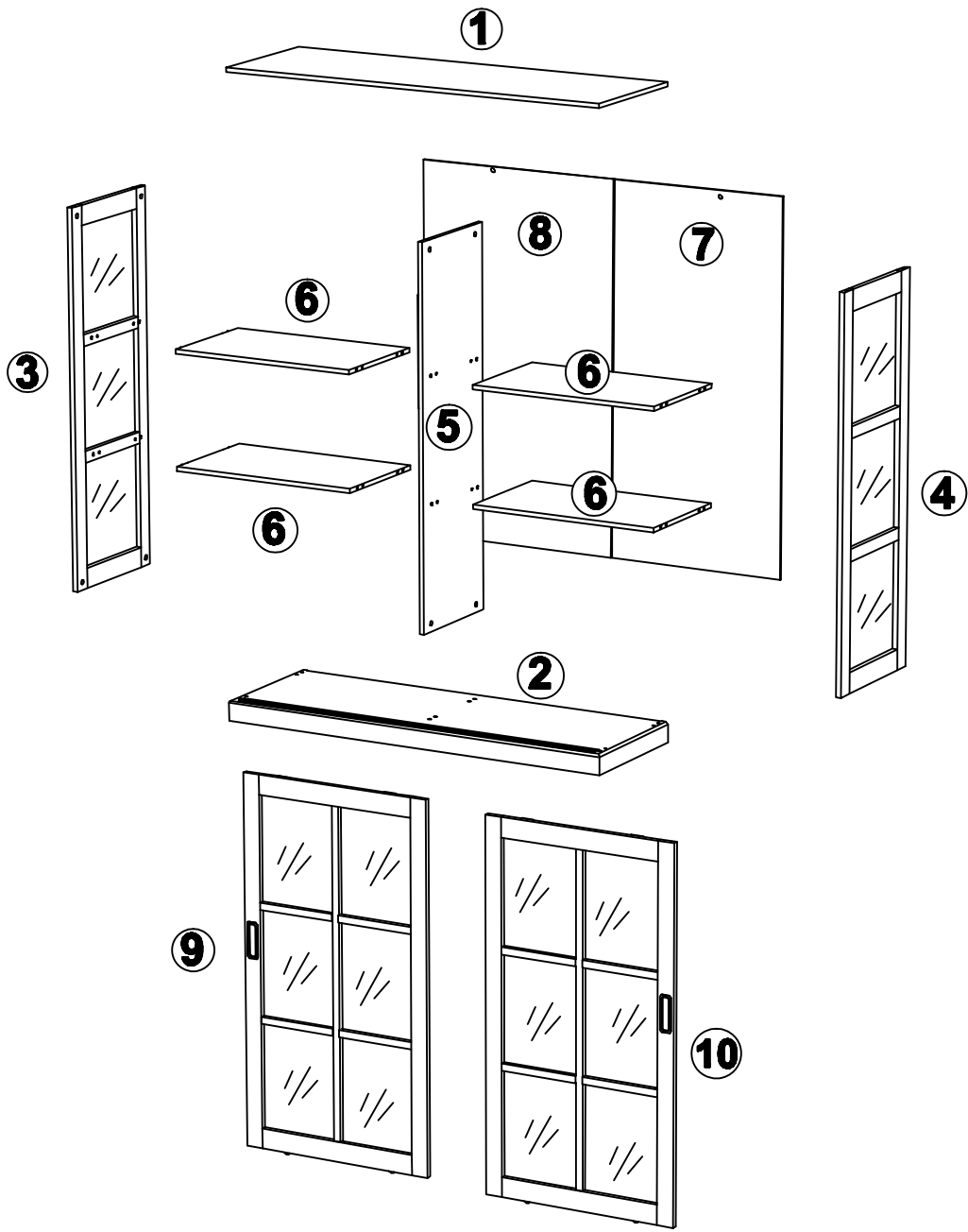

1

AX2 

HX2 

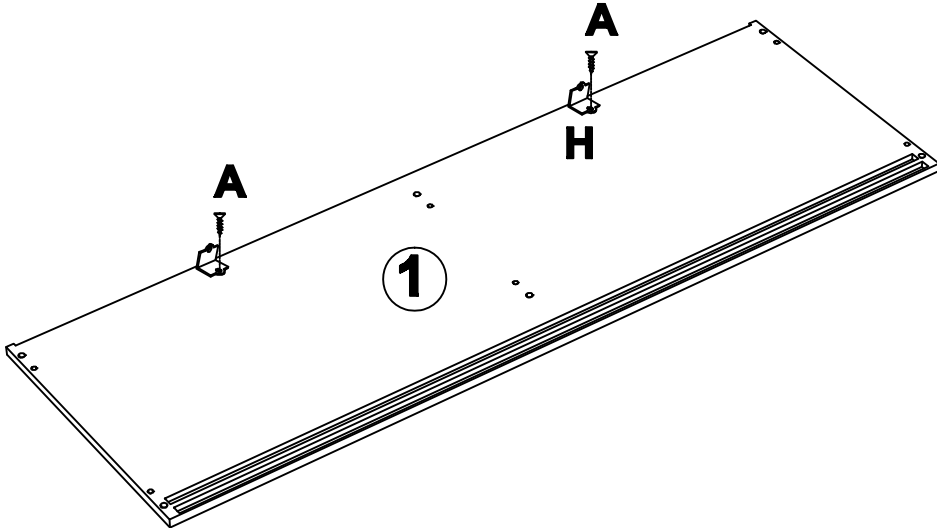

2

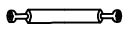
CX4 

DX4 

FX8 

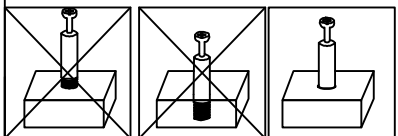
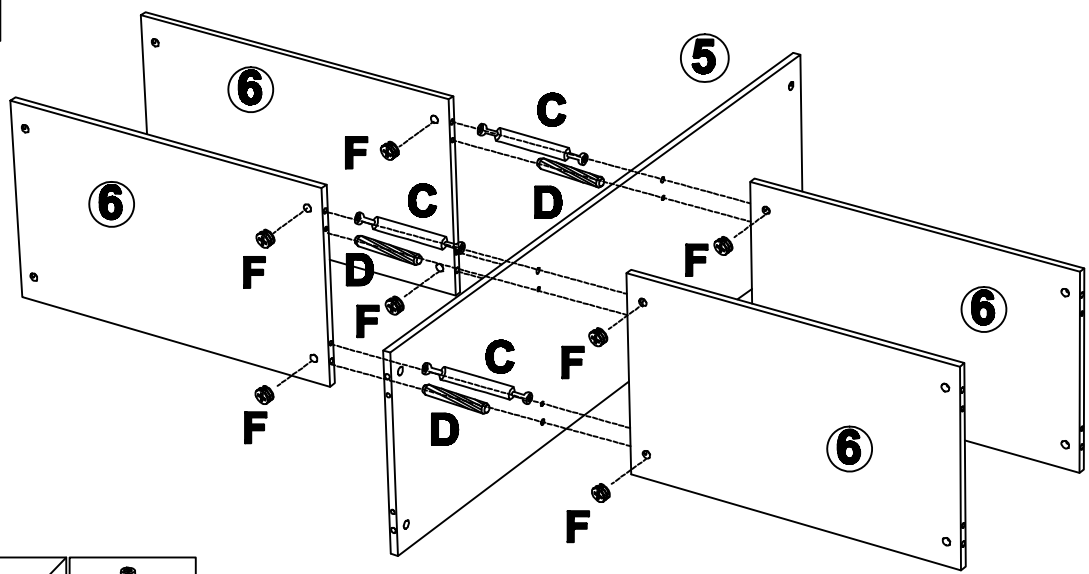

3

EX4 

FX4 

GX4  8X30

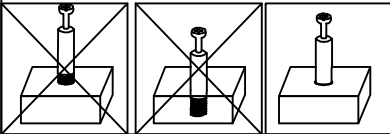
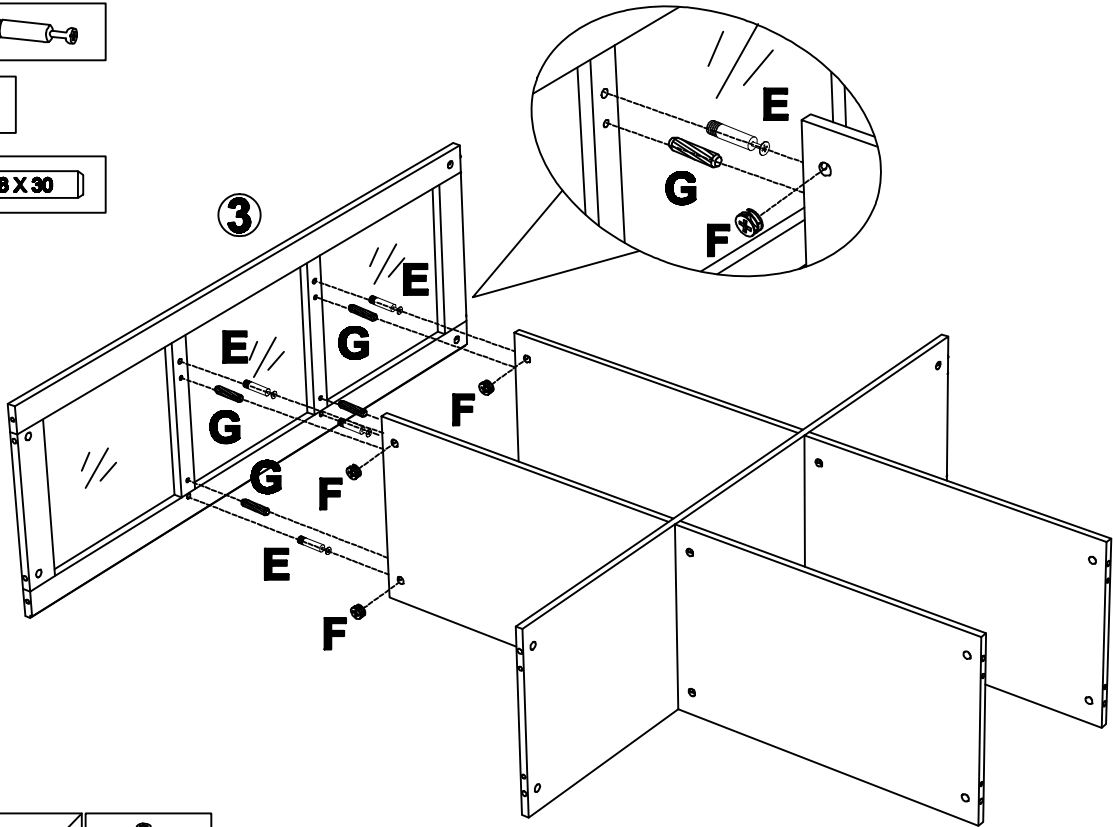

4

EX4 

FX4 

GX4  8X30

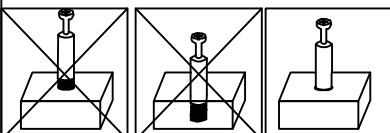
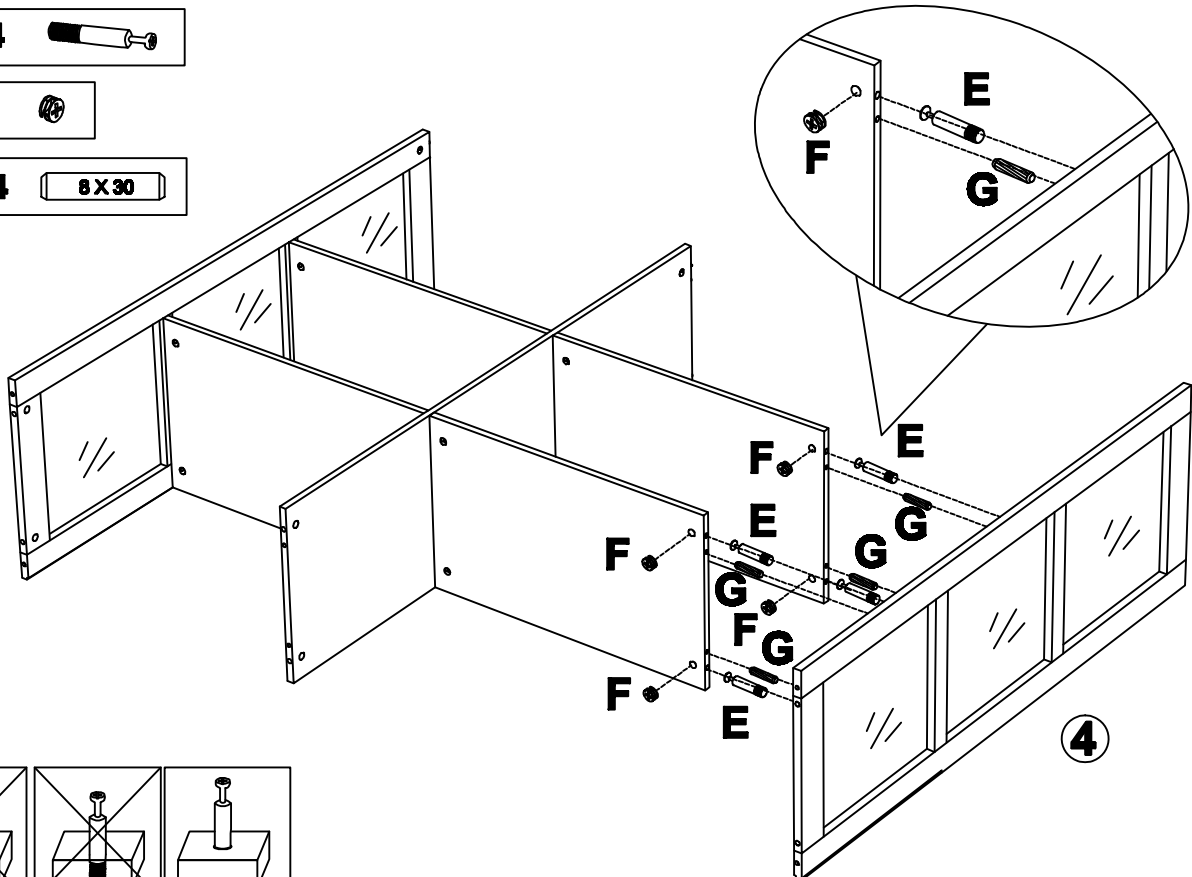

5

EX 6 

FX 6 

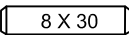
GX 6  8 X 30

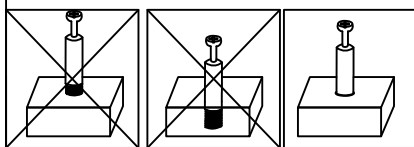
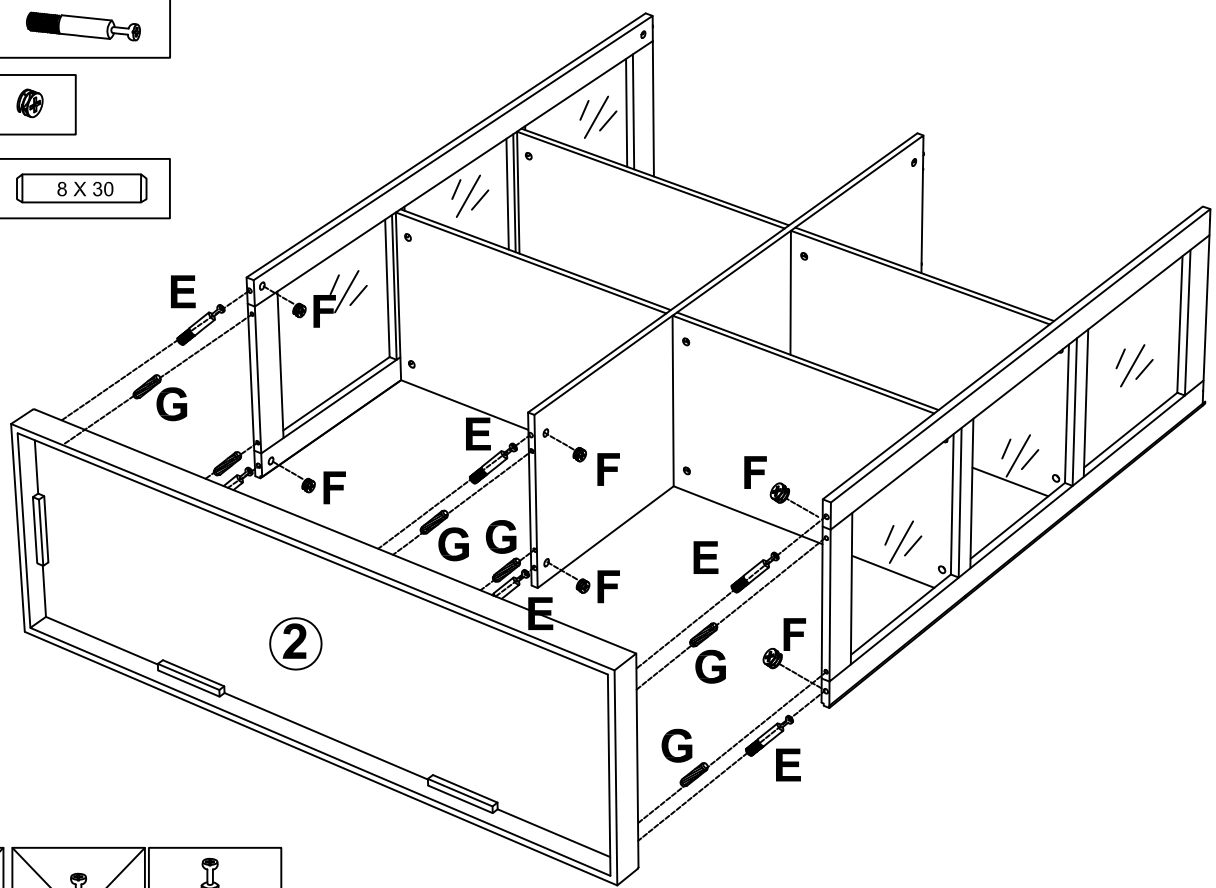

6

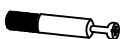

EX 6 

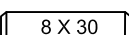
FX 6 

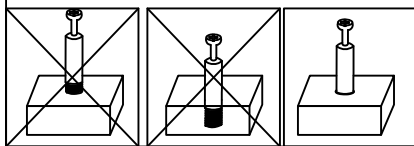
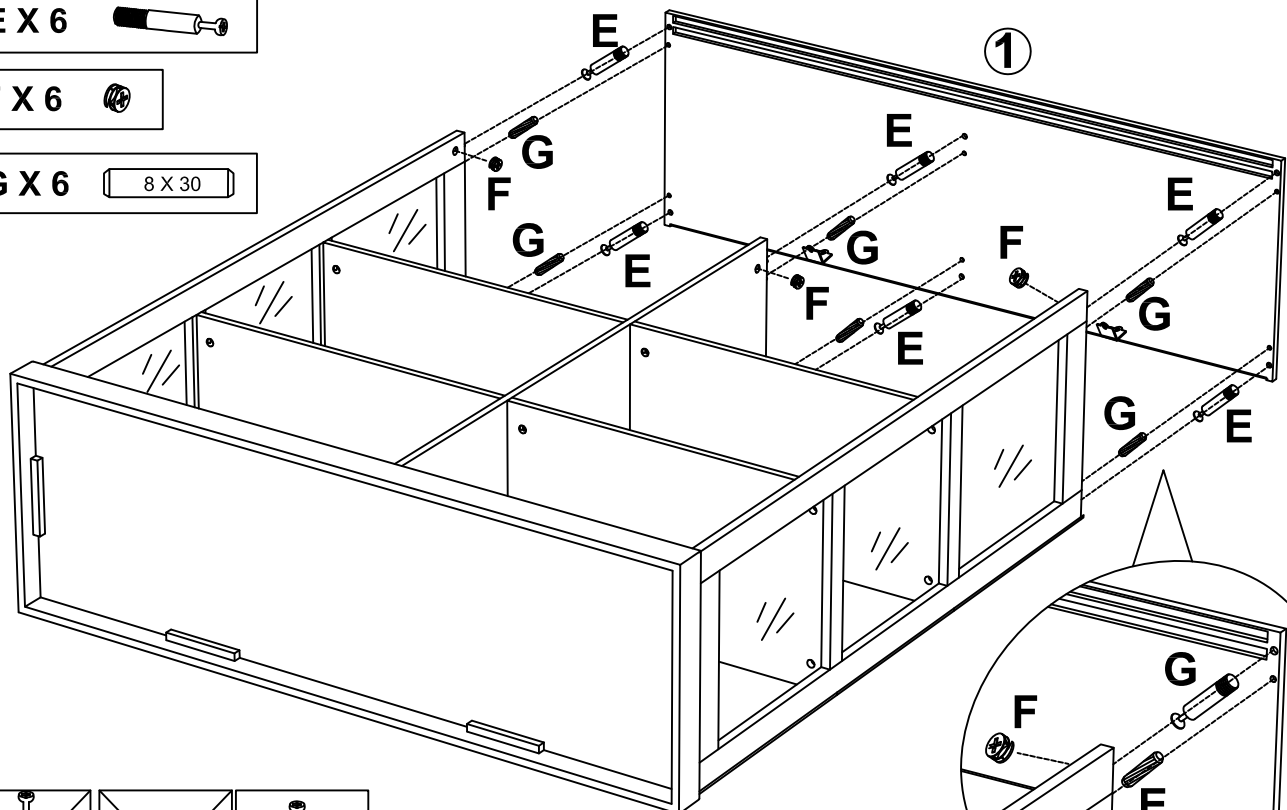
GX 6  8 X 30



7

B X 23  

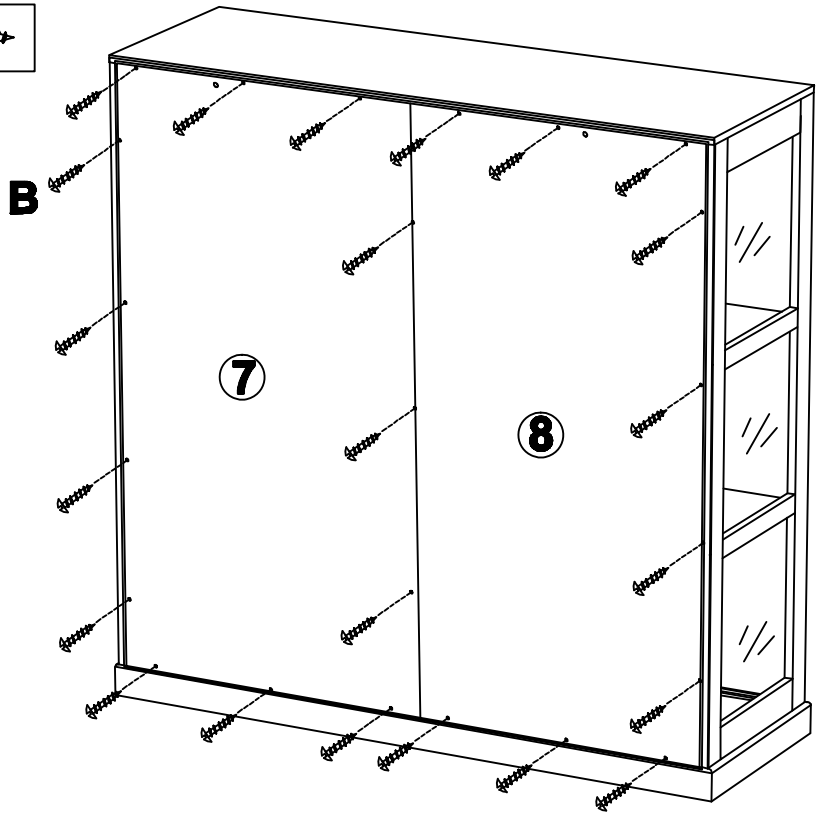

8

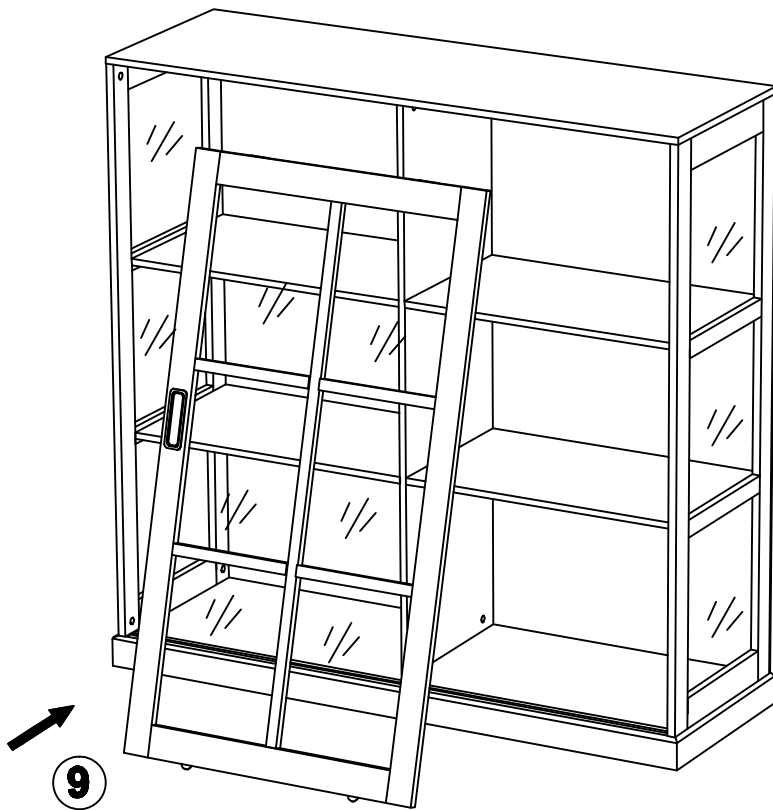

9

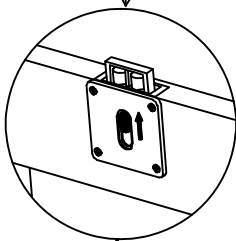
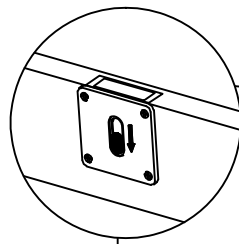

Please insert the door into the track of cabinet and push the button to make sure shrapnel will jumping out to catch the doors properly as well as moving smoothly

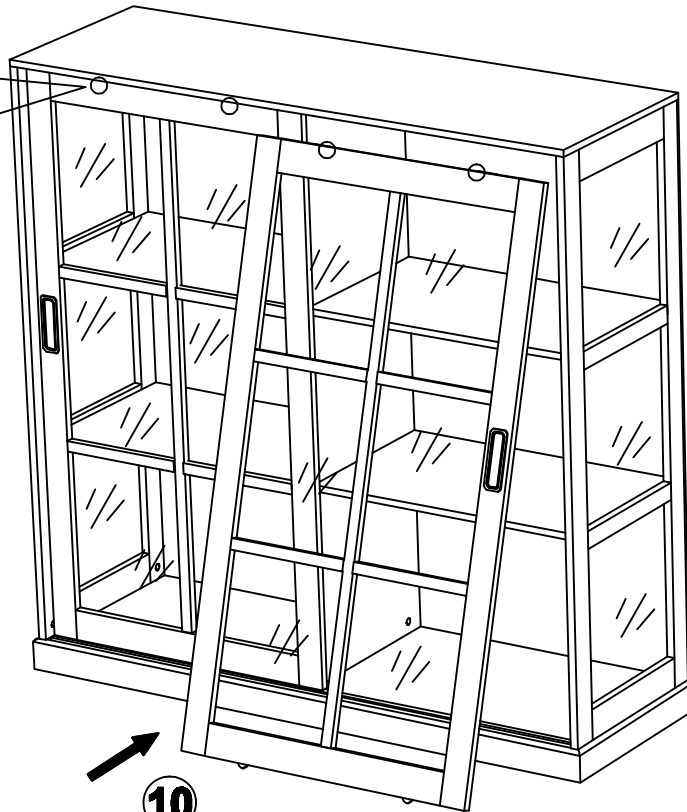

10

10

Adjustment screw for wheels up and down also keep the gap evenly between the door and cabinet it will give help on doors sliding smoothly , please work with Phillips screwdriver

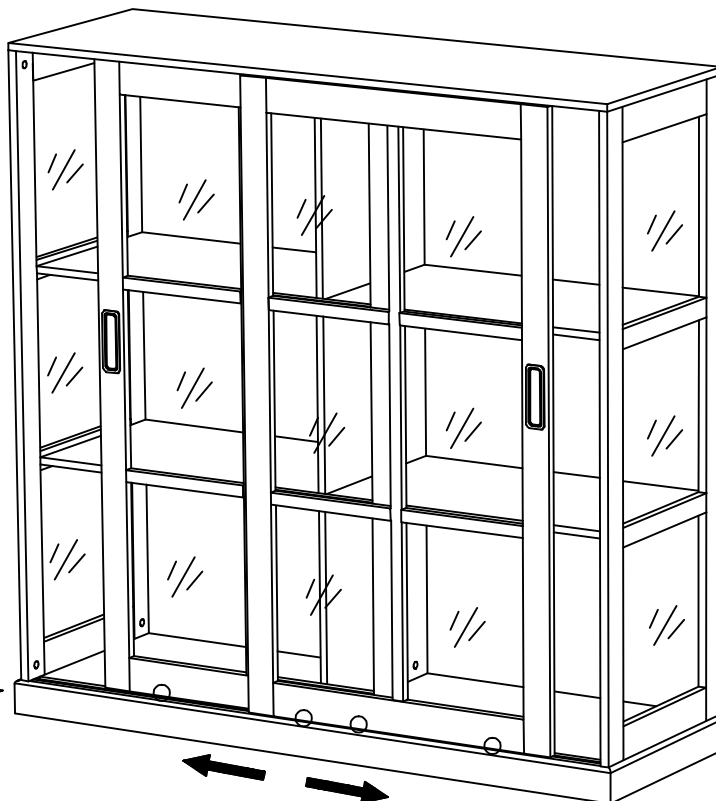
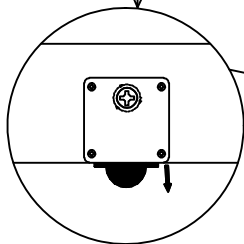
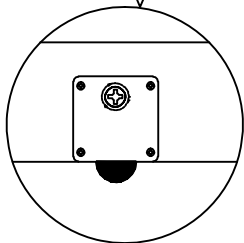

11

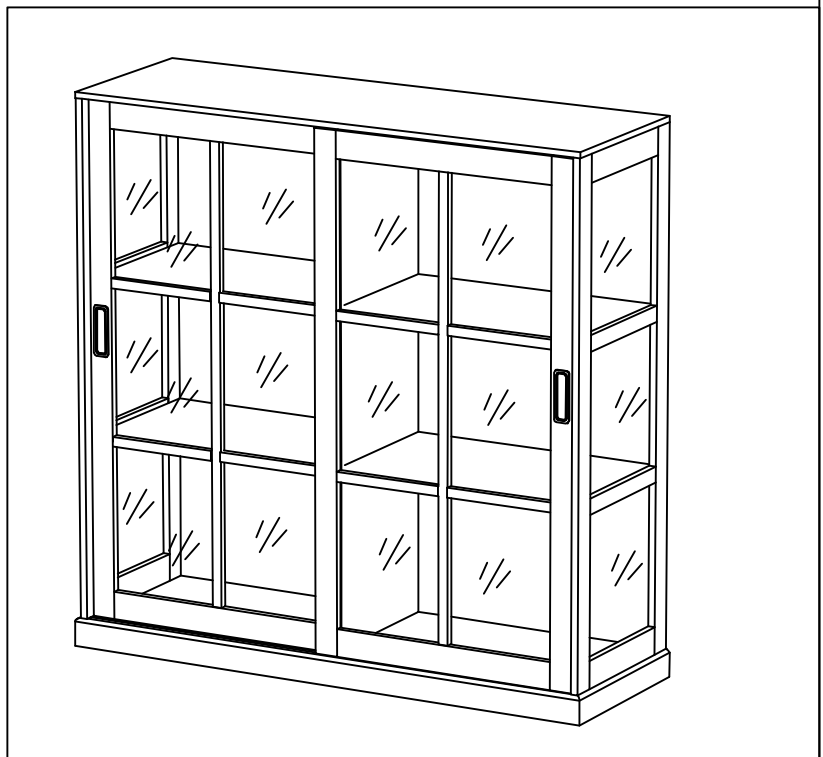
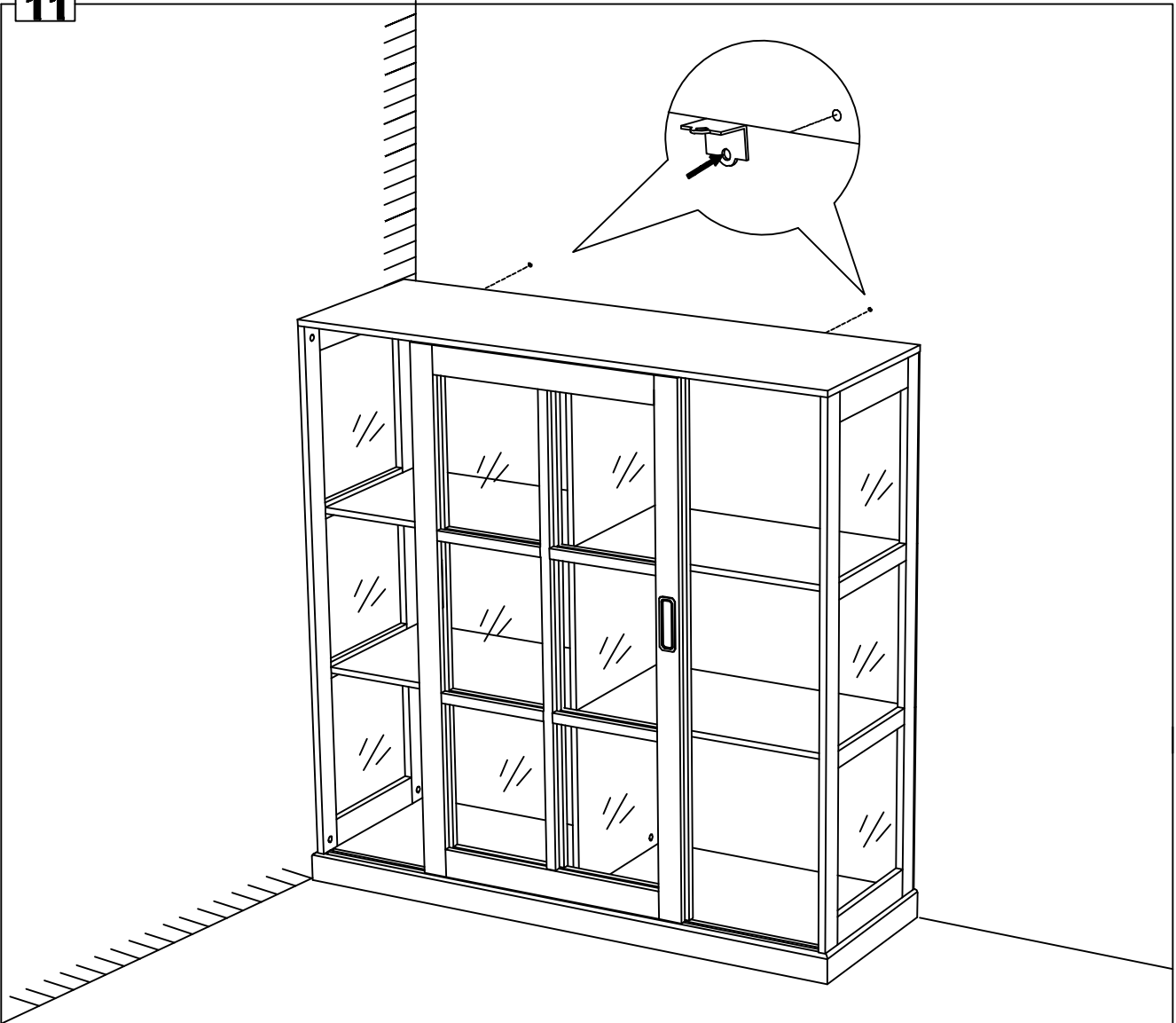



Il existe une grande diversité de types de murs ou cloisons, c'est la raison pour laquelle nous ne pouvons vous fournir le type exact de fixation. Il est nécessaire d'identifier le type de paroi à laquelle vous allez fixer ce produit afin de vous procurer les fixations appropriées. Voici quelques exemples de fixations conseillées pour :



LES MURS PLEINS

LES CLOISONS CREUSES

CHEVILLE NYLON "FISCHER"

CHEVILLE D'ANCRAGE MÉTAL

CHEVILLE D'ANCRAGE A AILETTES EN NYLON

CHEVILLE MÉTALLIQUE A EXPANSION

CHEVILLE "MOLLY"

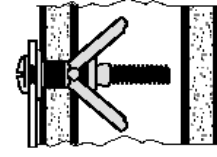
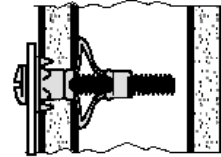
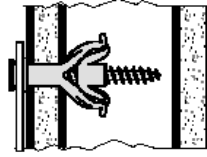
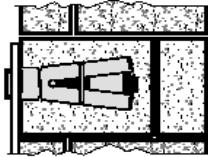
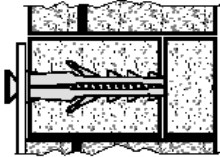
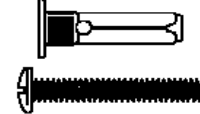
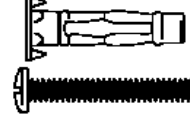
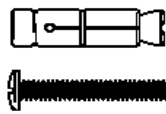
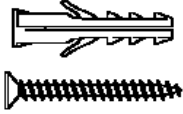

Utiliser une taille de forêt adaptée à la quincaillerie utilisée et au type de mur.



Due to the wide diversity of wall or partition types, we cannot provide you with suitable attachment fixtures. To determine which attachment fixtures to use, you will need to identify the type of wall to which you will be fixing this product. Here are some examples of attachment fixtures recommended for:



BLIND WALLS

STUDDED WALLS

"FISCHER" Nylon plug

Metal Wall plug

Nylon winged Wall plug

Metal expansion plug

"MOLLY"plug

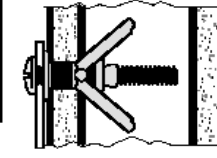
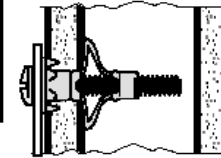
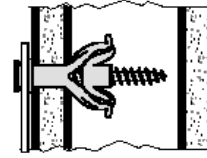
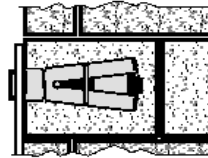
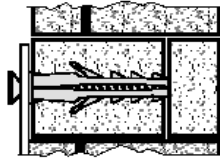
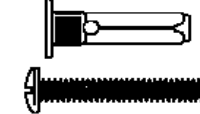
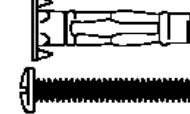
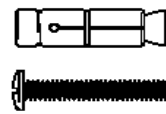
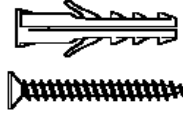

Use a drill bit that is compatible in size with the hardware used and the type of wall.



Esiste una gran varietà di tipi di muri o paratie e noi siamo in grado di fornirvi il tipo esatto di fissaggio per ognuno di essi. E' necessario identificare il tipo di parete alla quale intendete fissare questo prodotto in modo da fornirvi i fissaggi più idonei. Ecco qualche esempio di fissaggi consigliati per :



I MURI PIENI

**TASSELLO NYLON
"FISCHER"**

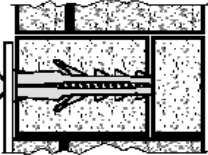
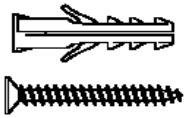

**TASSELLO DI
ANCORAGGIO IN
METALLO**

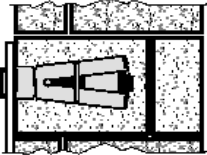
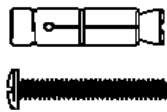

**TASSELLO DI
ANCORAGGIO AD
ALETTE IN NYLON**

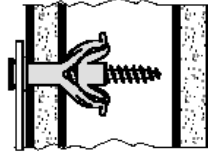
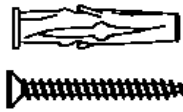

**PARATIE CAVE
TASSELLO METALLICO
AD ESPANSIONE**

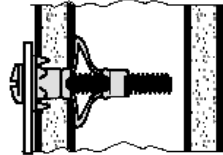
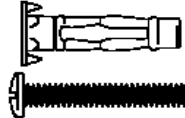

**TASSELLO
"MOLLY"**

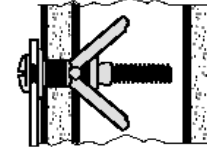
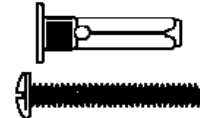

Utilizzare una punta di trapano adatta agli utensili utilizzati e al tipo di muro.



Es gibt eine Vielzahl verschiedener Arten von Mauern oder Zwischenwänden, und aus diesem Grunde können wir Ihnen den genau entsprechenden Befestigungstyp nicht bereitstellen. Zunächst ist es erforderlich, die exakte Bauart der Wand zu ermitteln, an der Sie dieses Produkt anbringen werden, um die für diese Wand geeigneten Befestigungsmittel im Fachhandel erwerben zu können. Nachfolgend einige Beispiele empfohlener Befestigungen für:



VOLLWÄNDE

**NYLONDÜBEL
„FISCHER“**

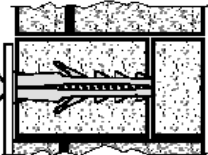
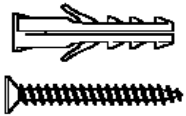

**ANKERDÜBEL
AUS METALL**

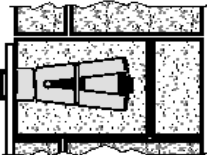
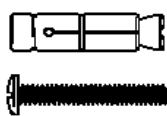

**ANKERDÜBEL MIT
NYLONFLÜGELN**

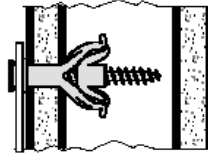
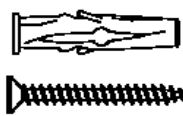

**HOHLWÄNDE
SPREIZDÜBEL FÜR
VERANKERUNG AUS METALL**

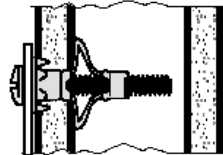
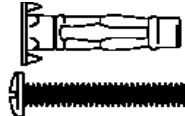

MOLLY-DÜBEL

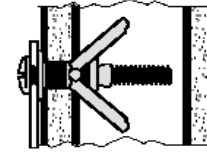
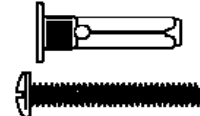

Bitte verwenden Sie eine für die Eisenwaren und den Wandtyp geeignete Bohrergröße.