

## UPHOLSTERY PLATFORM HEADBOARD

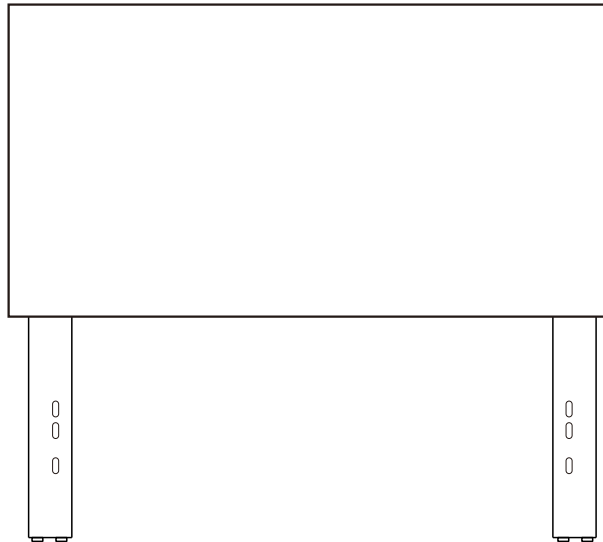

# CAUTION

### PLEASE DO NOT RETURN THIS ITEM TO STORE WHERE IT WAS PURCHASED

We appreciate your selection of our product. You can have confidence in this product that incorporates quality components. Please do not return this item to where it was purchased, if any question, please contact our Customer Service Department



## Upholstered furniture care instructions

- Vacuum your upholstered furniture regularly. Small dust particles are very abrasive and can wear furniture prematurely.
- Blot spills immediately to prevent staining. If necessary, gently wipe away the spill using a soft, clean cloth dampened with lukewarm water. Allow to dry and brush lightly.
- Never use harsh chemicals or solvents on your upholstered furniture as this may damage the fabric.
- Never use water to clean your furniture as it may cause damage to the finish.
- If you choose to use a professional product, pretest the fabric in an inconspicuous area for any signs of discoloration or shrinking.
- Marks and stains from pens, crayons and ink markers are difficult to remove. In the event that your furniture becomes permanently stained, we recommend that you consult a professional.

## Quality statement



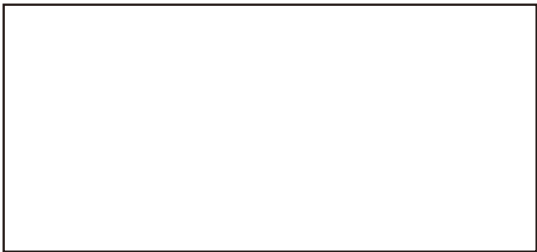

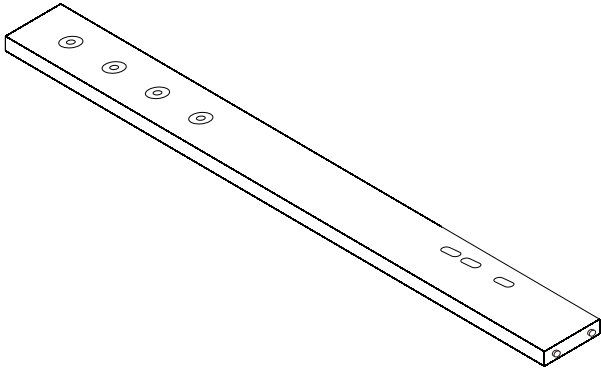
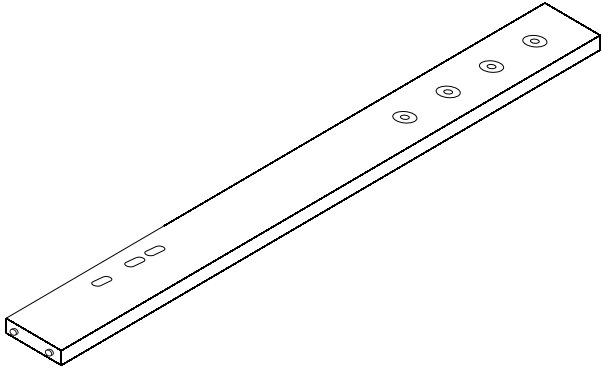
## PART LIST

PLEASE ALWAYS CHECK EVERY PART BEFORE YOUR ASSEMBLY

A	1PCE	B	1PCE
Headboard Panel		Non-woven cover	
			
L	1PCE	R	1PCE
Left Leg		Right Leg	
			

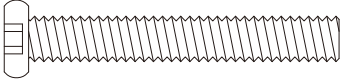
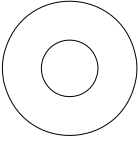
# PART LIST

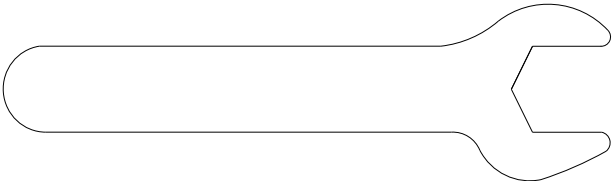
PLEASE ALWAYS CHECK EVERY PART BEFORE YOUR ASSEMBLY

①	8PCS	②	12PCS
Ø 1/4"x45mm Allen Bolts		Flat Washers	
			
③	8PCS	④	4PCS
Spring Washers		Nuts 1/4	
			
⑤	1PCE	⑥	1PCE
Nut wrench		Allen Wrench 1/4	
			

**Step 1:**  
**Pick out Left Leg & Right Leg (L/R) hardware and non-wover cover (B) from Headboard Panel(A) back.**

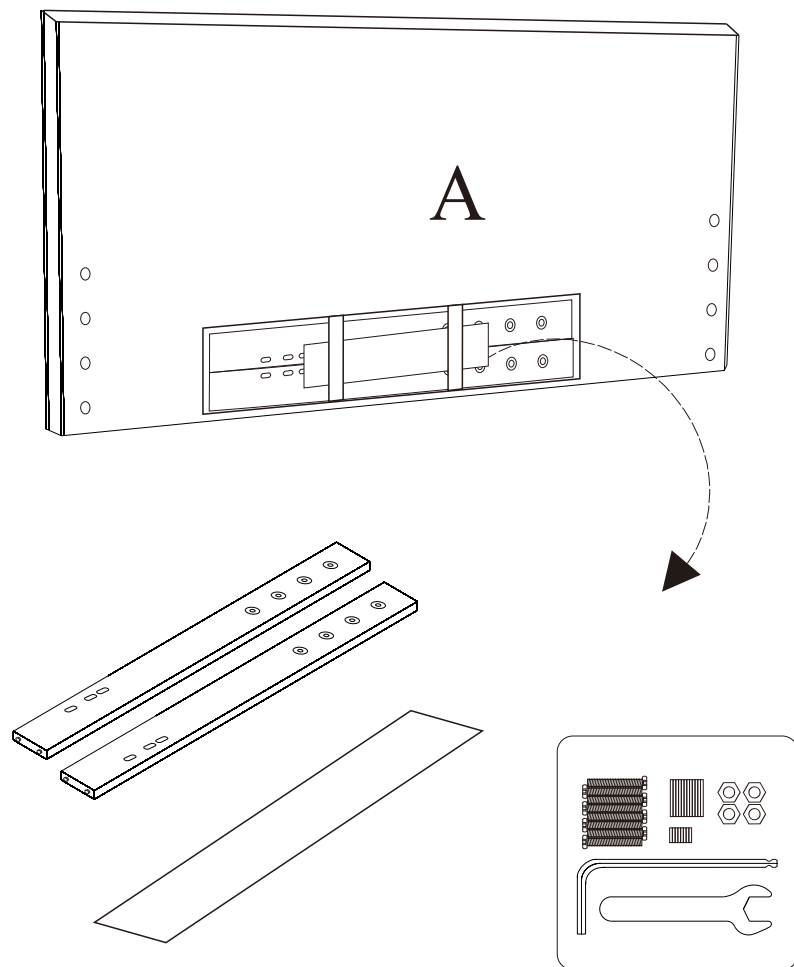

**Step 2:**

**Attach non-woven cover (B) to Headboard Panel(A) back.**

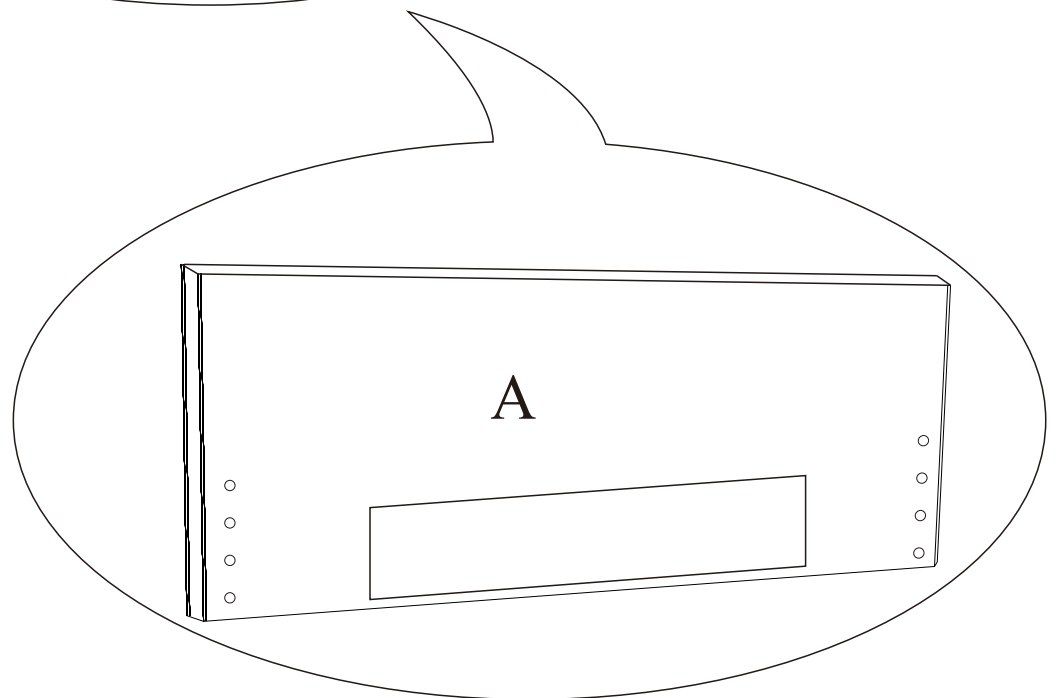
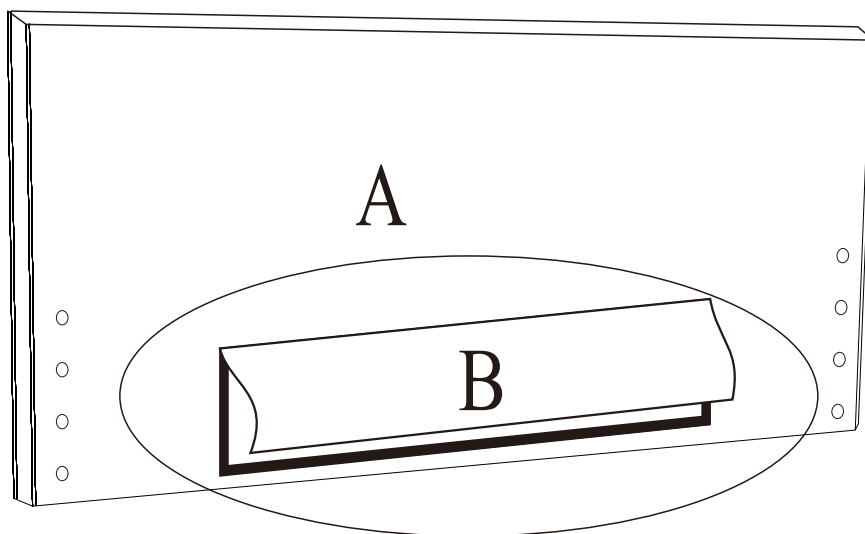

## IMPORTANT!!

\*\*For making the entire unit assemble straightly, do not roll screws too tight when first secure the screw 80% is fine, after finish all screws, secure them completely and tightly.

\*\*Please also check your thickness of mattress and box spring before your assemble.

### Step 3:



### Fasten the Leg (L & R) and Headboard(A).

### IMPORTANT!

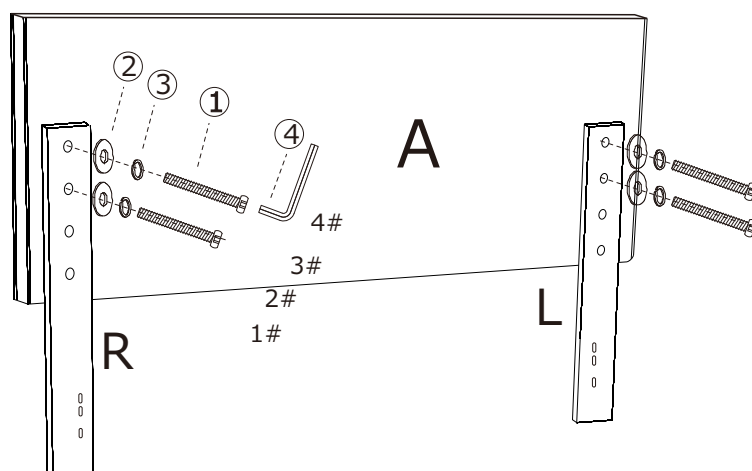
Please check your box spring and / or mattress thickness before your assembly.



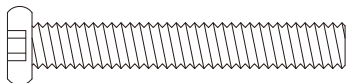
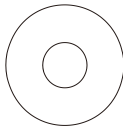
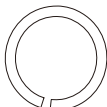

Box Spring + Mattress	Adjustable Headboard Height
Under 10"	T match 4#
10"~14"	T match 3#
14"~18"	T match 2#
18"	T match 1#

①	4PCS	②	4PCS
Ø 1/4"x45mm Allen Bolts		Flat Washers	
			
③	4PCS	④	1PCE
Spring Washers		Allen Wrench 1/4	
			

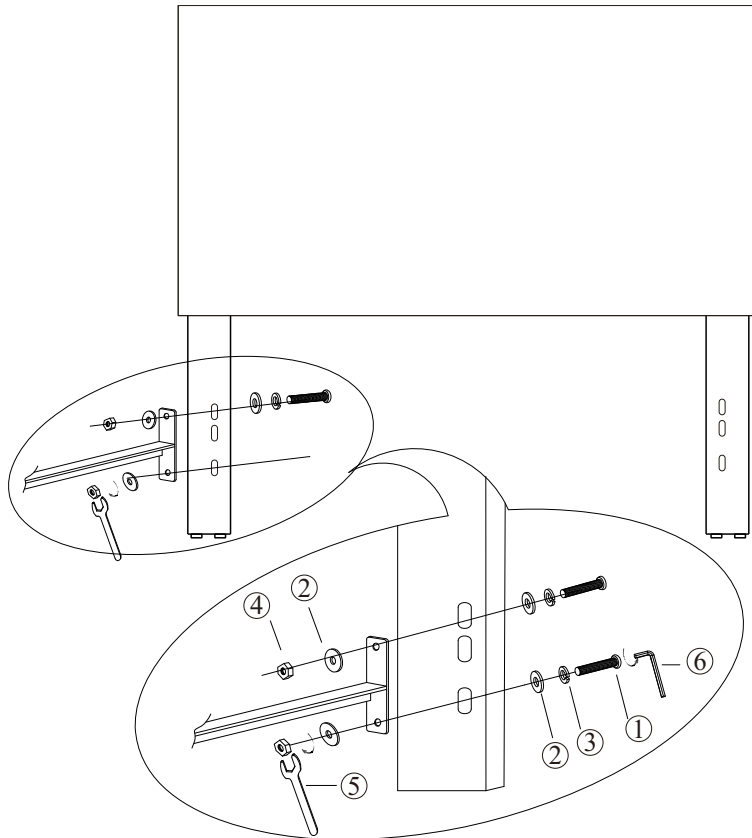
**Attach the metal bed frame (not included) to headboard Legs (L&R).**

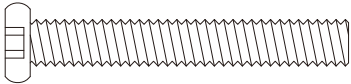
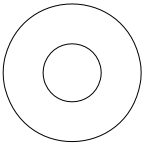

①	4PCS	②	8PCS	③	4PCS
Ø 1/4"x45mm Allen Bolts		Flat Washers		Spring Washers	
					
④	4PCS	⑤	1PCE	⑥	1PCE
Nuts 1/4		Nut wrench		Allen Wrench 1/4	
