

Built-in Electric Oven

KQC65C-17

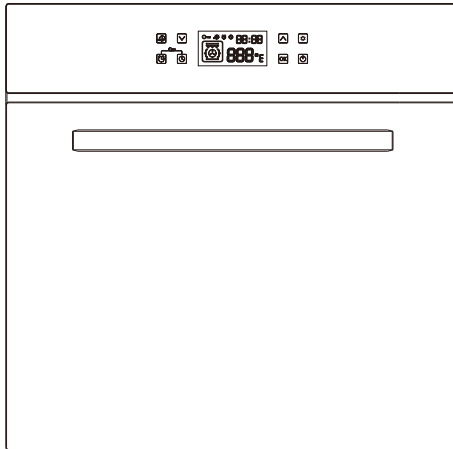

DEAR CUSTOMER,

The oven is exceptionally easy to use and extremely efficient. After reading the instruction manual, operating the oven will be easy.

Before being packaged and leaving the manufacturer, the oven was thoroughly checked with regard to safety and functionality.

Before using the appliance, please read the instruction manual carefully. By following these instructions carefully you will be able to avoid any problems in using the appliance.

It is important to keep the instruction manual and store it in a safe place so that it can be consulted at any time. It is necessary to follow the instructions in the manual carefully in order to avoid possible accidents.

Caution!

Do not use the oven until you have read this instruction manual.

The oven is intended for household use only.

The manufacturer reserves the right to introduce changes which do not affect the operation of the appliance.

TABLE OF CONTENTS

| | |
|-----------------------------------|----|
| Safety instructions | 3 |
| Description of the appliance..... | 8 |
| Installation | 10 |
| Operation..... | 13 |
| Cleaning and maintenance..... | 17 |
| Technical data..... | 20 |

SAFETY INSTRUCTIONS

NOTE:

Ensure there is a grounded socket nearby (behind the unit)

A dedicated power circuit is recommended for the unit but not required. Additional electrical appliances on the same circuit may exceed the current (amperage) rating for that circuit. If after the installation of your unit, the circuit breaker trips or the fuse fails on a repeated basis, then a dedicated circuit will likely be required.

! The appliance must be installed only by a qualified person in compliance with the instructions provided. Incorrect installation may cause harm to persons, animals or may damage property.

The manufacturer declines all responsibility for improper installation which may harm persons and animals and damage property.

Important: The power supply to the appliance must be cut off before any adjustments or maintenance work is done on it.

WARNING:

When using this product, basic precautions should always be taken, including the following:

Your buliding-in oven is a classified electrical appliance. As with any electrical appliance and particularly with electric heaters, basic precautions must be followed in order to reduce the risk of fire, burns, electrical shocks and/or other serious injuries or death.

! The appliance becomes hot during operation. Take care not to touch the hot parts inside the oven.

! Always keep children away from the cooker.

While in operation direct contact with the cooker may cause burns!

! Ensure that small items of household equipment, including connection leads, do not touch the hot oven or the hob as the insulation material of this equipment is usually not resistant to high temperatures.

! Do not leave the cooker unattended when frying. Oils and fats may catch fire due to overheating or boiling over.

Do not put pans weighing over 15 Kg on the opened door of the oven and pans over 25 kg on the hob.

! Do not use harsh cleaning agents or sharp metal objects to clean the door as they can scratch the surface, which could then result in the glass cracking.

! Do not use the cooker in the event of a technical fault. Any faults must be fixed by an appropriately qualified and authorised person.

! In the event of any incident caused by a technical fault, disconnect the power and report the fault to the service centre to be repaired.

! The rules and provisions contained in this instruction manual should be strictly observed. Do not allow anybody who is not familiar with the contents of this instruction manual to operate the cooker.

! The cooker should not be cleaned using steam cleaning equipment.

SAFETY INSTRUCTIONS

- ! The panels adjacent to the oven must be made of heat-resistant material.
- ! Cabinets with a veneer exterior must be assembled with glues which can withstand temperature of up to 100°C.
- ! Keep combustible materials, such as: curtains, drapes, furniture, pillows, clothing, linens, bedding, paper, etc. , at least 3 feet(0.9 meters) from the front sides and rear of the heater. Do not use this unit in areas where gasoline, paint or other flammable liquids or their associated vapors may be present.
- ! To reduce the risk of fire, do not place or install this unit in areas where the ventilation or circulation ducts may become blocked.
- ! The unit's power cord must be connected to a properly grounded and protected, 220-240V electrical outlet. Always use ground fault protection where required by the electrical code. To reduce the risk of fire, avoid running the power cord under rugs, carpets, etc. Keep the power cord away from high traffic areas where it may pose a tripping hazard.
- ! Avoid the use of an extension cord, which may overheat and cause a fire.
- ! When transporting or storing the unit, keep it in a dry location, free from dust, excessive vibration or other factors, which may damage the unit.
- ! Do not operate any oven with a damaged cord or plug or after the heater malfunctions, has been dropped or damaged in any manner. Return oven to authorized service facility for examination, electrical or mechanical adjustment, or repaired.
- ! If the supply cord is damaged, it must be replaced by a special cord or assembly available from the manufacturer or its service agent.
- ! Use this oven only as described in this manual. Any other use not recommended by the manufacturer may cause fire, electric shock, or injury to persons.
- ! This appliance is not intended for use by persons (including children) with reduced physical, sensory or mental capabilities, or lack of experience and knowledge, unless they have been given supervision or instruction concerning use of the appliance by a person responsible for their safety. Children should be supervised to ensure that they do not play with the appliance.
- ! Never add cold water to food on a hot universal tray or baking tray or directly onto food in a hot oven. The steam created could cause serious burns or scalding and the sudden change in temperature can damage the enamel.
- ! Do not lift the oven by the handle .

SAFETY INSTRUCTIONS

This appliance can be used by children aged from 8 years and above if they have been given supervision or instruction concerning use of the appliance in a safe way and if they understand the hazards involved. Cleaning and user maintenance shall not be made by children unless they are aged from 8 years and above and supervised. Keep the appliance and its cord out of reach of children aged less than 8 years.

Appliances can be used by persons with reduced physical, sensory or mental capabilities or lack of experience and knowledge if they have been given supervision or instruction concerning use of the appliance in a safe way and if they understand the hazards involved.

Children shall not play with the appliance.

If the supply cord is damaged, it must be replaced by the manufacturer, its service agent or similarly qualified persons in order to avoid a hazard

WARNING: The appliance and its accessible parts become hot during use. Care should be taken to avoid touching heating elements.

Children less than 8 years of age shall be kept away unless continuously supervised

This appliance can be used by children aged from 8 years and above and persons with reduced physical, sensory or mental capabilities or lack of experience and knowledge if they have been given supervision or instruction concerning use of the appliance in a safe way and understand the hazards involved. Children shall not play with the appliance. Cleaning and user maintenance shall not be made by children without supervision.

During use the appliance becomes hot. Care should be taken to avoid touching heating elements inside the oven.

WARNING: Accessible parts may become hot during use.

Young children should be kept away.

Do not use harsh abrasive cleaners or sharp metal scrapers to clean the oven door glass since they can scratch the surface, which may result in shattering of the glass.

WARNING: Ensure that the appliance is switched off before replacing the lamp, to avoid the possibility of electric shock.

This appliance is not intended for use by persons (including children) with reduced physical, sensory or mental capabilities, or lack of experience and knowledge, unless they have been given supervision or instruction concerning use of the appliance by a person responsible for their safety.

Children should be supervised to ensure that they do not play with the appliance.

If the supply cord is damaged, it must be replaced by the manufacturer, its service agent or similarly qualified persons in order to avoid a hazard

HOW TO SAVE ENERGY



Using energy in a responsible way not only saves money but also helps the environment. So let's save energy! And this is how you can do it:

! Do not uncover the pan too often
(a watched pot never boils!)

Do not open the oven door unnecessarily often.

! Switch off the oven in good time and make use of residual heat.

For long cooking times, switch off heating zones 5 to 10 minutes before finishing cooking. This saves up to 20% on energy. Only use the oven when cooking larger dishes.

Meat of up to 1 kg can be prepared more economically in a pan on the cooker hob.

! Make use of residual heat from the oven.

If the cooking time is greater than 40 minutes switch off the oven 10 minutes before the end time.

Important! When using the timer, set appropriately shorter cooking times according to the dish being prepared.

! Make sure the oven door is properly closed.

Heat can leak through spillages on the door seals. Clean up any spillages immediately.

! Do not install the cooker in the direct vicinity of refrigerators /freezers.

Otherwise energy consumption increases unnecessarily.

UNPACKING

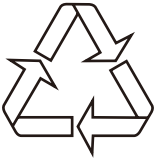

During transportation, protective packaging was used to protect the appliance against any damage. After unpacking, please dispose of all elements of packaging in a way that will not cause damage to the environment.

All materials used for packaging the appliance are environmentally friendly; they are 100% recyclable and are marked with the appropriate symbol.

Caution! During unpacking, the packaging materials (polythene bags, polystyrene pieces, etc.) should be kept out of reach of children.

DISPOSAL OF THE APPLIANCE



After the implementation of the European Directive 2002/96/EU in the national legal system, the following applies:

Electrical and electronic devices may not be disposed of with domestic waste. Consumers are obliged by law to return electrical and electronic devices at the end of their service lives to the public collecting points set up for this purpose or point of sale. Details to this are defined by the national law of the respective country. This symbol on the product, the instruction manual or the package indicates that a product is subject to these regulations. By recycling, reusing the materials or other forms of utilizing old devices, you are making an important contribution to protecting our environment.

DESCRIPTION OF THE APPLIANCE

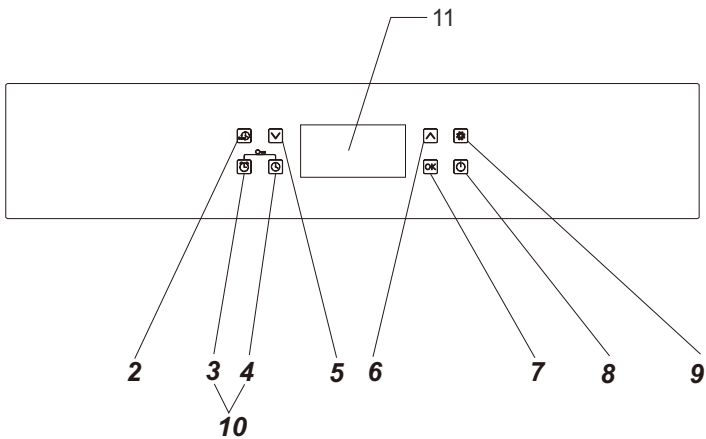
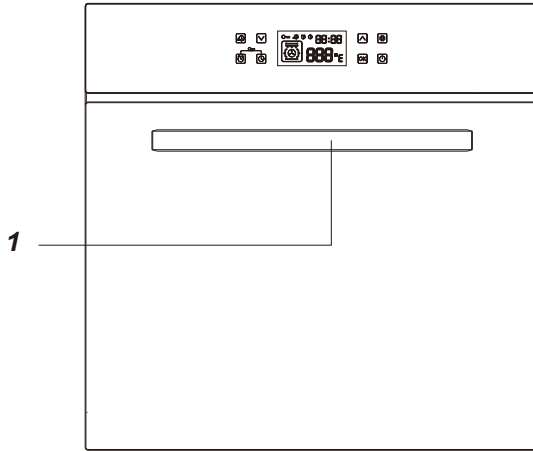

- 1 Oven door handle
- 2 Reservation function key
- 3 Timer
- 4 Clock
- 5 Descending key
- 6 Increasing key

- 7 Confirm key
- 8 Power key
- 9 Selection Key
- 10 Child lock key
- 11 Display

SPECIFICATIONS OF THE APPLIANCE

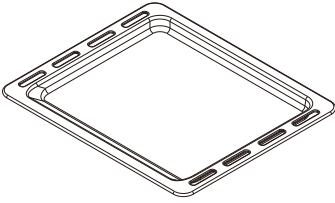

Baking tray

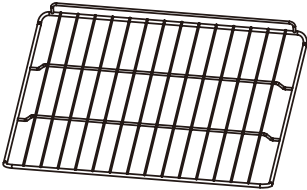

*Grill grate
(drying rack)*

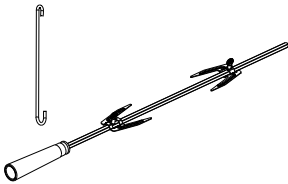

Rotisserie

INSTALLATION

!The kitchen area should be dry and aired and equipped with efficient ventilation. When installing the oven, easy access to all control elements should be ensured.

!This is a built-in oven, and its back wall and one side wall can be placed next to a high piece of furniture or a wall. Coating or veneer used on fitted furniture must be applied with a heat-resistant adhesive (100°C). This prevents surface deformation or detachment of the coating.

! Make an opening with the dimensions given in the diagram for the oven to be fitted.

!Make sure the mains plug is disconnected and then connect the oven to the mains supply.

!Insert the oven completely into the opening without allowing the four screws in the places shown in the diagram to fall out.

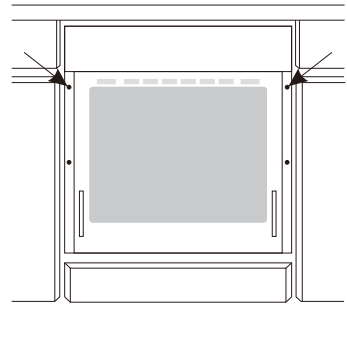
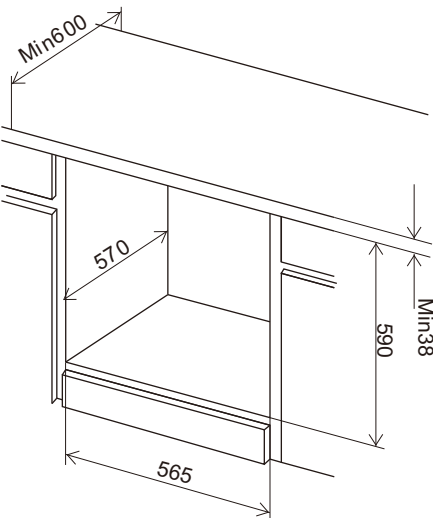
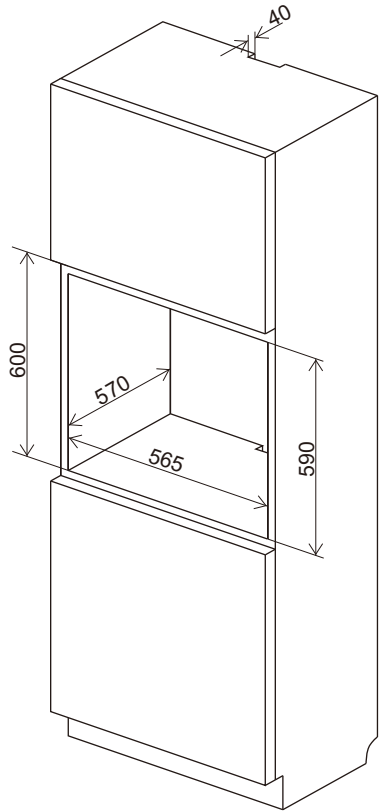

INSTALLATION

Electrical connection

Warning!

All electrical work should be carried out by a suitably qualified and authorised electrician. No alterations or wilful changes in the electricity supply should be carried out.

Fitting guidelines

The oven is manufactured to work with three-phase alternating current (220V–240V/50Hz). The connection diagram is also found on the cover of the connection holder. Remember that the connection wire should match the connection type and the power rating of the oven.

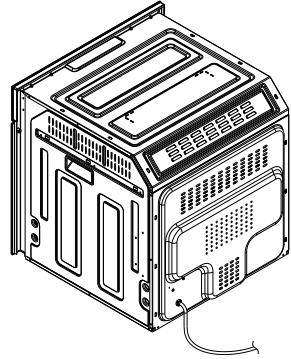

The connection cable must be secured in a strain-relief clamp.

Warning!

Remember to connect the safety circuit to the connection holder terminal marked with \oplus . The electricity supply for the oven must have a safety switch which enables the power to be cut off in case of emergency. The distance between the working contacts of the safety switch must be at least 3 mm.

Before connecting the oven to the power supply it is important to read the information on the data plate and the connection diagram.

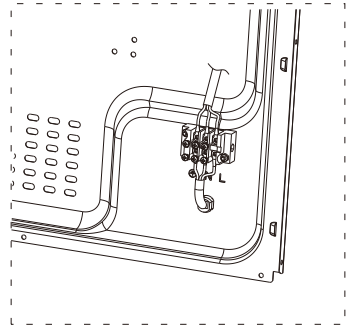

CONNECTION DIAGRAM

Caution! Voltage of heating elements 220V~240V

Caution! In the event of any connection the safety wire must be connected to the \oplus terminal

For 220V~240V, connection ways as below:

Yellow and Green Wire connects to \oplus

Blue Wire connects to N (neutral)

Brown Wire connects to L (live)

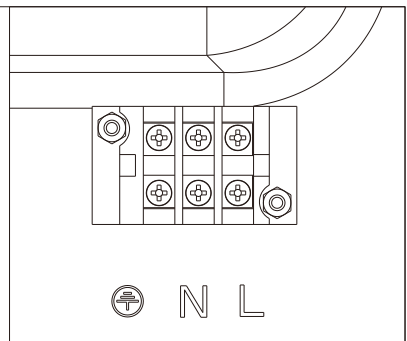

OPERATION

Before first use

!Remove packaging, clean the interior of the oven and the hob.

!Take out and wash the oven fittings with warm water and a little washing-up liquid.

Switch on the ventilation in the room or open a window.

!Heat the oven (to a temperature of 250°C, for approx. 30 min.), remove any stains and wash carefully; the heating zones of the hob should be heated for around 4 min. without a pan.

Important!

The inside of the oven should only be washed with warm water and a small amount of washing-up liquid.

OPERATION

LED display



1. Turn On and off

Turn on: when the product is off, touch , it is in standby status.

Turn off: In working status, touch , it is off .

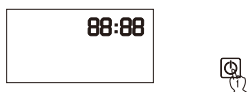

The LED displays below when in standby:



Note: when it is set up electricity, if the clock is not set up, it will not show time and only shows (0:00)

2. Set up clock (24 hours):

(1) In standby condition, touch  once, hour flicker, reminding to set up.

(2) Touch  or  keys, set up hours (0-23), defaulted "00".



(3) Touch  once again, finish hour set up, the minute flicker, reminding to set up.

(4) Touch  or  keys, set up minutes (0-59). Defaulted "00".



OPERATION

- (5) Touch  key once, clock setup finish, start to work. The “:” flicker once each second. (Example: 12:30)

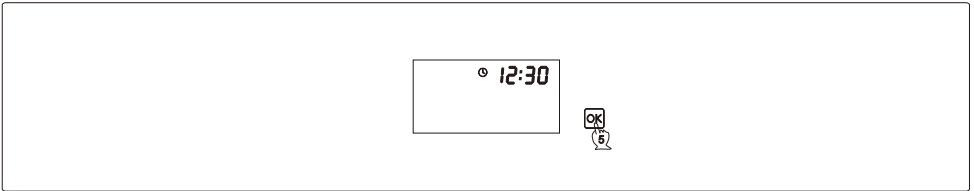



3. Function selection:  as example (other functions are same way to set)

- (1) In standby condition, touch  continuously, display shows as below diagram ("XX" means flicker, others are bright).





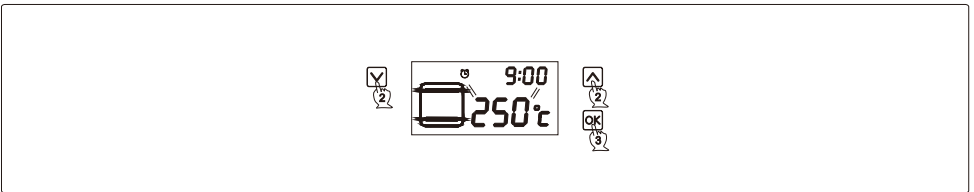

Note: All above are default under its function condition.

- (2) After function selection, can set up temperature and working time as below:

- a. Touch  or , touch one, the temperature can increase (or decrease) 5°C, temperature can be set between 40°C and 250°C.



- b. Touch  once, the hour flicker, touch  or  keys, can set time between 0 and 9 hours.

- c. Touch  once again (or touch twice continuously), minute flicker and touch  or  key, it can set up minutes between 0 and 59 minutes, touch  key, it will start to work, other icon will not show.

For example: Working time set as 3:30 hours, temperate set as 230 ° C..

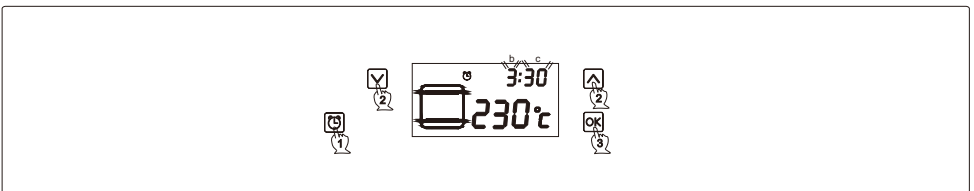

OPERATION















- d. Under condition of item 3-(1) or item 3-(2) , touch  key, it will work as system defaulted or current condition.





Table 1

| Icon |  |  |  |  |  |  |  |  |  |  |
|------------------------|---|---|---|---|---|---|---|---|---|---|
| Working mode | Upper heat+ lower heat + light + air exhaust fan | Rear heat+ convection + light+ air exhaust fan | Rear heat+ convection + lower heat+ light+ air exhaust fan | Grill+ convection + light+ air exhaust fan | Grill + light+ air exhaust fan | Upper heat + lower heat+ convection+ light+ air exhaust fan | Grill +rear heat + convection +lower heat +light +air exhaust fan | Lower heat+ light+ air exhaust fan | Grill+ rotisserie+ convection+ light+ air exhaust fan | Convection +light |
| Default temperature | 210 | 210 | 220 | 210 | 210 | 210 | 230 | 60 | 210 | — |
| Temperature can be set | 40-250 | 40-250 | 40-250 | 40-250 | 40-250 | 40-250 | 40-250 | 40-180 | 40-250 | — |
| Time can be set | 0:01-9:00 | | | | | | | | | |



4. Checking function

- (1) In working condition, touch  key, can check current time, flicker 5 times it will turn to original working condition automatically.
- (2) In working condition, touch  key, can check the time set up, flicker 5 times it will turn to original working condition automatically.
- (3) In working condition, touch  key continuously, can check the temperature set up, flicker 5 times it will turn to original working condition automatically.

5. Set up child lock

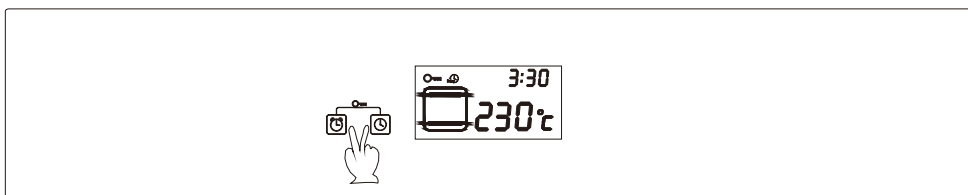
- (1) Lock: Touch  and  keys at the same time, keep touching more than 3 seconds until “” icon shows in LED, it is locked, besides “” key, there is no function to touch any other keys. Example:



- (2) Unlock: Touch  and  keys at same time, keep touching more than 3 seconds till “” icon doesn't show, then it is unlocked.

CLEANING AND MAINTENANCE

By ensuring proper cleaning and maintenance of your cooker you can have a significant influence on the continuing fault-free operation of your appliance.

Before you start cleaning, the cooker must be switched off and you should ensure that all knobs are set to the "OFF" position. Do not start cleaning until the cooker has completely cooled.

Caution! The sharp blade should always be protected by adjusting the cover (just push it with your thumb). Injuries are possible so be careful when using this instrument-keep out of reach of children

! Appropriate light cleaning or washing products are recommended, such as e.g. any kind of liquids or emulsions for fat removal. In particular, special cleaning products such as COLLO Luneta, Sidol Stahlglanz, Stahl-Fix for washing and cleaning and Cera Fix for maintenance are recommended. If the recommended products are not available, it is advisable to use a solution of warm water with a little washing-up liquid or cleaning products for stainless steel sinks.

CLEANING AND MAINTENANCE

Oven

!The oven should be cleaned after every use. When cleaning the oven the lighting should be switched on to enable you to see the surfaces better.

!The oven chamber should only be washed With warm water and small amount of washing-up liquid.

!After cleaning the oven chamber wipe it dry.

Caution!

Do not use cleaning products containing abrasive materials for the cleaning and maintenance of the glass front panel.

!steam cleaning

-pour 250ml of water(1 glass)into a bowl placed in the oven on the first level from the bottom,

-close the oven door,

-set the temperature knob to 50°C ,and the function knob to the bottom heater position,

-heat the oven chamber for approximately 30 minutes,

-open the oven door, wipe the chamber inside with a cloth or sponge and wash using warm water with washing-up liquid.

Caution! Possible moisture or water residues under the cooker can result from steam cleaning.

!After cleaning the oven chamber wipe it dry.

Replacement of the oven light bulb

In order to avoid the possibility of an electric shock ensure that the appliance is switched off before replacing the bulb.

!Set all control knobs to the position "OFF"/ "STOP" and disconnect the mains plug,

!unscrew and wash the lamp cover and then wipe it dry.

!unscrew the light bulb from the socket, replace the bulb with a new one-a high temperature bulb (300°C)with the following parameters:

-voltage 220~240 V

-power 15 W

-thread E14.

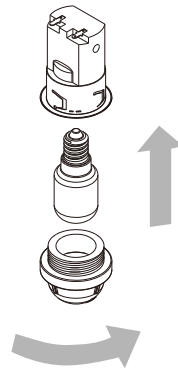

Oven light bulb

!Screw the bulb in , making sure it is properly inserted into the ceramic socket.

!Screw in the lamp cover.

CLEANING AND MAINTENANCE

Door removal

In order to obtain easier access to the oven chamber for cleaning, it is possible to remove the door. To do this, tilt the safety catch part of the hinge upwards. Close the door lightly, lift and pull it out towards you. In order to fit the door back on to the cooker, do the inverse. When fitting, ensure that the notch of the hinge is correctly placed on the protrusion of the hinge holder. After the door is fitted to the oven, the safety catch should be carefully lowered down again. If the safety catch is not set it may cause damage to the hinge when closing the door.

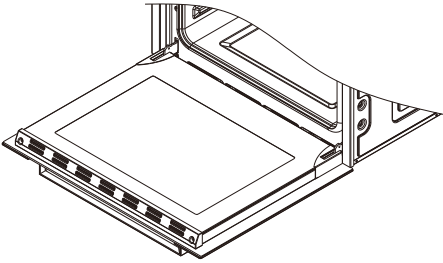

Door removal

Removal of the internal glass panel

Unscrew and unfasten the plastic latch that is in the corner at the top of the door. Next take out the glass from the second blocking mechanism and remove. After cleaning, insert and block the glass panel, and screw in the blocking mechanism.

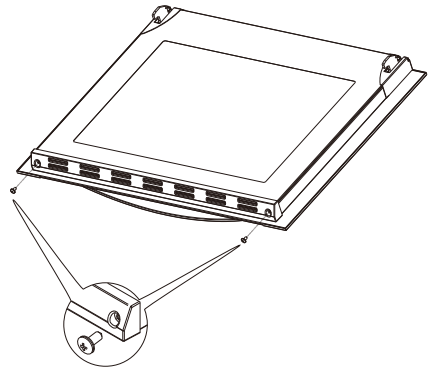

Removal of the internal glass panel

OPERATION IN CASE OF EMERGENCY

In the event of an emergency, you should:

!switch off all working units of the cooker

!disconnect the mains plug

!call the service centre

!Some minor faults can be fixed by referring to the instructions given in the table below. Before calling the customer support centre or the service centre check the following points that are presented in the table.

| PROBLEM | REASON | ACTION |
|---------------------------------|------------------------------|--|
| The appliance does not work. | break in power supply | check the household fuse box, if there is a blown fuse replace it with a new one |
| The oven lighting does not work | the bulb is loose or damaged | tighten up or replace the blown bulb (see chapter Cleaning and Maintenance) |

TECHINCAL DATA

| | |
|------------------------------|----------------|
| Voltage rating | 220V-240V 50Hz |
| Power rating | max. 3.2kw |
| Cooker dimensions H/W/D (cm) | 59.5/59.5/57.5 |
| Usable capacity of the oven | 65 litres |
| Net weight | Approx. 32kg |