

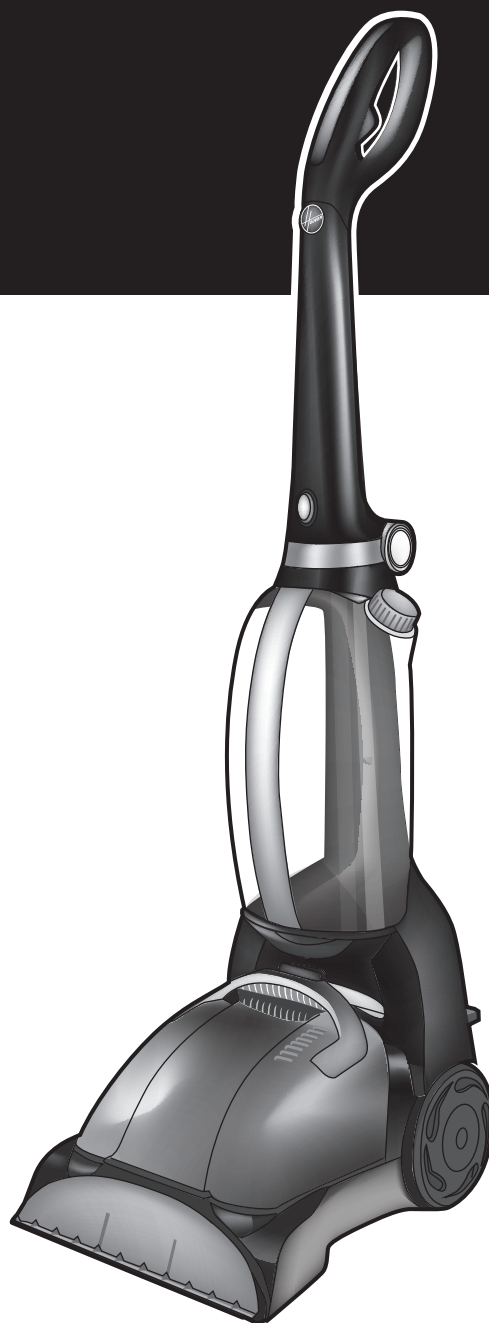

GENERATION FUTURE

HOOVER



USER MANUAL

IMPORTANT SAFETY REMINDERS

This cleaner should only be used for domestic cleaning, as described in this user guide. Please ensure that this guide is fully understood before operating the appliance.

Only use attachments recommended or supplied by Hoover.

WARNING: Electricity can be extremely dangerous. This appliance must be earthed. This plug is fitted with a 13 amp fuse (UK only).

IMPORTANT: The wires in the mains power lead are coloured in accordance with the following code: **Blue – Neutral** **Brown – Live**

STATIC ELECTRICITY. Some carpets can cause a small build up of static electricity. Any static discharge is not hazardous to health.

AFTER USE. Switch the cleaner off and remove the plug from the electricity supply. Always switch off and remove the plug before cleaning the appliance or attempting any maintenance task.

HOOVER SERVICE. To ensure the continued safe and efficient operation of this appliance we recommend that any servicing or repairs are only carried out by an authorised Hoover service engineer.

This appliance can be used by children aged from 8 years and above and persons with reduced physical, sensory or mental capabilities or lack of experience and knowledge if they have been given supervision or instruction concerning use of the appliance in a safe way and understand the hazards involved. Children shall not play with the appliance. Cleaning and user maintenance shall not be made by children without supervision.

IT IS IMPORTANT THAT YOU:

- Use indoors only.
- Use only on surfaces moistened by the cleaning process or small spills. Do not immerse product.
- Close supervision is necessary when any appliance is used by or near children. Do not allow cleaner to be used as a toy or to run unattended at any time.
- Keep hair, loose clothing, fingers, feet and all parts of body away from openings and moving parts.
- Do not pick up anything that is burning or smoking, such as cigarettes, matches, or hot ashes.
- DO NOT use aerosol sprays near cleaner. Aerosol sprays may be flammable.
- Do not pick up or use flammable or combustible materials such as gasoline or fine wood sandings or use in areas where they may be present.
- Avoid picking up hard, sharp objects with the cleaner. They may damage the machine.

IT IS IMPORTANT THAT YOU:

- Do not put any object into openings. Do not use with any opening blocked; keep free of dust, lint, hair, and anything that may reduce flow.
- Do not pull or carry by the cord, use the cord as a handle, close door on the cord or pull the cord around sharp edges or corners. Do not run appliance over the cord. Keep the cord away from heated surfaces.
- Always disconnect the cord from electrical outlet before servicing the cleaner.
- Unplug the cleaner when not in use. Turn off all controls before unplugging.
- Do not unplug by pulling on the cord. To unplug, grasp the plug, not the cord.
- Never handle the plug or appliance with wet hands.
- Do not clean over floor electrical outlets.
- Do not use without the tanks in place.
- Keep detergents and other cleaners out of children's reach.
- Do not pick up chlorine bleach, drain cleaner, gasoline or any other toxic

IT IS IMPORTANT THAT YOU:

- material with this appliance.
- When using recommended chemicals with this machine, be certain the area is well ventilated.
- Do not use a flammable or combustible liquid to clean a floor.
- Follow manufacturer's instructions for all chemicals used with this machine. Do not exceed recommended mixing ratios.
- Store in a dry place. Do not expose the cleaner to freezing temperatures.
- Do not continue to use your cleaner if it appears to be faulty. If the power cord is damaged stop using the cleaner IMMEDIATELY. To avoid a safety hazard, an authorised Hoover service engineer must replace the power cord.
- Use the cleaner only for its intended use as described in the instructions.

GETTING TO KNOW YOUR CLEANER

Congratulations on the purchase of your new Hoover.

Please take the time to read this manual carefully.

You'll then be ready to make the most of the special features only the new Hoover can offer!

When first unpacking your cleaner please check all items are included:

Cleaner body
Cloth adapter plate*
Cloth*

In the unlikely event that any item is missing or you experience any problems with the product

DO NOT TAKE IT BACK TO THE SHOP

Please contact the Hoover customer helpline:
Tel: 08444 995 599
Email: customer.services@hoovercandy.com

Should any faults occur with your cleaner during the first 12 months, contact the Hoover Customer Helpline on the number above.

If you are having difficulty in obtaining filters or any other accessories for your cleaner, contact the Hoover Customer helpline or order online at www.hooverspars.com

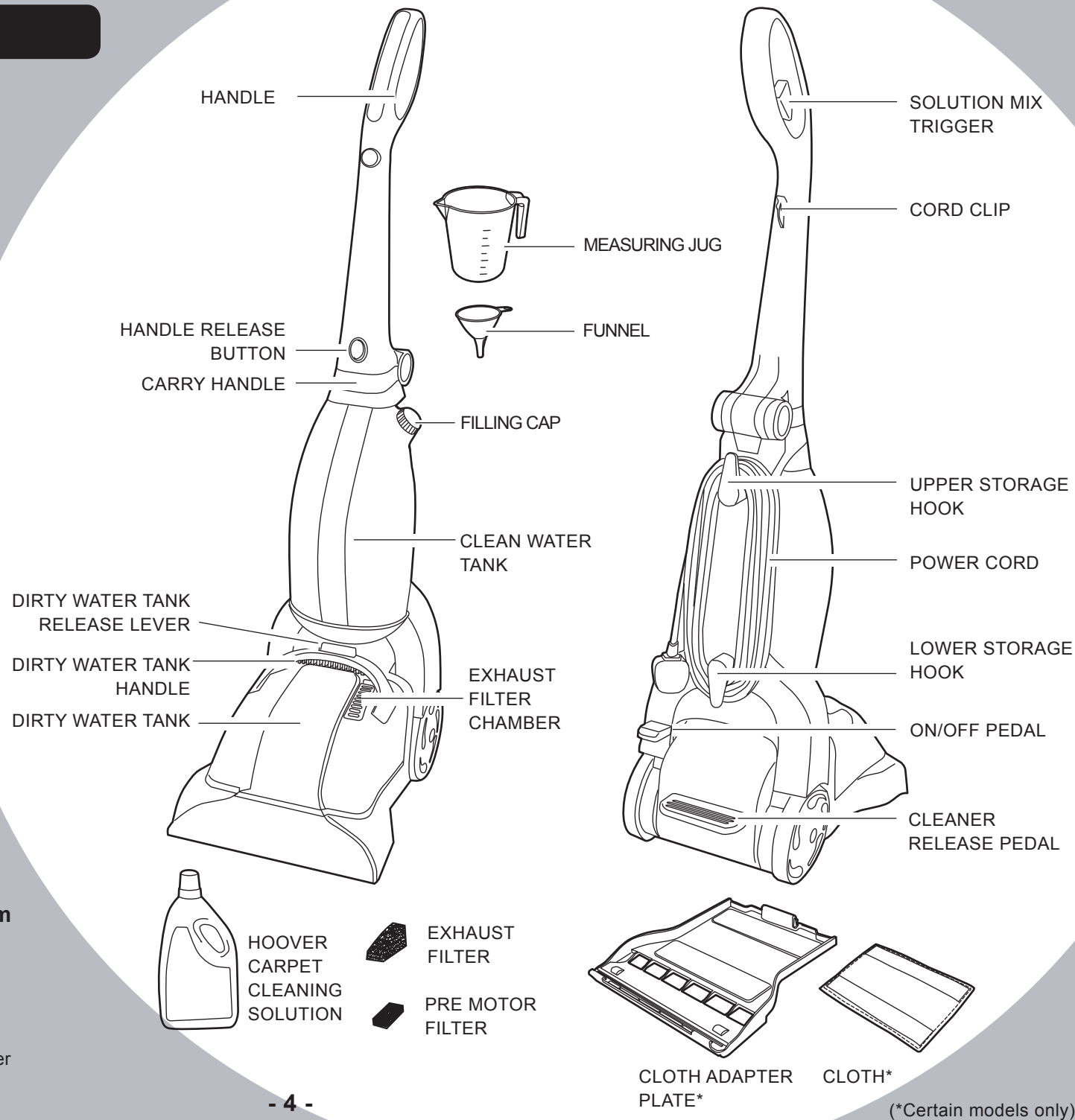

PREPARING YOUR CLEANER

- 1 Remove the accessories from the main packaging. You should find the following:

Cleaner body
Cloth adapter plate*
Cloth*

- 3 To fold the handle press the handle release button and fold to the storage position.

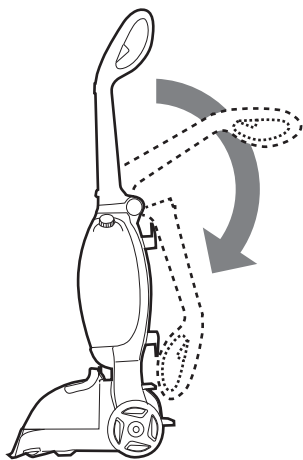

- 2 Raise the handle to the upright position until it locks in place.

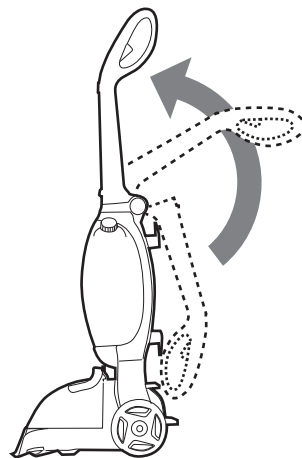

- 4 Once the handle has been lowered lift the carry handle to allow the cleaner to be carried from room to room.

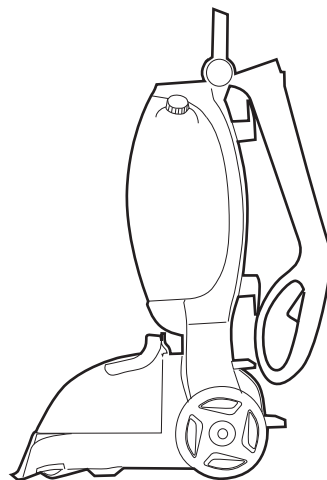

BEFORE CLEANING A CARPET

- Vacuum thoroughly.
- Test for colourfastness
- Move the furniture

Test for colourfastness - Wet a white absorbent cloth with the solution. In a small, hidden area of your carpet, gently rub the surface with the dampened cloth.

Wait ten minutes and check for colour removal or bleed with a white paper towel.

If your carpet has more than one colour, check all colours.

When cleaning an entire room, move furniture out of the area to be cleaned. If the furniture is too heavy to move, place aluminium foil or wax paper under legs. This will prevent wood finishes from staining your carpet. Pin up furniture skirts and curtains.

NOTE: Do not over saturate your carpet.



IMPORTANT: This cleaner should not be used to dry vacuum the carpet.

(*Certain models only)

FILLING THE CLEAN WATER TANK

The clean water tank holds the water and cleaning solution.

IMPORTANT: Always turn the cleaner off and disconnect from the electrical outlet before filling the clean water tank.



IMPORTANT: When filling the clean water tank, do not exceed the max fill line.

- 1 Add the required amount of cleaning fluid to a measuring jug. (approx. 40ml per 1L of water)



- 2 Mix the solution with warm water. (Max. temperature - 40°C)

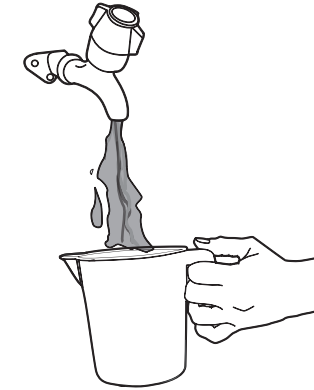

- 3 Open the filling cap on the water tank.

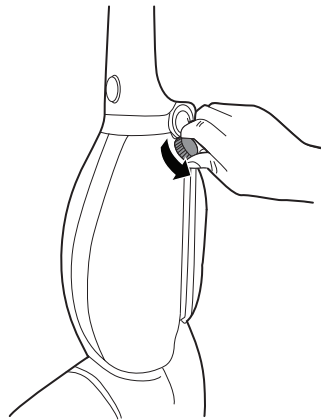

- 4 Pour the solution into the clean water tank. Do not exceed the max fill line.

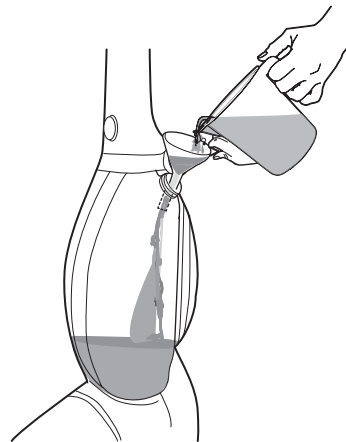

- 5 Close the filling cap on the water tank.

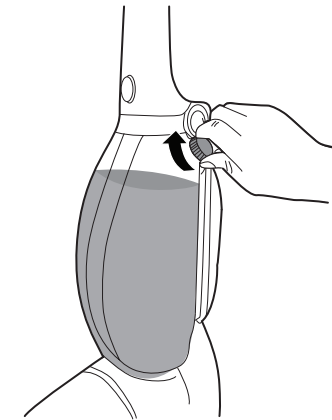

WARNING: Use only Hoover carpet cleaning solution. Using other solution brands may cause excess foaming and will prevent the cleaner from working effectively. Using other solutions may affect your warranty.

CLEANING CARPETS

Dry vacuum the carpet thoroughly before cleaning your carpet.

Ensure the carpet has been checked for colour fastness.



IMPORTANT: This cleaner should not be used to dry vacuum the carpet.

- 3 Press the cleaner release pedal and recline the cleaner.

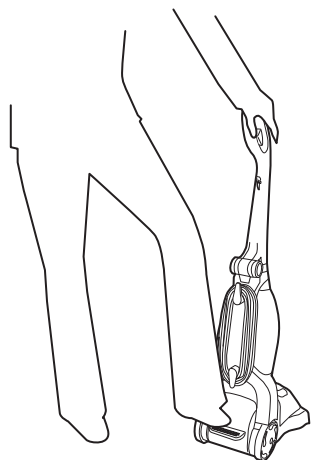

- 1 Unwrap the power cord and plug the cleaner into the power supply.

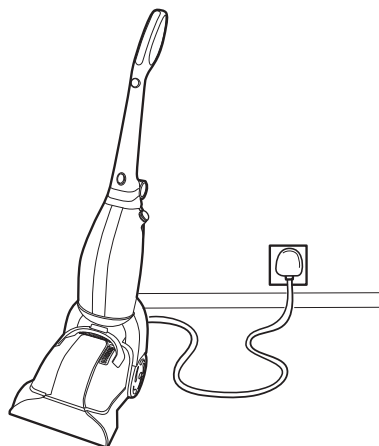

- 4 Press the solution mix trigger to release the solution.

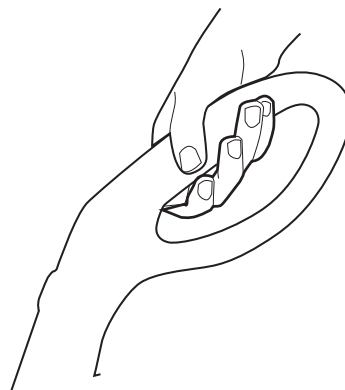

- 2 Press the ON/OFF pedal.

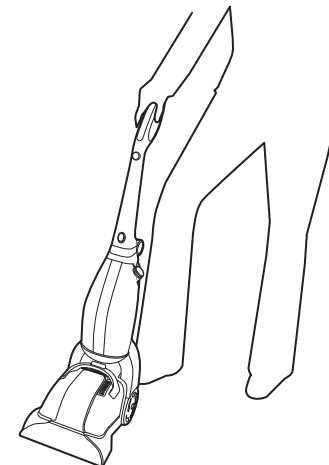

- 5 For best results apply the solution on the forward stroke (press trigger) and recover the solution on the backward stroke (release trigger).

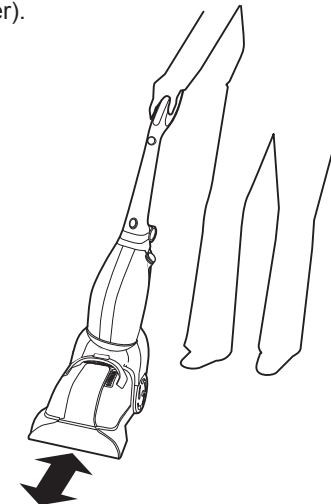

WARNING: Use only Hoover carpet cleaning solution. Using other solution brands may cause excess foaming and will prevent the cleaner from working effectively. Using other solutions may affect your warranty.

CLEANING HARD FLOORS*

- 1 Attach the Velcro side of the cloth to the underside of the cloth adaptor plate.

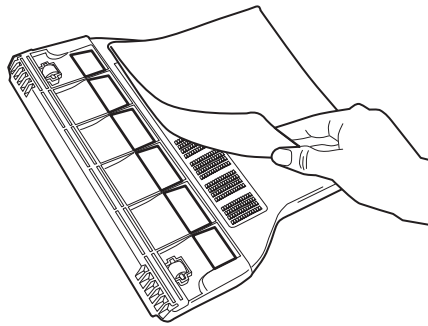

Attached the cloth adapter plate to the foot of the cleaner.

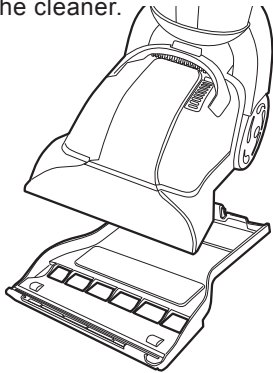

- 2 Use the cleaner as described in 'Cleaning Carpets'.
- 3 After use remove the cloth from the adapter plate and wash the cloth pad in a washing machine with a mild detergent at maximum temperature 30°C. Do not use a fabric softener.

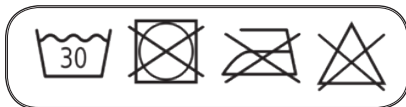

! **WARNING: Use only Hoover carpet cleaning solution. Using other solutions may affect your warranty.**

* Certain models only

STORAGE

Before storing the cleaner:

Turn the cleaner off and disconnect from the electrical socket.

Empty and rinse the dirty water tank. Allow to air dry.

Press the handle release button and lower the handle for storage.

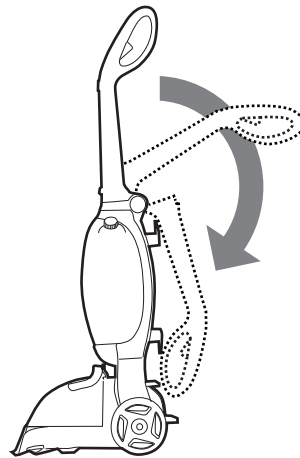

Do not store the cleaner on a wood surface unless the cleaner is completely dry.

CORD STORAGE

Turn the cleaner off and remove the plug from the electrical socket. Wind the power cord around the cord storage hooks.

Rotate the storage hooks to quickly release the full length of the power cord.

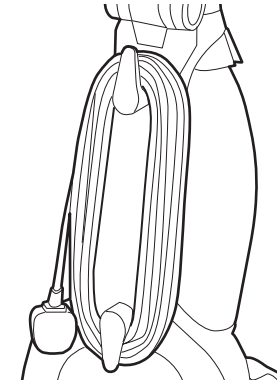

CORD CLIP

Do not run over the power cord.

Clip the power cord in the cord clip at the back of the handle to avoid accidentally running the cleaner over the cord and causing any damage



EMPTYING THE DIRTY WATER TANK

! **WARNING: DO NOT** exceed the max fill line on the dirty water tank.

- 1** Press the dirty water tank release lever.

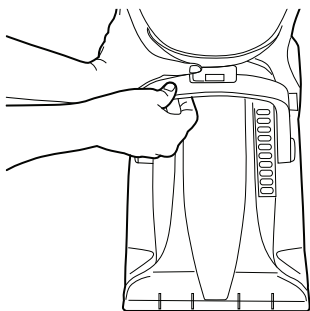

- 2** Remove the dirty water tank from the cleaner,

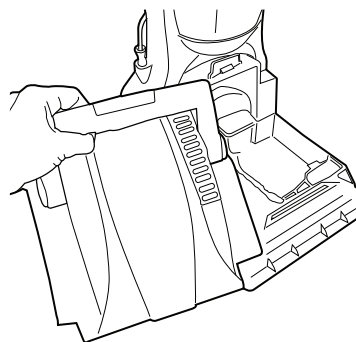

- 3** Turn the tank cap anti-clockwise to open.

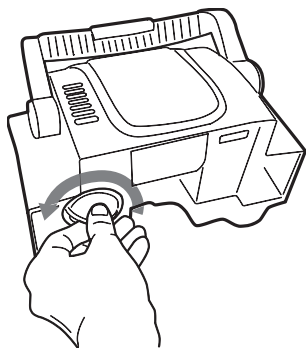

- 4** Empty the tank. Rinse the tank with clean water and allow to dry before storing the cleaner.

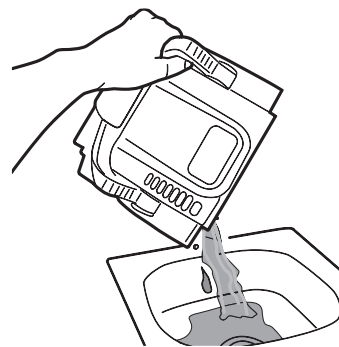

! **WARNING: Always** switch the cleaner off and unplug it from the electrical socket before emptying the dirty water tank.

CLEANING THE EXHAUST FILTER

Press the exhaust filter release latch.

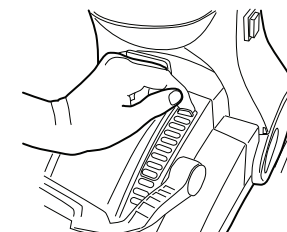

Remove the exhaust filter chamber.

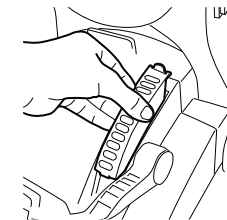

Remove the filter from the chamber. Rinse under hand warm water to remove any debris. Allow to completely dry before returning to the cleaner

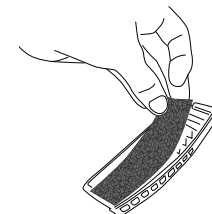

CLEANING THE PRE MOTOR FILTER

The pre motor filter is located under the dirty water tank.

Rinse under hand warm water to remove any debris. Allow to completely dry before returning to the cleaner.

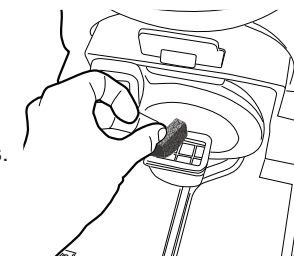

! **IMPORTANT: Clean** the filters after each use.

! **WARNING: Ensure** both filter are fitted to the cleaner before use.

CLEANING THE BRUSHBAR*

Turn the cleaner upside down. Remove any threads or debris from the brush bar.

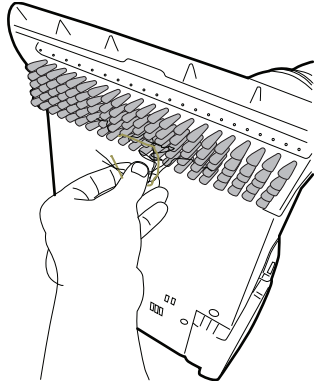

CLEANING THE AGITATOR*

Remove any threads or debris ensuring the agitator can rotate freely.

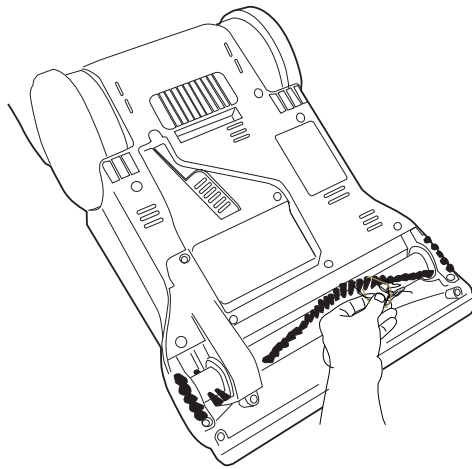

! THIS FEATURE VARIES ACCORDING TO MODEL

Please check the underside of your cleaner and follow the appropriate instructions.

CHANGING THE BRUSHBAR*

- 1 Press the dirty water tank release lever and remove the dirty water tank. Unscrew 4 retaining screws on the top surface.

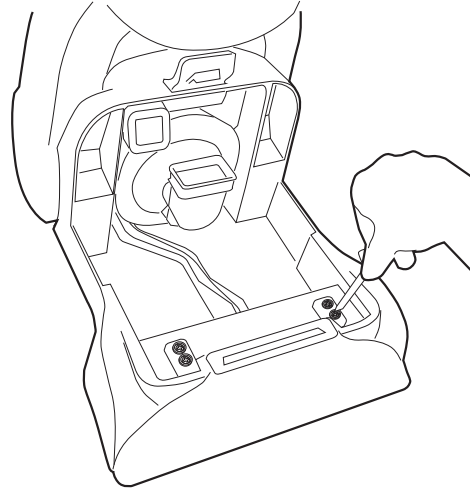

- 3 Unscrew 2 retaining screws located on the underside of the detergent nozzle. Remove the brushbar from the nozzle.

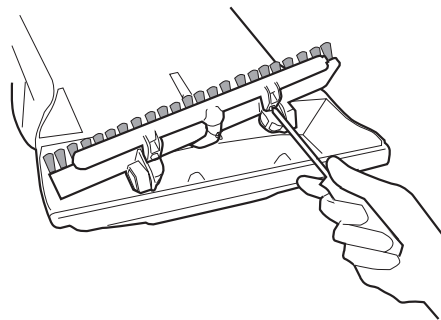

! THIS FEATURE VARIES ACCORDING TO MODEL
Please check the underside of your cleaner and follow the appropriate instructions.

! **IMPORTANT:** Switch the cleaner off and remove the plug from the electricity supply before dismantling cleaner

- 2 Turn the cleaner over. Remove the brushbar alignment brackets.

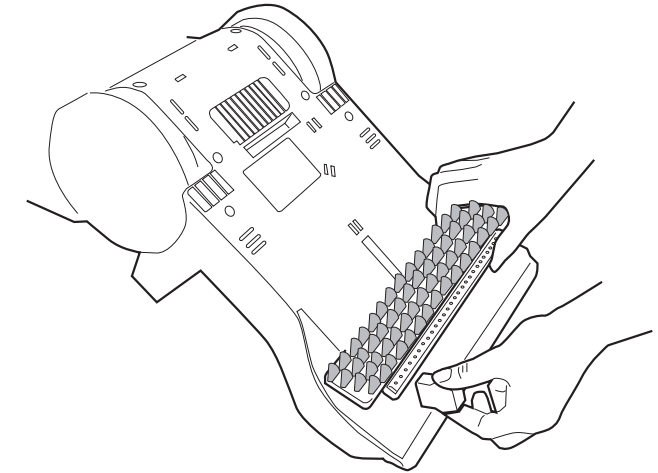

- 4 Replace the brush bar and attach to the nozzle. Attach the alignment brackets and assemble to the cleaner.

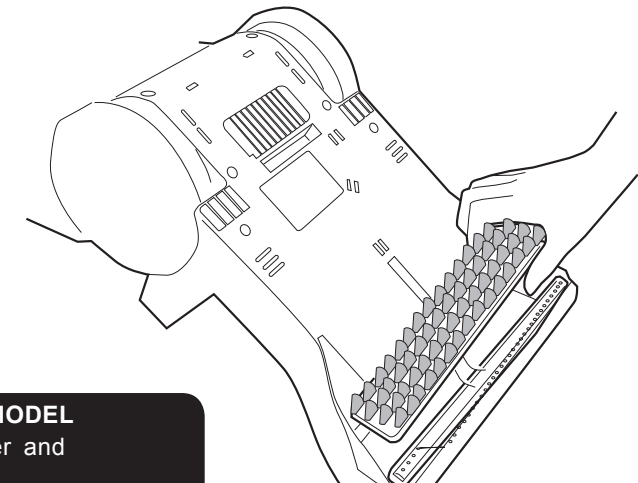

* Certain models only

CHANGING THE AGITATOR / BELT*

- 1 Turn cleaner over and remove 7 retaining screws.

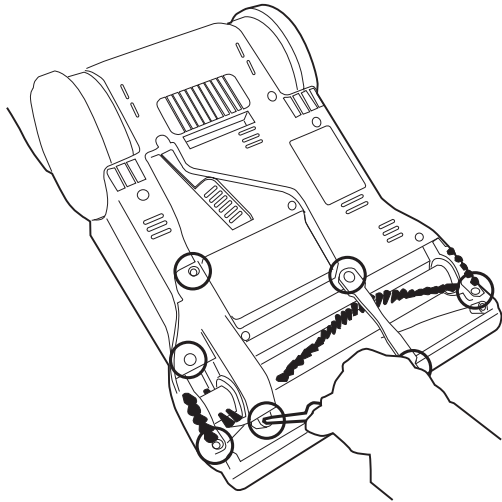

- 4 Remove the agitator brackets.

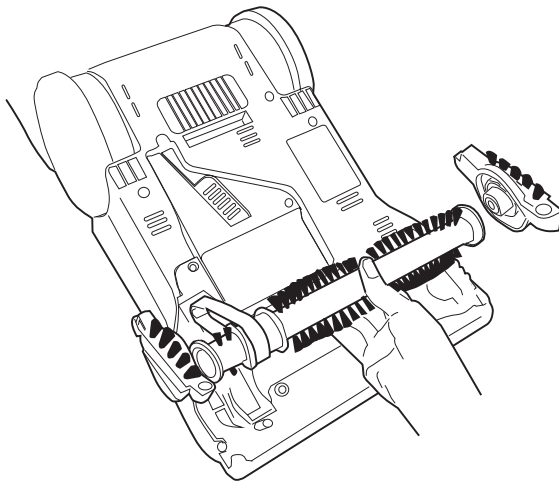

- 2 Remove the belt cover and safety bar.

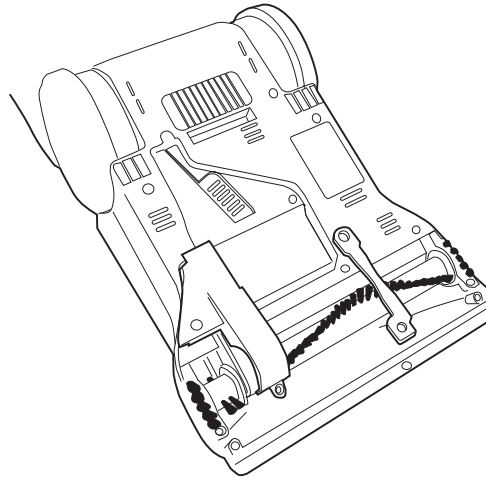

- 5 Replace the agitator by looping the belt round the agitator making sure it sits securely in the belt channel.

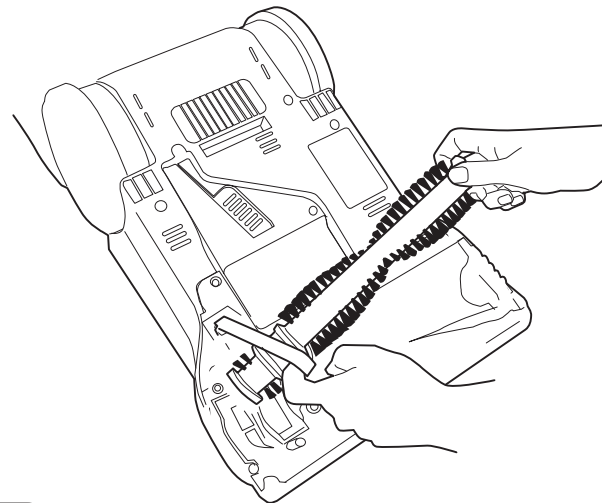

- 3 Slide the agitator assembly out of the cleaner and check the belt for wear.

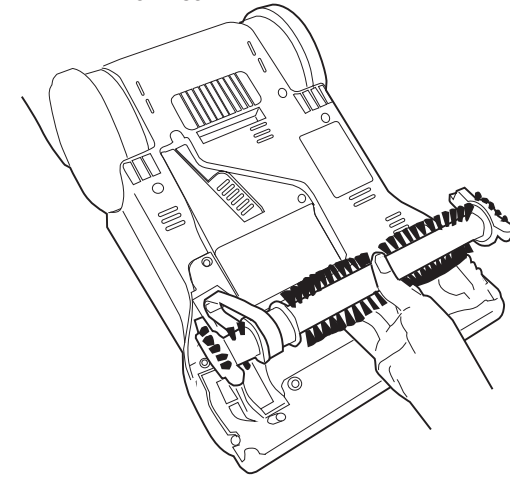

- 6 Reassemble the agitator assembly to the cleaner ensuring the agitator can rotate freely.

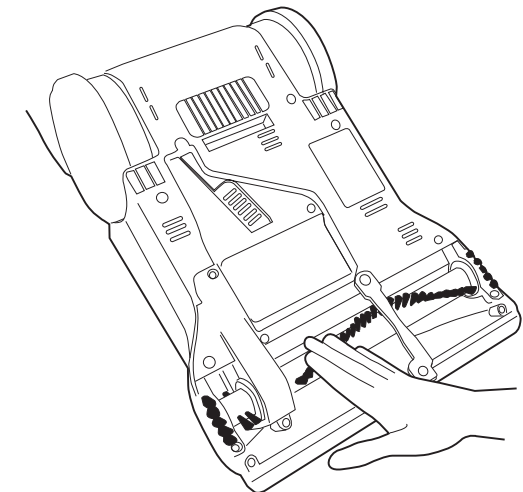

THIS FEATURE VARIES ACCORDING TO MODEL
Please check the underside of your cleaner and follow the appropriate instructions.

* Certain models only

Troubleshooting

If your cleaner is not working properly run through the following checklist.

WARNING: To reduce the risk of personal injury, unplug the carpet washer before performing maintenance/troubleshooting checks.

Why won't the carpet washer turn on?

- It may not be plugged into the electrical outlet correctly: ensure that the plug is pushed in securely and switched on.
- The power button on the unit hasn't been fully depressed.
- If unit cuts out during use, disconnect the unit from the wall socket, allow to cool for one hour, clean the filter and empty the dirty water tank and check hose, brushbar for blockages.

Why won't the cleaner pick up solution/spills?

- The dirty water tank may be full and the auto shut off engaged. Empty the dirty water tank.
- Ensure the dirty water tank is fitted correctly and the tank cap is securely fitted.
- Check the brushbar for blockages.

Why won't the solution/clean water dispense?

- The solution/clean water tank may be empty.
- Ensure dirty water tank is fitted securely.

If there is any doubt call the **Hoover Customer Helpline 08444 995 599** for advice. They may be able to assist you over the telephone.

Genuine HOOVER Spares

Tel. 08443 712 758
www.hooverspares.com

Always replace parts with genuine Hoover spares. When ordering parts, always quote your model number.

Hoover Customer Helpline

Should any faults occur with your cleaner during the first 12 months, contact the Hoover Customer Helpline on the number below.

Tel: 08444 995 599
Email: customer.services@hoovercandy.com

Hoover have a computerised nationwide service network of over 500 engineers who will quickly respond to your call and guarantee your repair for 12 months.

USE ONLY HOOVER SPARES

SPARE PARTS	CODE
AGITATOR	Y30 35601321
BELT	V35 35601322
CLOTH AND ADAPTOR	AC20 35601323
FIXED BRUSHBAR	F4PJET 35601324
CLEANJET SOLUTION	35601351
FILTER KIT	35601352

Quality

BSI ISO 9001

Hoover's factories have been independently assessed for quality. Our products are made using a quality system which meets the requirements of ISO 9001

Environment - WEEE Directive



This appliance is marked according to the European Directive 2011/65/EC on Waste Electrical and Electronic Equipment (WEEE).

By ensuring this product is disposed of correctly you will help prevent potential negative consequences for the environment and human health, which could otherwise be caused by inappropriate waste handling of this product.

The symbol on the product indicates that this product may not be treated as household waste. Instead it shall be handed over to the appliance collection point for recycling of electrical and electronic equipment.

Disposal must be carried out in accordance with the local environmental regulations for waste disposal.

For more detailed information about treatment, recovery and recycling of this product, please contact your local city office, your household waste disposal service or the shop where you purchased the product.

CE This product complies with the European Directives 2006/95/EC, 2004/108/EC and 2011/65/EC.

HOOVER Limited Pentrebach, Merthyr Tydfil, Mid Glamorgan CF48 4TU

GUARANTEE STATEMENT

The guarantee conditions for this appliance are as defined by our representative in the country in which it is sold. Details regarding these conditions can be obtained from the dealer from whom the appliance was purchased. The bill of sale or receipt must be produced when making any claim under the terms of this guarantee.

Subject to change without notice.



GENERATION FUTURE

Hoover Limited
Pentrebach
Merthyr Tydfil
Mid Glamorgan
CF48 4TU, UK

HOOVER CUSTOMER HELPLINE
08444 995 599

© 2013 48008882