

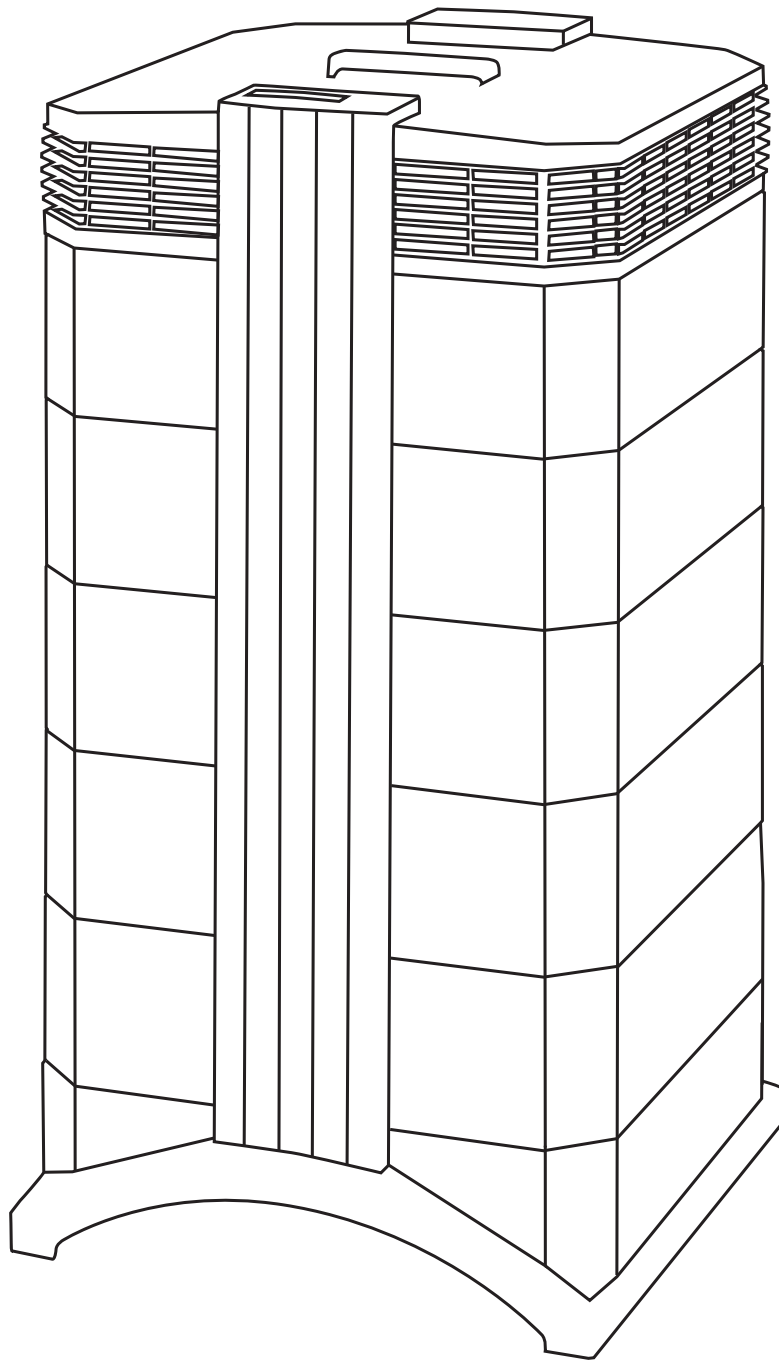

First in Air Quality

GC Series

User Manual



Important Safety Instructions

About This User Manual

Congratulations on your purchase of this IQAir high-performance air cleaning system. Please study this user manual carefully to familiarize yourself with the special features and functions of your IQAir system and keep it in a safe place for future reference.

Read these instructions before using the air cleaner:

- Do not use this air cleaner as sole protection against harmful pollutants.
- Do not immerse the air cleaner in water or other liquids.
- Always disconnect the power from this air cleaner by unplugging the power cord before adding or removing parts and before cleaning.
- Do not operate this air cleaner if it has a damaged cord or plug, if the motor fan fails to rotate, if it is not working properly, if it has been dropped or damaged, or dropped into water.
- If the power cord of this air cleaner should become damaged, it may be replaced with a similar two-pole cord, as is commonly used for computers and similar appliances. Replacement cords are available from IQAir.
- Only use this air cleaner for its intended purpose of air cleaning in non-industrial environments.
- Do not use this air cleaner in areas with very high concentrations of dust or powder to prevent the danger of dust explosions.
- Do not use this air cleaner in explosive areas.
- Do not use attachments or filters not recommended by IQAir.
- Do not use outdoors.
- Do not obstruct the air inlet and air outlet of the air cleaner.
- Do not place the air cleaner on a soft surface such as a bed or other soft furnishings.
- Only use this air cleaner in an upright position.
- Do not place next to a humidifier.
- Keep the power cord away from heated surfaces.
- Save these instructions for future reference.

The IQAir Group reserves the right to change specifications contained in this document at any time and without prior notice.

© 2002-2012 The IQAir Group. All rights reserved. IQAir is the registered trademark of The IQAir Group. EvenFlow is a trademark of The IQAir Group. IQAir systems and filters are protected under U.S. patents 6 001 145 and 6 159 260. Other U.S., European and Asian patents pending.

Table of Contents

	Page
Important Safety Instructions	2
Chapter 1 – Air Cleaning Systems and Indoor Air Quality	4
1.1 Improving Indoor Air Quality	4
Chapter 2 – Setting Up	5
2.1 Unpacking	5
2.2 Choosing a Suitable Location	6
2.3 Connecting to Power	6
2.4 Fitting and Removing Casters	7
Chapter 3 – The IQAir® System’s Components	9
3.1 Description of Housing Components	9
3.2 Description of Removable Components	10
3.3 How the IQAir System Works	10
Chapter 4 – Using the Control Panel	11
4.1 Description of Control Panel	11
4.1.1 Description of Control Panel Keys	11
4.2 Control Panel Locking Function	12
4.3 Fan Speed and Air Delivery	12
4.3.1 Regulating Fan Speed	12
4.3.2 Air Exchange Rates in Differently Sized Rooms	13
4.4 Using the Menu Functions	13
4.4.1 Menu Overview	13
4.4.2 Filter Life Monitor	14
4.4.3 Setting the Auto Timer	15
4.4.4 Day-of-the-Week Timer	16
4.4.5 Timer ON/OFF Fan Speed Selection Menu	16
4.4.6 Timer Information in the Control Panel	17
4.4.7 Time & Day Setting	18
4.4.8 Filter Life Reset (New Filter)	18
4.4.9 Changing the Airflow Units	19
4.4.10 Language Setting	19
Chapter 5 – Using the Remote Control	20
5.1 Remote Control Elements and Functions	20
5.2 Getting the Best Transmission Results	20
5.3 Replacing the Battery of the Remote Control	21
Chapter 6 – Replacing Filters	21
6.1 Location of the Filters	21
6.2 Ordering Replacement Filters	21
6.3 Opening and Closing the Housing	22
6.3.1 Troubleshooting When Closing the Housing	22
6.4 Replacing the Pre-Filter (F1)	22
6.5 Replacing the Gas Phase Filter Cartridges and Post-Filter Sleeves (F2)	23
6.6 Discarding Used Filters	24
Chapter 7 – Maintenance	24
7.1 Cleaning the Housing	24
7.2 Maintenance-Free Fan	24
7.3 Technical Support and Repairs	24
7.4 IQAir Warranty	24
Chapter 8 – IQAir® Optional Accessories	25
Technical Specifications	26

Chapter 1 – Air Cleaning Systems and Indoor Air Quality

State-of-the-art filtration technology

Your IQAir advanced air cleaning system has been developed especially for the control of specific gaseous components. Thanks to advanced gas cartridge (GC) filter technology, each model of the IQAir GC Series has been optimized for the control of specific gaseous pollutant groups. The following model configurations are available:

- **IQAir GC VOC** for the control of volatile organic compounds
- **IQAir GC MultiGas** for the control of volatile organic compounds and many inorganic compounds
- **IQAir GC Chemisorber** for the control of many inorganic compounds and some organic compounds
- **IQAir GC AM** for the control of ammonia and amines

1.1 Improving Indoor Air Quality

Air cleaning can play an important role when it comes to improving indoor air quality. However, it should be noted that air cleaning should be used in conjunction with pollution source control and ventilation, wherever possible.

Strategy to improve indoor air quality

To tackle any indoor air quality problem, keep the following three-step strategy in mind:

1. Eliminate or reduce the air pollution source as much as possible. Source control is by far the most effective way to improve indoor air quality, since it sets out to deal with air pollution at the point of origin.
2. Ensure that sufficient fresh air is entering the room from outside. Air cleaners are not a substitution for sufficient ventilation. They are not able to reverse the conversion of oxygen (O₂) into carbon dioxide (CO₂), caused by breathing and combustion processes.
3. Ensure the IQAir system can clean enough air to cope with your room size. The actual hourly air volume cleaned by the system should be at least double the air volume of your room. If the rate at which pollutants enter the room air is high or the indoor air quality requirements are stringent, the hourly air delivery of the system needs to exceed the room air volume several times. To achieve that level of air turnover, it may be necessary to employ more than one IQAir system, or consider the larger GCX model (refer to section 4.3.2).

Air Cleaning Results

Although air cleaners may be advertised and sold to be suitable for use in specific indoor environments and to deal with specific indoor air quality problems, the manufacturer and distributors make no claim as to the specific air cleaning results that are achieved under the user's individual operating conditions. The air quality improvements that can be realized with the IQAir system (as with any air cleaner) in indoor environments depends to a significant degree on circumstantial factors, which are out of the control of the manufacturer or distributors. Important factors which will influence the air quality improvements that can be achieved in an indoor environment with an air cleaner include:

- Type of air pollutants present and their filtration efficiency
- Intensity of the pollutant source(s)
- Pollutant concentration
- Size of the indoor environment (room size)
- Operating speed of the air cleaner
- Number of air cleaners placed in the indoor environment
- Saturation state of the filters in the air cleaner

Consult a qualified specialist to determine an effective and comprehensive indoor air quality strategy.

Caution: Intense concentration of pollutants may cause filters/cartridges to saturate or expire sooner than indicated by the control panel.

Chapter 2 – Setting Up

2.1 Unpacking

To unpack the IQAir system, open the top of the box and remove the square styrofoam pad which contains all accessories and product literature. Lay the box on its side, hold the system by the handle and pull it out of the box. Remove the plastic bag and foam belt. Keep the packaging for future transport and service needs.

IQAir Advanced Air Cleaning System

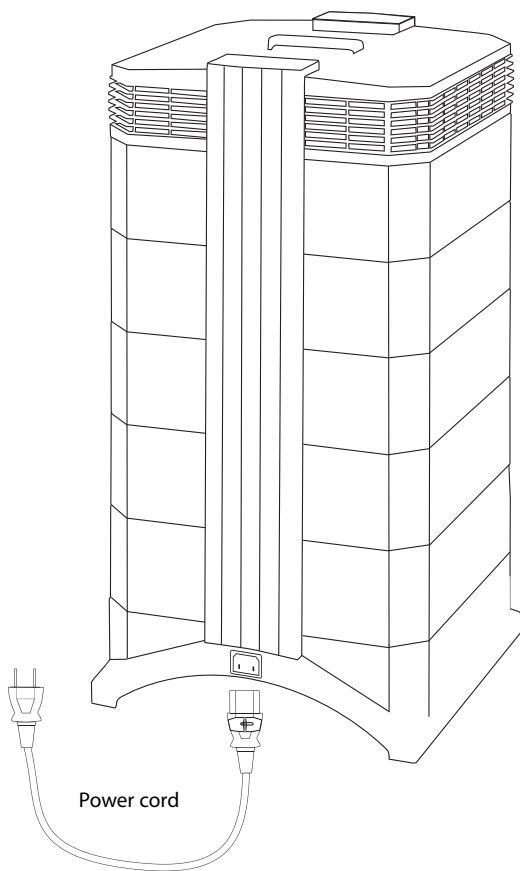

Four Post Filter Sleeves

Note: The sleeves are supplied inside the IQAir system. Pull the post filter sleeves over the cartridges before installing the cartridges in the air cleaner.

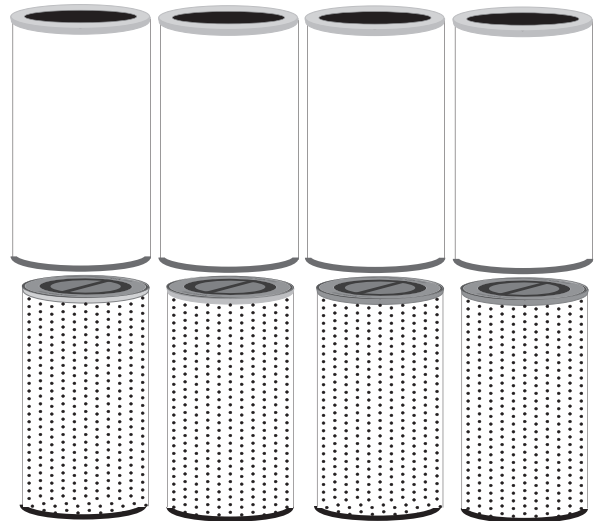

Four Gas Phase Filter Cartridges

Note: The gas phase filter cartridges are supplied in a separate box and must be installed before use.

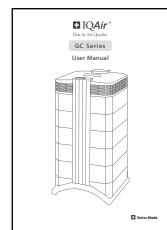

User Manual



GC User DVD

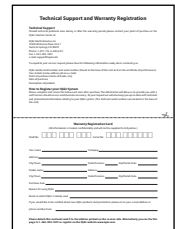

Technical Support / Warranty

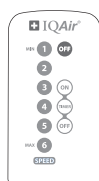

Remote Control Including Battery

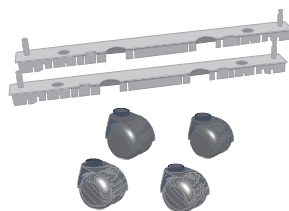

Set of Casters



Certificate of Performance

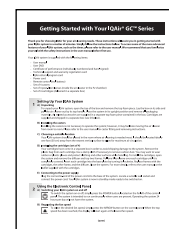

Getting Started Instructions

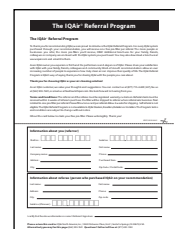

Referral Program (Free pre-filter!)

2.2 Choosing a Suitable Location

When choosing a suitable location for the IQAir system, keep the following considerations in mind:

- Choosing the most suitable room for the system will depend on where you would like the focus of the air cleaning efforts. Two main considerations are the time you spend in a particular room and the location of the main air pollution sources. As a general rule, the closer the system is located to the air pollution source, the better the air cleaning performance in the room.

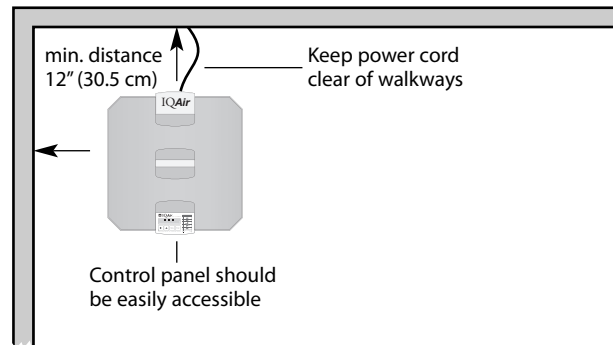

Although an air cleaning result may be achieved in adjacent rooms, the main air cleaning will take place in the room where the system is located. For the best air cleaning results in adjacent rooms, make sure that doors to these rooms are left wide open.

- For best performance, the system should be positioned at least 12 inches (30.5 cm) away from the nearest vertical surface, such as a wall or a cupboard. In general, the more centrally the system is positioned, the better the performance.
- Position the system close to a power outlet and make sure that the power cord is positioned in a way that it does not present an obstacle.
- Make sure that the system is positioned in such a way that the control panel is easily accessible.

2.3 Connecting to Power

1. Plug the connector end of the power cord into the recessed power inlet socket on the back of the system.
2. Plug the other end of the power cord into a power outlet or power strip.

Important: The only way to disconnect power completely is to unplug the power cord. If the system is disconnected from the power supply for more than one hour, the current day and timer will need to be reset.

Do not use the IQAir system when the power cord becomes damaged. The power cord may be replaced with an approved cord with a two-pole plug. Replacement cords are available from IQAir.

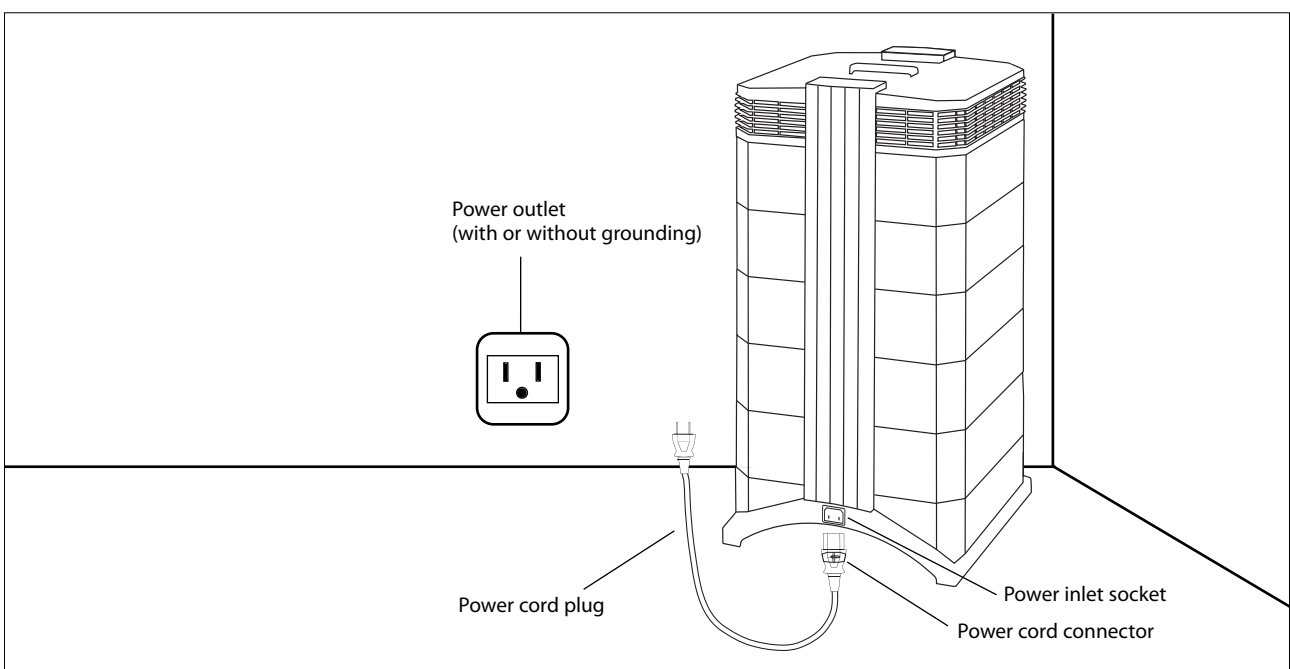

2.4 Fitting and Removing Casters

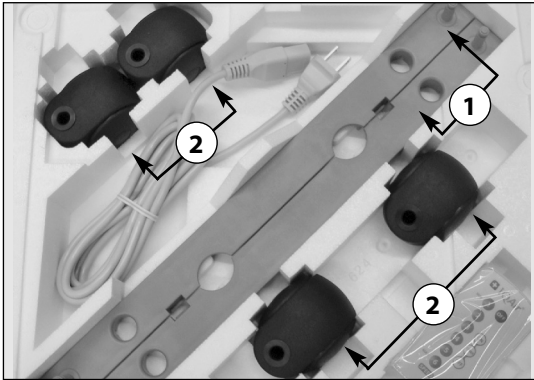

Attaching the supplied casters is optional. They make it easy to move the air purifier between rooms.

The caster kit consists of:

1. mounting rail (x 2)
2. casters (x 4)

For installation simply follow the below instructions:

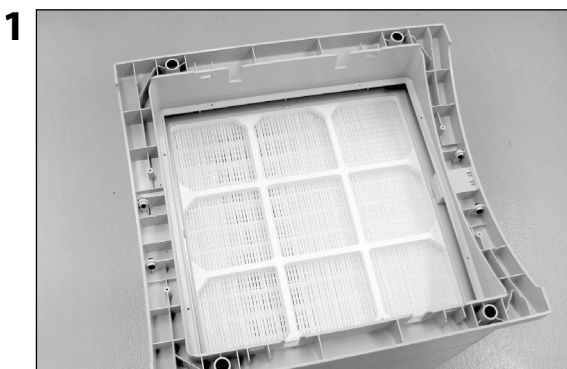

1 Turn the device upside down on a soft and clean surface.

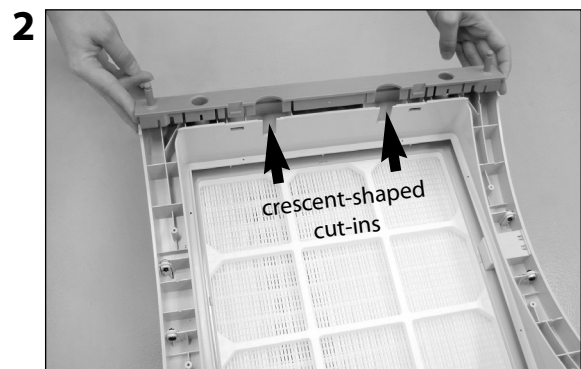

2 Place the mounting rail on the purifier's base so that the holes line up with the black connector pins on the base. The cut-ins should face the center of the unit.

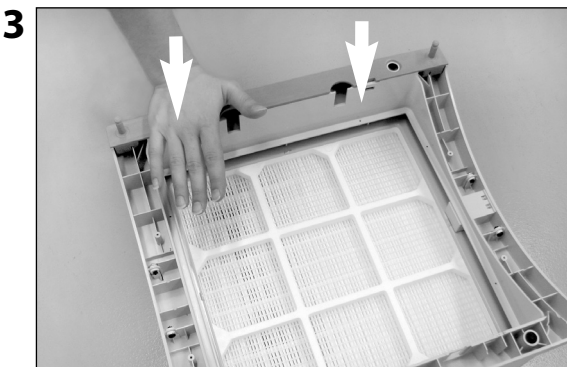

3 Press down until the mounting rail snaps into place. Repeat with second rail.



4 Place the caster onto caster pin.

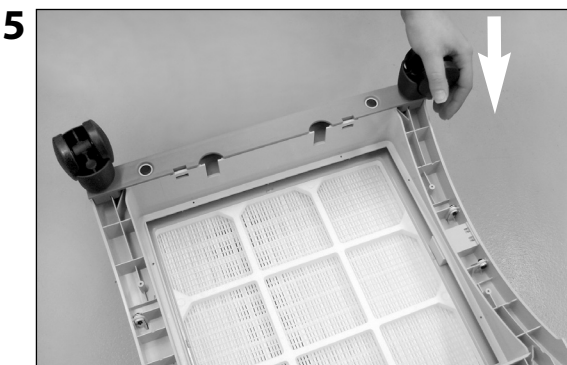

5 Press on caster, until it snaps into place. Repeat steps 4 and 5 with the remaining casters.



6 Ensure that each caster is securely fitted before placing the air purifier in its upright position onto the casters.

Removing Casters From Your IQAir® Air Purifier



Switch the device off.

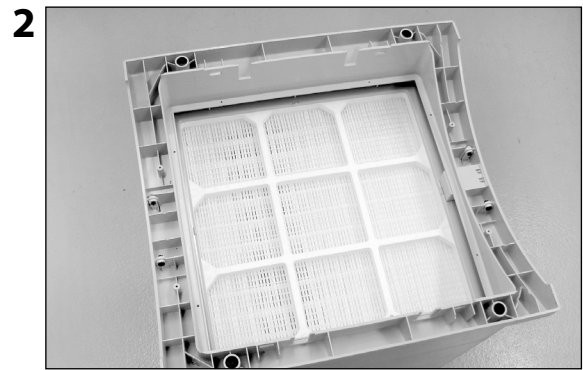

Turn the device upside down on a soft and clean area or surface.

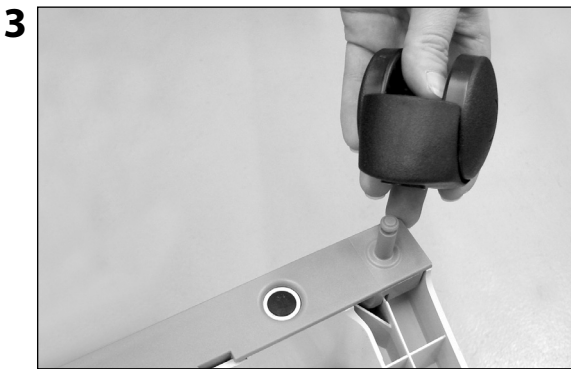

Remove each castor from the rail by pulling it straight off. The castor pins will be exposed.



There are two slotted tabs on each rail.

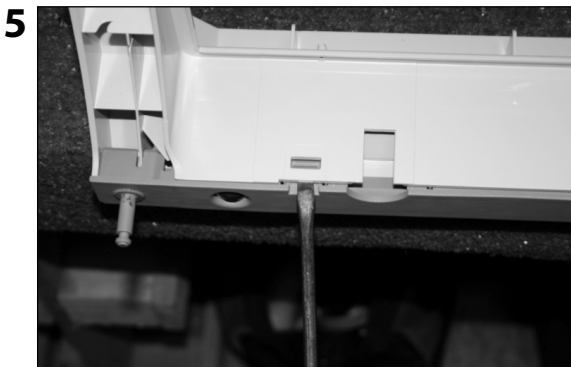

Using a flat-head screwdriver, press firmly into the slotted tab.

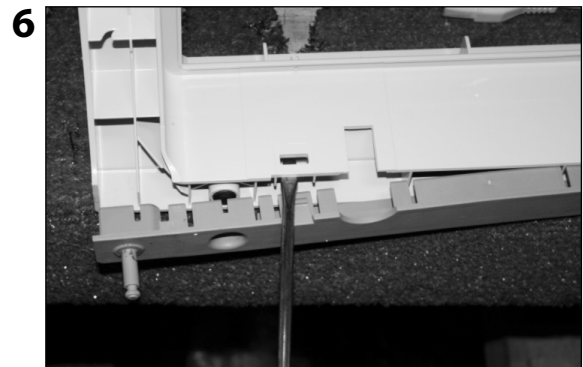

Use the screwdriver to gently loosen and lift the rail away from the base. Lift the rail out by hand. Repeat steps 5 and 6 for the second rail.

Chapter 3 – The IQAir® System's Components

3.1 Description of Housing Components

The IQAir system features a modular tower design in which all important filtration and air moving components are positioned vertically in-line, i.e. stacked on top of another. Air is drawn into the system at the base, and passes through several filter stages to be returned to the room via the diffuser on top of the system. The housing modules are held together by two locking arms.

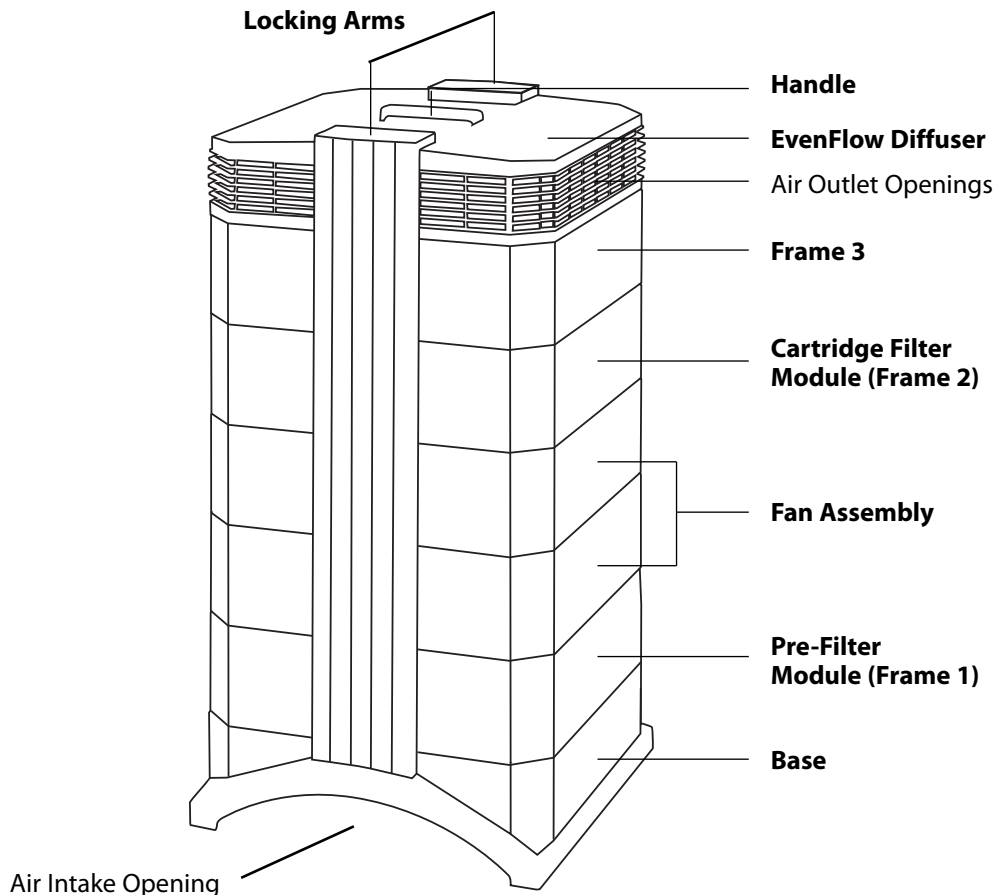

- The **base**, with its arched design, features air intake openings on two sides.
- The **pre-filter module** consists of frame 1 and the pre-filter which is secured inside the frame by four filter clamps.
- The **fan assembly** comprises two housing modules with the centrifugal fan inside.
- The **cartridge filter module** consists of frame 2 and a steel base plate in which the four gas phase filter cartridges are fixed by means of a bayonet locking system.
- The **frame 3** surrounds the gas phase cartridges and filter sleeves to where the diffuser starts.
- The **EvenFlow diffuser** contains omni-directional air outlet openings.
- The **handle** on top of the diffuser is designed for carrying the IQAir system.
- The **locking arms** hold the housing elements together. When opened, the locking arms allow easy access to all filters.

3.2 Description of Removable Components

The IQAir system features a modular housing design which enables the easy replacement of all filters in a matter of seconds. The illustration below shows all the removable components. For more details on how to replace filters, please refer to Chapter 6 – Replacing Filters.

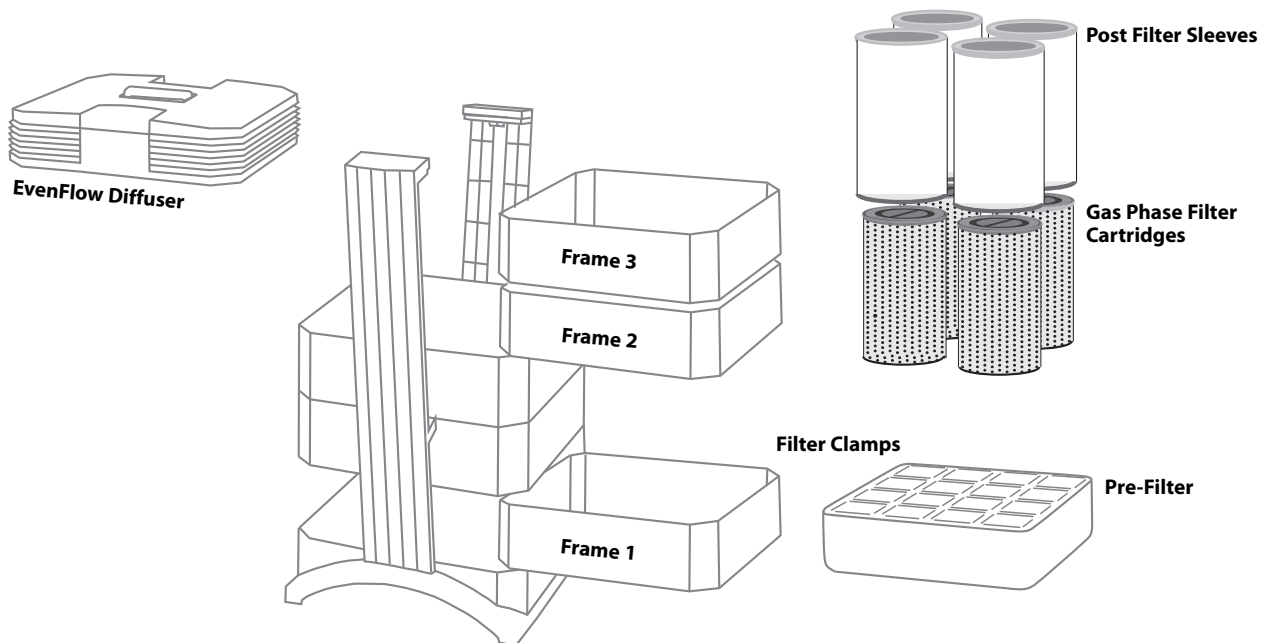

3.3 How the IQAir® System Works

- 1 Room air is drawn into the system via two arched openings at the base.
- 2 The air is drawn in through a high-efficiency pre-filter that removes most coarse and fine dust particles.
- 3 At the heart of the system, sandwiched between the filters, is a powerful centrifugal fan which generates the airflow.
- 4 The air is pushed through four cartridges that contain gas phase control media, which retains specific gaseous pollutants and odors.
- 5 Particulate post-filter sleeves hold back abrasion particles from the gas phase filter media.
- 6 Low turbulence, low velocity air is returned to the room via the EvenFlow diffuser.

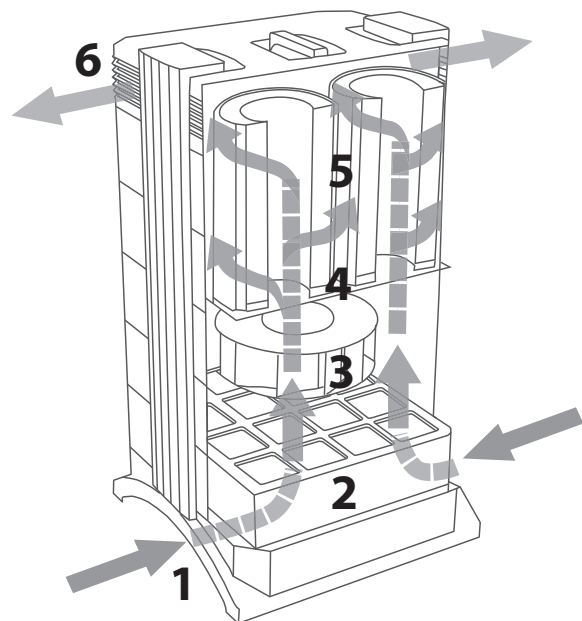

Chapter 4 – Using the Control Panel

The IQAir system is operated and controlled via the electronic control panel which is located at the top of the front locking arm.

Several operations can be completed via the electronic control panel:

- Switching the system on and off
- Controlling the fan speed and corresponding air delivery rate
- Checking the remaining filter life of the individual filters
- Setting the automatic timer
- Resetting the Filter Life Monitor after replacing a filter
- Locking the control panel to avoid tampering with the system's settings
- Choosing the desired display language
- Setting the day & time

4.1 Description of Control Panel

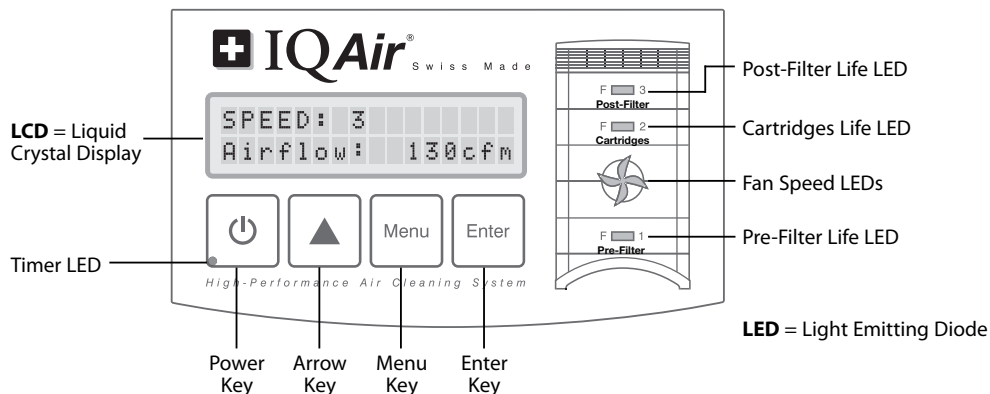

LCD Display

The 2-line LCD displays important information about the system's settings.

In standby mode, (not running) without the timer activated, the first line displays the IQAir model name and the word "Standby" is displayed on the second line. If the timer is activated, the current day and time, and the next programmed start and stop time will be displayed instead.



Main window: Standby mode



Main window: On mode

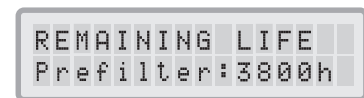

Menu window: Filter Life Monitor

Note: Airflow and remaining filter life may be different on actual air cleaner.

If the IQAir system is running and the timer is not activated, the first line displays the current speed setting and the second line displays the corresponding air delivery rate of the system; however, when the timer is activated, the current programmed start and stop times (Timer ON period) will be displayed on the second line.

4.1.1 Description of Control Panel Keys

Power Key

The **Power** key switches the IQAir system on and off. When the system is switched off, the fan stops to run, but the system will remain connected to the power supply (standby mode). The standby mode allows for automatic timer start-up. In the standby mode, the different menu functions can be accessed.

Tip: In a menu window, the **Power** key also serves as a quick exit key to return to the main display window.

Arrow (▲) Key

When the system is switched on, the ▲ key allows the adjustment of the fan speed. In the enter mode, indicated by the appearance of a black flashing cursor (see "Enter Key" below), the ▲ key is used to modify the selected setting in the display window. Confirmed with the **Enter** key, the enter mode is automatically terminated. The LCD will then display the current menu settings for another 15 seconds before reverting to the main window display.

 **Menu Key**

The **Menu** key allows access to any one of ten menus. Pressing the **Menu** key once allows access to the first menu function. Pressing the **Menu** key twice allows access to the second menu function, and so on. If no key is pressed for 15 seconds in a menu window, the display will revert to the main display window. **Tip:** If you are in a menu window and would like to remain in the window for more than 15 seconds, keep the ▲ key depressed.

 **Enter Key**

The **Enter** key, if pressed for 3 seconds, allows the modification of a setting. The enter mode is indicated by a flashing cursor on the modifiable setting. Pressing the **Enter** key again will save any entry and move the cursor to the next modifiable item in the display window. When the last modifiable choice in a window is confirmed with the **Enter** key, the enter mode is automatically terminated and the new settings are saved.

Filter Life LEDs

Whenever the system is on, the color of the filter life LEDs (light emitting diodes) indicates the state of the individual filters in the system. **Note:** The positions of the filter life LEDs on the control panel correspond to the actual positions of the filters within the system.

The filter life indicator LEDs signal four possible stages in the life of the filter:

- 1. **Green:** The filter is still within 80% of its estimated life span.
- 2. **Orange:** The filter is approaching the last 20% of its estimated life span.
- 3. **Red:** The filter has reached the end of its estimated life span.
- 4. **Red (blinking):** The filter has passed its estimated life span and should be replaced immediately. The IQAir system’s effectiveness is likely to have been reduced dramatically, either due to a reduction in airflow (particle filters are clogged) or a reduction in filter efficiency (gas phase filter is saturated).

Fan Speed LEDs

These LEDs simulate the fan speed through the frequency of their rotation. The faster the rotation of the fan speed LEDs, the faster the actual fan speed of the system.

4.2 Control Panel Locking Function

The control panel keys can be locked to avoid tampering with the settings. To lock or unlock the control panel keys, both the **Menu** and the **Enter** key have to be pressed down simultaneously for 3 seconds. The activated locking function is indicated with a star symbol in the control panel display. The locking function is not cancelled by disrupting the power supply. The remote control will still operate the IQAir system when the locking function is activated, only the control panel keys are locked.

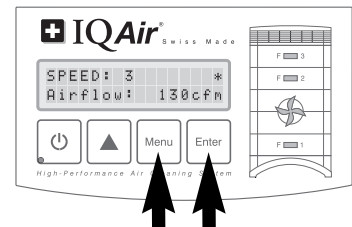

4.3 Fan Speed and Air Delivery

The IQAir system can be set to run at six different fan speeds which correspond to six different airflow rates. Speed 1 is the lowest speed. Speed 6 the highest fan speed. The higher the fan speed, the more room air will be filtered by the system. The high fan speed settings provide additional air cleaning power to deal with situations of elevated pollution levels.

To allow better evaluation of the system’s performance at different fan speeds, the standard display window shows not only the fan speed, but also the air delivery rate (airflow). The displayed airflow is factory preset and is not measured by the system itself. (When Timer is activated, the display will change. Refer to section 4.4.6.)

4.3.1 Regulating Fan Speed

- 1. When the IQAir system is switched off (standby mode), the first line of the LCD display shows the model name. To switch the system on, press the **Power** key on the far left of the control panel.
- 2. The LCD now displays the fan speed and the corresponding airflow rate. **Note:** The system starts at the fan speed at which it was running when it was last used.
- 3. To change the fan speed, press the ▲ key.

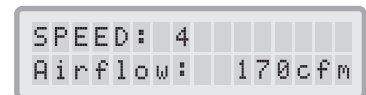
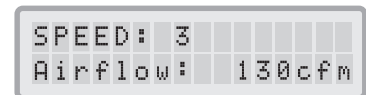

4.3.2 Air Exchange Rates in Differently Sized Rooms

Any air cleaner can only be effective if it filters a sufficient amount of air in an indoor environment. For general air cleaning purposes, the IQAir system should be able to filter the room air volume at least twice every hour on the set fan speed to achieve a significant air quality improvement. If the intensity of the pollution source is high or a high degree of purification is needed, more air changes may become necessary. In order to achieve the desired number of air changes, more than one air cleaner may be required, or a HVAC filtration system should be considered.

The number of air changes that are necessary to attain a certain level of indoor air quality will depend on a variety of factors, including:

- **Intensity of air pollution source:** The higher the rate at which air pollutants are produced or enter the indoor environment, the higher the air cleaning rate in the room needs to be.
- **Filtration efficiency for specific air pollutants:** The lower the filtration efficiency for certain pollutants, the more air changes are required to reduce these pollutants.
- **Desired improvement in air quality:** The higher the desired improvement in air quality, the more air changes are required.

The number of air changes per hour (ACH) produced by an IQAir system in a specific environment are calculated as follows:

$$\frac{\text{hourly air delivery of the IQAir system (cfm = cubic feet per minute) } \times 60}{\text{air volume of the room (cu.ft.) (L } \times \text{ W } \times \text{ H)}} = \text{air changes per hour (ACH)}$$

Note: The air delivery rates of the IQAir system at the various fan speeds settings are listed on the Technical Specifications sheet found at the back of this manual or visit www.iqair.com/support.

Example calculation: A room with the dimensions of 13 x 14 x 8 ft. has an air volume of 1,456 cu.ft. With an air delivery rate of 140 cfm, the room air volume will be circulated over 5.7 times per hour by the IQAir system (140 cfm = 140 x 60 min = 8,400 cu.ft/h; 8,400 cu.ft/h ÷ 1,456 cu.ft = 5.77 ACH).

4.4 Using the Menu Functions

The IQAir control panel offers a choice of several menu options which allow access to the advanced features of the system. In total there are ten active menu functions. The functions can be accessed in standby or running mode.

4.4.1 Menu Overview

Pressing the **Menu** key accesses the menu functions in the following order:

1. Filter Life Monitor (Remaining Life)

Allows the viewing of the remaining filter life of the individual filters within the system.

REMAINING LIFE
Prefilter: 400h

2. Setting the Timer ON period (Auto Timer: ON)

Allows to activate the timer and set the Timer ON period. Time is displayed in a 24 hrs. clock, military time.

AUTO TIMER: OFF
00:00 → 00:00

3. Automatic Timer (Day-of-the-Week-Timer)

Allows to deactivate or deactivate the Timer ON period on particular days of the week.

Mo Tu W T F S Su
* * * * * * *

4. Timer ON Speed Selection

Allows to set the fan speed for the Timer ON period.

Timer ON Speed:
4

5. Timer OFF Speed Selection

Allows to set the fan speed outside the Timer ON period. Refer to section 4.4.5.

Timer OFF Speed:
0

6. Time & Day Setting

Allows to set the current time and day setting.

TIME 00:00
DAY Mo

7. Filter Life Reset

Allows the resetting of the filter life counter after replacing a filter.



8. Airflow Units

Allows to switch the airflow units between cfm (cubic feet per minute) and m3/h (cubic meters per hour).



9. Language

Allows to switch the display language.



10. Service Access

This menu is designed for factory access only.



4.4.2 Filter Life Monitor

The IQAir system is equipped with an electronic Filter Life Monitor that calculates the remaining life of the system's filters. Thanks to the Filter Life Monitor, the user does not have to guess when filters need to be replaced or replace them at fixed intervals (which rarely correspond to the actual amount of use). The Filter Life Monitor keeps track of the most important factors affecting the life of the individual filters. The Filter Life Monitor display shows the remaining life of each individual filter at any given time at the selected fan speed.

1. To reach the Filter Life Monitor display from the main display window, press the **Menu** key once. The remaining life of the Pre-Filter will appear.
2. Press the **▲** key to view the remaining life of the other filters in the system.
3. The remaining life of the filters is expressed in hours of operation at the current speed setting. Filter Life will adjust whenever the fan speed is changed. If the filter is beyond its useful life, a negative number will be displayed.

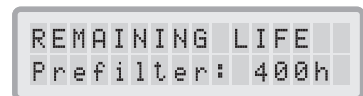

How the Filter Life Monitor Works

The basis for calculating the remaining filter life is the already elapsed operation time at the set fan speed. This input is compared with an internal memory bank which contains information about the different filters' lives under specific conditions of use.

The Filter Life Monitor makes a calculation of the remaining filter life, taking into account not only past use of the system, but also likely future use. As reference for future use, the Filter Life Monitor uses the fan speed which is set at the time.

The relationship between the current fan speed and the remaining filter life displayed can be expressed as follows: The higher the current fan speed setting, the shorter the displayed remaining filter life.

4.4.3 Setting the Auto Timer

The Auto Timer Menu allows the setting of a Timer ON period, which is defined by a START time and a STOP time. For the Timer ON period, a fan speed can be selected in the Timer ON Fan Speed Menu (see 4.4.5). The time outside the Timer ON period is defined as the Timer OFF period for which the air cleaner can be switched off or for which a different fan speed can be selected in the Timer OFF Fan Speed Menu (see 4.4.5).

The timer status field indicates whether the timer function is enabled or disabled (on or off). Use the time status field to quickly enable/disable the timer e.g. for holiday.

1. To reach the Auto Timer Menu from the main display window, press the **Menu** key twice.
2. Press and hold the **Enter** key until the cursor starts to flash.
3. Press the **▲** key one time to activate the timer.
Note: If the START and STOP times are identical, the timer cannot be activated.
Note: The time is displayed in a 24 hrs. clock, military time.
4. Press the **Enter** key to save the timer status setting and to proceed to the START time.
5. Select the desired START hour by pressing the **▲** key.
6. Press the **Enter** key to save the START hour and to proceed to the minute setting.
7. Select the desired START minute setting by pressing the **▲** key.
Note: The minute settings can only be set in five minute increments.
8. Press the **Enter** key to save the minute setting, save the START time and to proceed to the STOP time setting.
9. Select the desired STOP hour by pressing the **▲** key.
10. Press the **Enter** key to save the STOP hour and to proceed to the minute setting.
11. Select the desired STOP minute setting by pressing the **▲** key.
12. Press the **Enter** key to save the STOP minute setting, save the STOP time and to exit the enter mode.

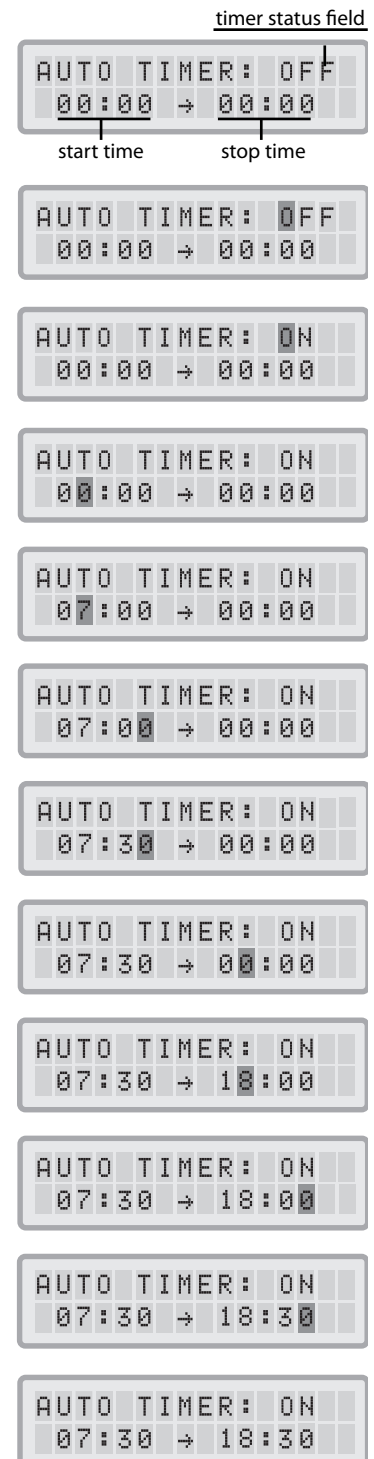

Note: The times are displayed in a 24-hour clock.

4.4.4 Day-of-the-Week Timer

The Day-of-the-Week Timer allows the deactivation of the Timer ON period on certain days of the week. In its default setting the Timer ON period is enabled on all seven days of the week. This is indicated by stars below the abbreviations of the days. On days without a star the air cleaner will be running at the speed which is set in the Timer OFF Speed Selection Menu (see 4.4.5).

Note: At least one day of the week must be activated with a star to enable the Auto Timer. If the timer is disabled on all days of the week, the timer status field in the Auto Timer Menu will switch to OFF and the timer will be disabled.

1. To reach the Day-of-the-Week Timer Menu from the main display window, press the **Menu** key three times.
2. Press and hold the **Enter** key until the cursor appears.
3. Press the **▲** key to activate (star) or deactivate (no star) the Timer ON period on a particular day. Press the **Enter** key to proceed to the next day.
4. Repeat the same procedure until the timer has been activated/deactivated on the desired days. The final **Enter** command exits the enter mode.

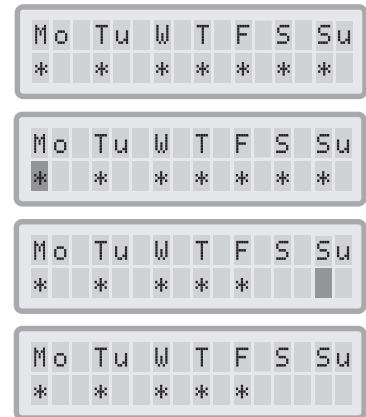

4.4.5 Timer ON/OFF Fan Speed Selection Menu

The Timer ON/OFF Fan Speed Selection Menus allow the setting of two different fan speeds for two different time periods (referred to as Timer ON period and Timer OFF period). For the Timer ON period you can select fan speeds 1 to 6. For the Timer OFF period, you can select fan speeds 0 (OFF) to 6.





1. To reach the Timer ON Fan Speed Selection Menu from the main display window, press the **Menu** key four times.
2. Press and hold the **Enter** key until the black cursor appears.
3. Press the **▲** key to select the desired speed for the Timer ON period.
4. Press the **Enter** key to confirm the chosen speed and to exit the enter mode.
5. To set the Timer OFF period fan speed, press the **Menu** key one more time. Press and hold the **Enter** key until the black cursor appears and adjust the Timer OFF fan speed as above. The final **Enter** command saves the selection and exits the enter mode.





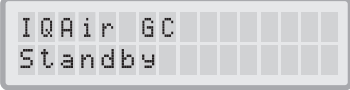

4.4.6 Timer Information in the Control Panel

The IQAir control panel shows the timer status without the need to access the Timer related menus.

Timer Deactivated

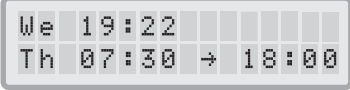
<p>System on Standby: The first line shows the model name and the second line shows the word “Standby”. The Timer LED is red when the timer is not set.</p>	<p>Display’s Main Window</p>	<p>Timer LED</p>
		
	<ul style="list-style-type: none"> • System is on standby • Timer is deactivated 	
<p>System Running: The first line shows the fan speed and the second line shows the airflow. The Timer LED is off.</p>		
	<ul style="list-style-type: none"> • System is running • Timer is deactivated 	

Timer Activated

<p>System on Standby: The first line shows the current day and time and the second line shows the next time the system will turn on. The Timer LED is green.</p>	<p>Display’s Main Window</p>	<p>Timer LED</p>
		
	<ul style="list-style-type: none"> • System is on standby • Timer activated to start on Thursday 	
<p>System Running: The first line shows the fan speed and the second line shows the current Timer ON period (start and stop times). The Timer LED is green.</p>		
	<ul style="list-style-type: none"> • System is running • Timer is activated 	

4.4.7 Time & Day Setting

When the IQAir system is first connected to the power, the day and time displayed will be incorrect and will have to be set for the timer function to work properly. Once the current day and time are set, they will only need to be reset if the system is disconnected from the power supply for more than an hour.

1. To access the Time & Day Menu from the main display window, press the **Menu** key six times.
2. Press and hold the **Enter** key until the cursor starts to flash.
3. Select the hour by pressing the **▲** key.
4. Press the **Enter** key to save the hour setting and to proceed to the minute setting.
5. Select the minutes by pressing the **▲** key.
6. Press the **Enter** key to save the minute setting and to proceed to the day setting.
7. Select the day of the week by pressing the **▲** key.
8. Press the **Enter** key to save the day setting and to exit the enter mode.
9. Press the **Power** key to return to the main display. **Note:** The display will automatically return to the main window if no key is pressed for 15 seconds.



4.4.8 Filter Life Reset (New Filter)

The Filter Life Reset function allows the Filter Life Monitor to be reset after a new filter has been inserted. As a result, the appropriate filter life LED on the control panel will be reset to green and the hour count in the Filter Life Reset display will be reset to the full life span of the new filter. **Note:** Resetting the Filter Life Monitor will also cancel the “Replace Filter” warning from the main display window.

Important: To safeguard against inadvertently resetting the life of the wrong filter, the filter selection needs to be confirmed twice by pressing the **Enter** key. Refer to steps 4 and 5 below. If the wrong filter has been selected, or if you wish to exit the Enter mode, press the **Menu** key. This will leave the Filter Life Reset unaffected and return you to the Main display. **Note:** If no key is pressed for 15 seconds in a menu window, the display will revert to the main display window.

1. To reach the Filter Life Reset function from the main display window, press the **Menu** key seven times.
2. Press and hold the **Enter** key until the flashing cursor appears. The first filter selection to appear is the Pre-Filter. Release the **Enter** key.
3. Press the **▲** key to select the filter that has been replaced. The Filter Life LED for the appropriate filter is currently flashing red.
4. Press the **Enter** key to confirm that the selected filter has been replaced.
5. To re-confirm the filter change, press the **Enter** key. To exit the Filter Life Reset window, press the **Menu** key.
6. Upon successful reset of the filter life, the new remaining filter life (taking the currently selected fan speed into account) will be displayed, and the filter LED light on the control panel will change from red to green.

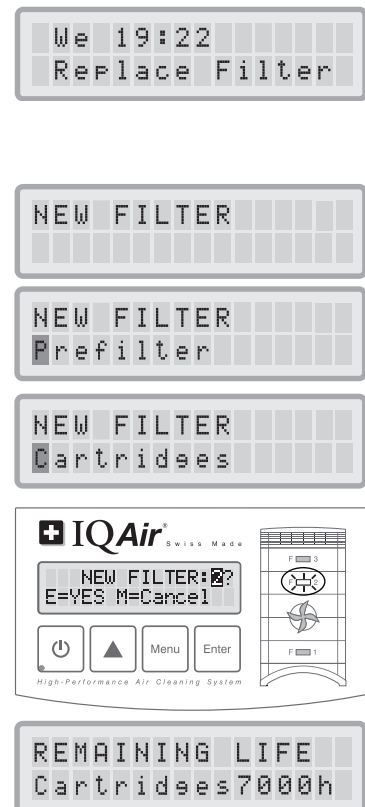

4.4.9 Changing the Airflow Units

1. You can reach the Airflow Units **Menu** by pressing the Menu key eight times.
2. You can change the air volume units which are displayed from cubic feet per minute (cfm) to cubic meters per hour (m³/h), or vice versa, by pressing the **Enter** key for three seconds either when the unit is switched on or in standby mode.
3. When the first character of the airflow units starts to flash, press the ▲ key once to change the units.
4. Press the **Enter** key to confirm the air volume unit change. Until modified again, the airflow rate will now be displayed in the newly selected units.
Note: The air delivery (airflow units) displayed in this manual are examples only and will vary according to model.

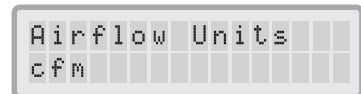

Airflow Units
cfm



Airflow Units
cfm

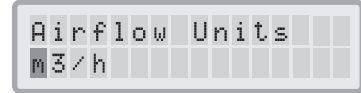

Airflow Units
m³/h

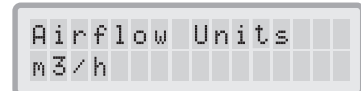

Airflow Units
m³/h

4.4.10 Language Setting

The Language Menu allows you to change the IQAir system's display language. The languages from which you can choose will depend on the model and the country of purchase.

1. To reach the Language Menu from the main display window, press the **Menu** key nine times. The current language is displayed.
2. To change the display language, press and hold the **Enter** key until the cursor starts to flash.
3. Use the ▲ key to scroll through the display language options.
4. Press the **Enter** key to save the desired display language and to exit the enter mode.



LANGUAGE
English



LANGUAGE
English

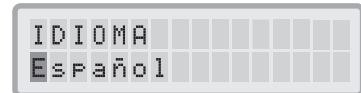

IDIOMA
Español



IDIOMA
Español

Chapter 5 – Using the Remote Control

In addition to the control panel, the IQAir system can be controlled by using the handheld remote control.

The remote control can be used to:

- Switch the system on and off
- Select the desired fan speed
- Activate and deactivate the timer function (Note: Start and stop times can only be set and changed directly on the system's control panel)

5.1 Remote Control Elements and Functions

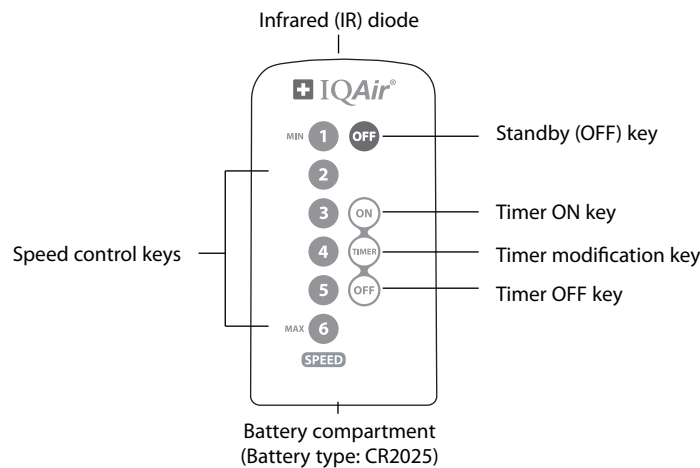

Switching the System On and Off

To switch the IQAir system on with the remote control, press any one of the **speed control** keys marked with 1 through 6. The system will still start at the fan speed of the pressed key. To switch the IQAir system off, press the **OFF** key.

Switching the Timer On and Off

If start and stop times have been set in the Auto Timer Menu, it is possible to switch the timer on and off with the remote control. To switch the timer on, press the **Timer Modification** key and then the **Timer ON** key. To switch the timer off, press the **Timer Modification** key and then the **Timer OFF** key.

5.2 Getting the Best Transmission Results

The IR (infrared) receiver of the IQAir system is positioned underneath the control panel cover. In order to get the best signal transmission, the remote control should be pointed at the control panel when a remote command is being carried out. Alternatively, the remote control should be pointed at a surface like a wall, ceiling or window, from which the signal can bounce off in a right angle (90°) to the electronic control panel.

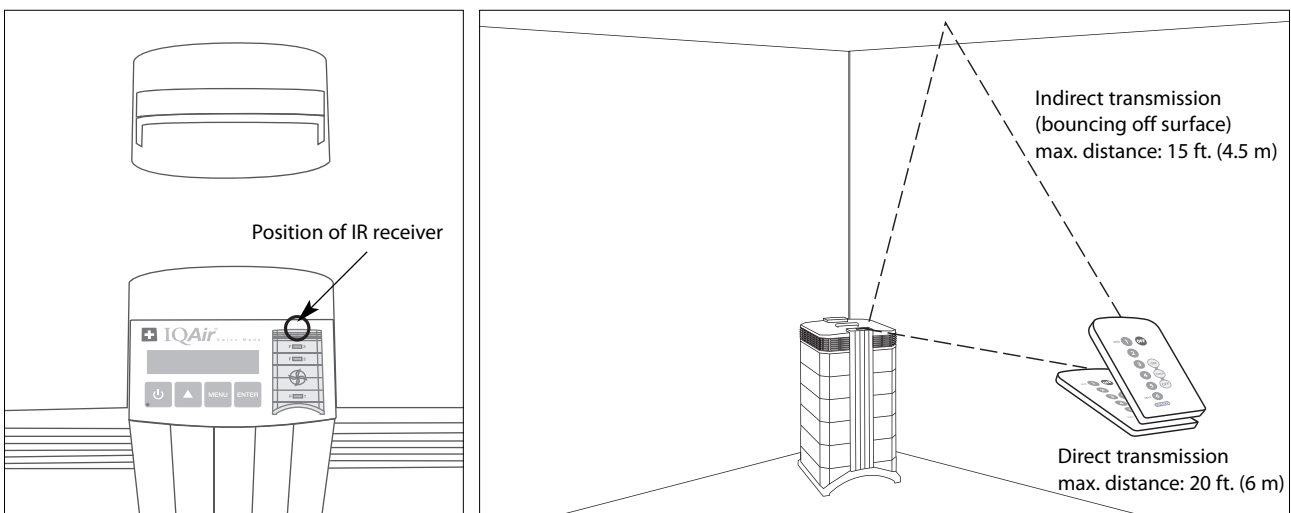

5.3 Replacing the Battery of the Remote Control

When the battery becomes weak, the transmission results will deteriorate and the battery should be replaced. The remote control requires one CR2025 battery. The battery compartment is located at the bottom end of the remote control.

To open the battery compartment, press the small lever to the side and slide the battery compartment out. Remove the used battery and insert the new battery.

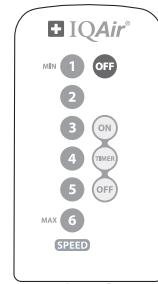

Battery compartment
(Battery type: CR2025)



Chapter 6 – Replacing Filters

The IQAir system is equipped with a Filter Life Monitor which is designed to assist you in determining when a filter needs to be replaced. If the air pollution in your environment is very high, there is a possibility that the filter may not be effective throughout the displayed life time and may have to be replaced earlier than indicated by the Filter Life Monitor.

For this reason, it is important to look out for the signs of expired filters and replace filters earlier if necessary. The main signs are:

- Increased operating noise
- Decreased airflow
- Clogged filters
- Increased odor presence

Note: After a filter has been replaced, the filter life must be reset in the control panel. Refer to section 4.4.8.

6.1 Location of the Filters

The IQAir system features a modular housing design which enables easy replacement of all filters in a matter of minutes. The illustration of the IQAir system on the control panel shows the positions of the individual filters. These positions correspond to the actual positions of the filters within the system.

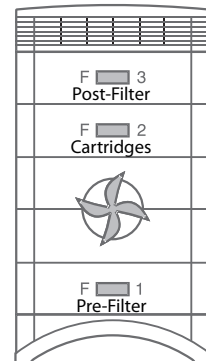

Filter positions as shown on
the control panel

6.2 Ordering Replacement Filters

To order replacement filters, please contact your local IQAir authorized dealer. To locate the dealer nearest to you, call 877-400-1050 or visit www.iqair.com.

Please order your replacement filters by quoting the appropriate article numbers stated below:

IQAir GC VOC:	Pre-Filter	Art. No. 102 10 12 00
	VOC filter cartridge	Art. No. 102 40 10 00
	Post-Filter sleeve set	Art. No. 102 50 10 00
IQAir GC MultiGas:	Pre-Filter	Art. No. 102 10 12 00
	MultiGas filter cartridge	Art. No. 102 40 16 00
	Post-Filter sleeve set	Art. No. 102 50 10 00
IQAir GC Chemisorber:	Pre-Filter	Art. No. 102 10 12 00
	Chemisorber filter cartridge	Art. No. 102 40 18 00
	Post-Filter sleeve set	Art. No. 102 50 10 00
IQAir GC AM:	Pre-Filter	Art. No. 102 10 12 00
	AM filter cartridge	Art. No. 102 40 14 00
	Post-Filter sleeve set	Art. No. 102 50 10 00

6.3 Opening and Closing the Housing

The stacked housing elements are held together by two locking arms that latch into the diffuser. To open the system, follow the steps below.

1. Disconnect the IQAir system from the power supply before attempting to open the system.
2. Press the first locking arm outward, using both thumbs as shown. Press just hard enough to release the arm from its snap-in position in the diffuser. Disengage the other arm in the same way.
3. Pull both locking arms evenly outwards until they snap into place and remain open. Access to all filter elements is now possible (to change a specific filter, refer to the appropriate section below).
4. To close the housing, simply push the locking arms inwards simultaneously until they snap back into the housing.

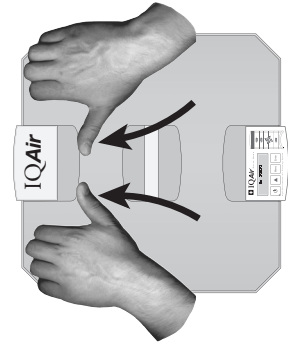

Opening

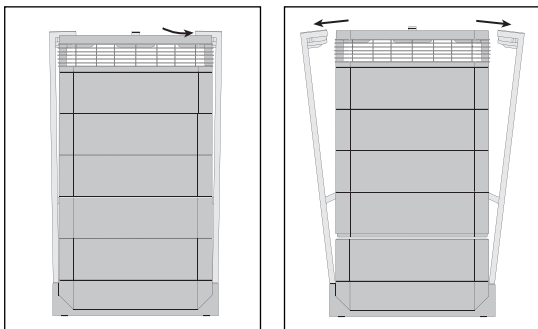

Closing

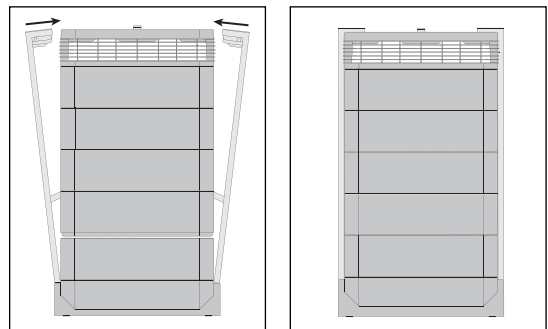

6.3.1 Troubleshooting When Closing the Housing

If the IQAir system does not close properly, the upper part of the system may be offset against the lower part. To solve this problem, simply open both locking arms again, ensure the housing is aligned, and push both locking arms in simultaneously.

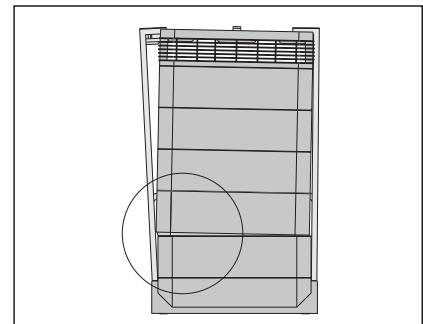

6.4 Replacing the Pre-Filter (F1)

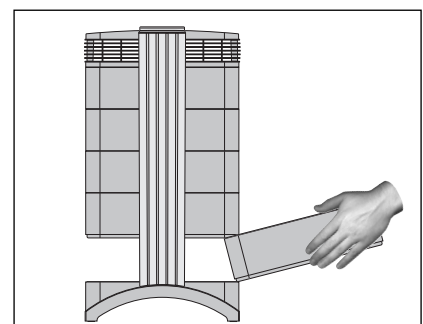
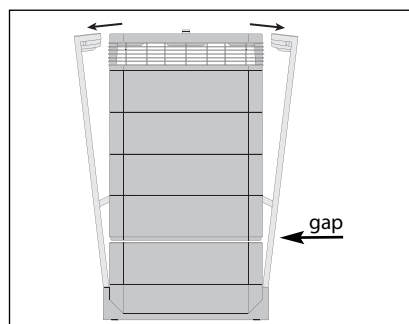
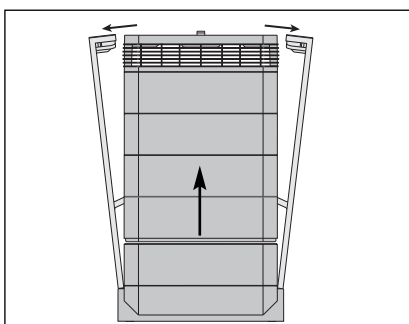

1. Open the locking arms, making sure they are fully extended outward. For details, refer to the section 6.3.
2. Opening the arms will cause the upper part of the housing to separate from frame 1. This will leave a narrow gap.
3. Keeping the locking arms open, place your hands on opposite sides of frame 1, lift it slightly and pull it out slowly. As the frame is withdrawn, tilt it progressively upward to remove it completely.

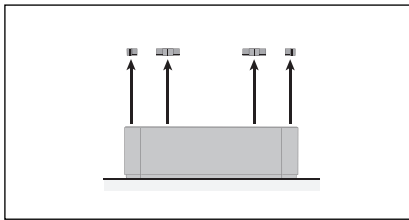

4. Remove the filter clamps that secure the filter in the frame by pulling these out of the sliding grooves.

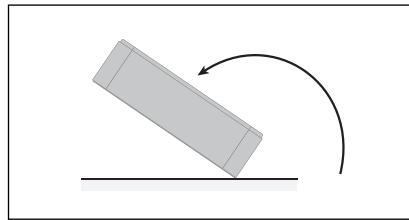

5. Turn the frame over so it is upside down.

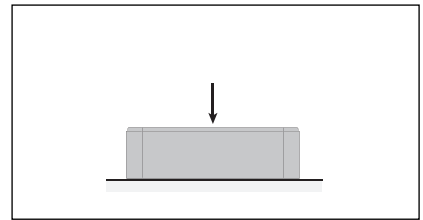

6. With the palm of the hand, press down on the filter and loosen the frame.

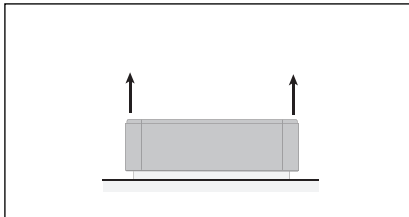

7. Lift the frame from the filter.

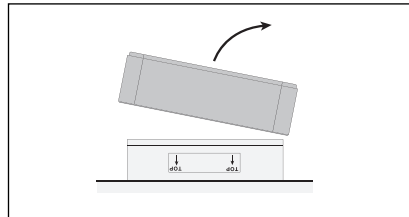

8. Dispose of the used filter by placing it into the plastic bag in which the new filter is supplied (see section 6.6).

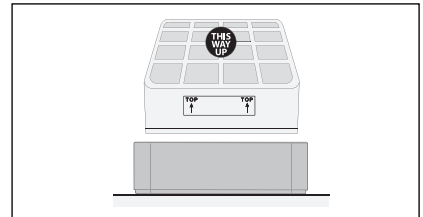

9. Turn the frame over (right side up again) and insert the new filter. Ensure that the arrows on the filter label point upward.

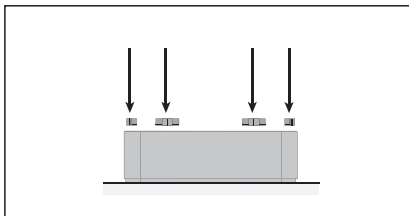

10. Make sure that the filter is inserted all the way into the frame. Insert the clamps into the sliding grooves inside the frame and push them down, securing the filter into place.

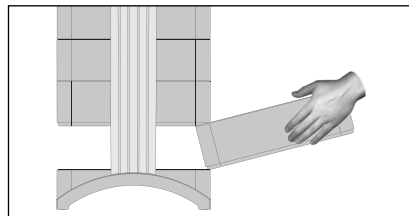

11. To reinsert frame 1, tilt it upwards at an angle while progressively pushing the frame back into the housing. For details on how to close the housing, please refer to section 6.3.



12. After a filter has been replaced, the Filter Life Monitor must be reset from the control panel (see section 4.4.8).

6.5 Replacing the Gas Phase Filter Cartridges and Post-Filter Sleeves (F2)

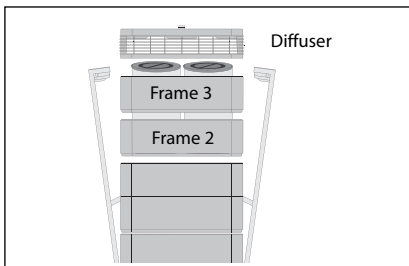

1. Open the locking arms, remove the diffuser and frame 3.

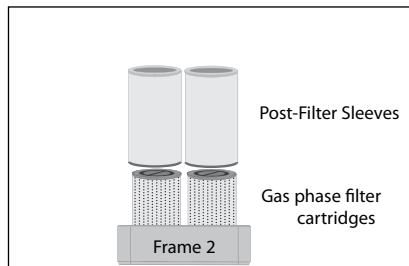

2. Frame 2 contains the four gas phase filter cartridges with the four Post-Filter Sleeves. Remove frame 2 with the cartridges.

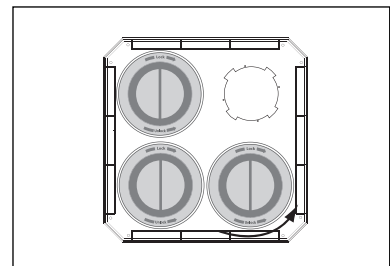

3. To remove the cartridges, twist each cartridge counter clockwise as far as it will go. It can then be lifted out of the base plate by hand (disposal see 6.6).

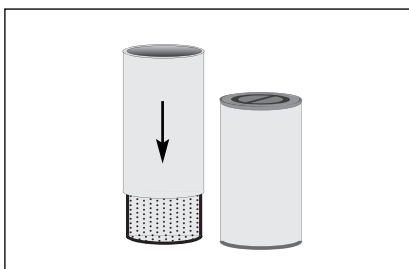

4. Pull a new filter sleeve over each new cartridge until it is completely covered.

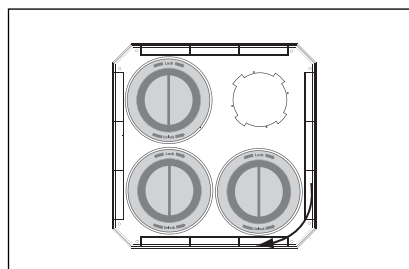

5. Insert the new cartridges in the base plate by turning the cartridge clockwise. Finally check that each cartridge is well secured in the base plate.

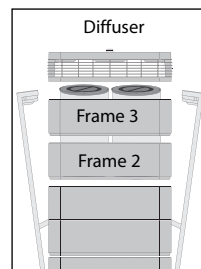

6. Replace frame 2 with the cartridges, the other frame, and the diffuser. Close the device by pressing both arms together. Reset filter life (refer to section 4.4.8).

Important: Black dust from cartridges can stain. Wear rubber or plastic gloves and protect clothing and other surfaces while handling.

6.6 Discarding Used Filters

Used filters can normally be put into the regular household trash for disposal. If the system may have been exposed to potentially hazardous substances, the filters may have to be disposed of as hazardous waste. Please refer to local regulations and laws for proper disposal.

Chapter 7 – Maintenance

7.1 Cleaning the Housing

- Unplug the IQAir system before attempting to clean it.
- Use a soft and clean cloth for cleaning.
- For water soluble stains, use a window cleaning fluid.
- For the removal of tough, non-water soluble stains, use a silicon spray.
- Do **not** use any solvents or any organic cleaning fluids.

7.2 Maintenance-Free Fan

The IQAir system is equipped with a maintenance-free fan motor.

7.3 Technical Support and Repairs

Should technical issues arise during or after the warranty period, please contact your point of purchase or call IQAir Technical Support at 888-560-1020 (toll free). You may also visit our Support Center at www.iqair.com/support where you can find answers to most frequently asked questions (FAQs) or contact us with your inquiry.

To expedite your service request, please have the following information ready when contacting us:

1. IQAir model, shell number and serial number (found at the base of the unit and on the certificate of performance)
2. Your details (name, address, phone number, e-mail)
3. Point of purchase (name of dealer, city)
4. Date of purchase
5. Description of issue

Refer to the technical support and warranty registration card included with your air cleaner literature for more details.

7.4 IQAir® Warranty

Your IQAir GC system comes with a limited warranty of:

- 1 year on parts and labor (commercial use)
- 5 years on parts and labor (residential use)

The warranty excludes filters. Please complete and return the warranty registration card soon after purchase or register online at www.iqair.com/support. The information will allow us to provide you with a swift service should service work become necessary.

Refer to the warranty information card included with your air cleaner literature for more details.

Chapter 8 – IQAir® Optional Accessories

IQAir advanced air cleaning systems can be complimented with a range of special IQAir accessories. Ask your authorized IQAir® dealer for details.

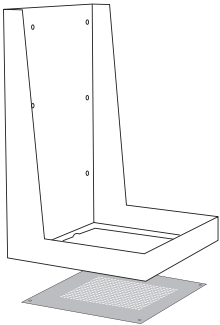

VMF™
Powder-coated stainless-steel wall bracket for the secure wall-mounting of the IQAir system where floor space is limited.

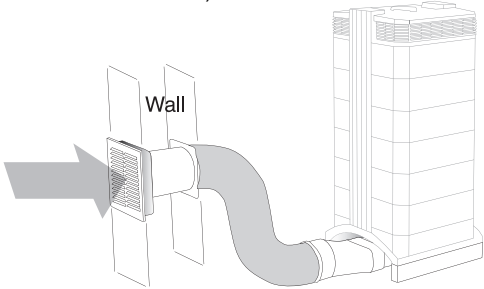

InFlow™
Complete ducting adapter kit for the creation of positive pressure (if placed within the room) and negative pressure (if placed outside the room).

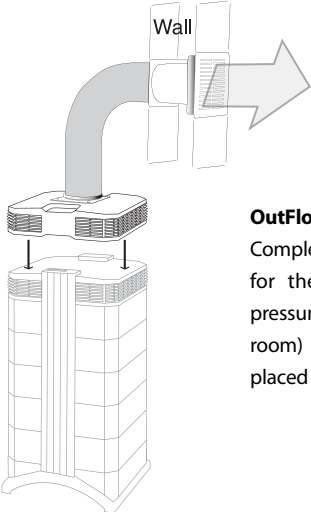

OutFlow™
Complete ducting adapter kit for the creation of negative pressure (if placed within the room) and positive pressure (if placed outside the room).

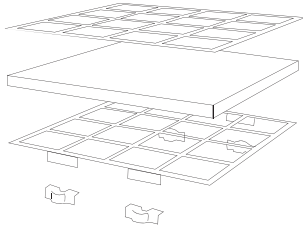

PF40™
Additional pre-filter for areas with high levels of coarse dust.

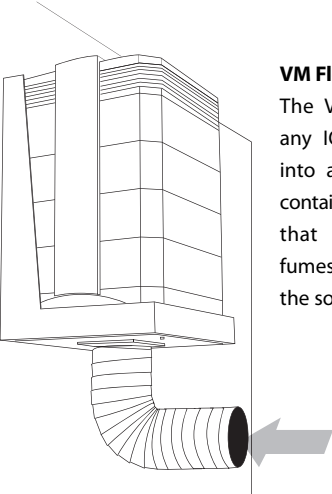

VM FlexVac™
The VM FlexVac converts any IQAir filtration device into a wall-mounted, self-contained extraction system that allows to capture fumes, dust and vapors at the source.

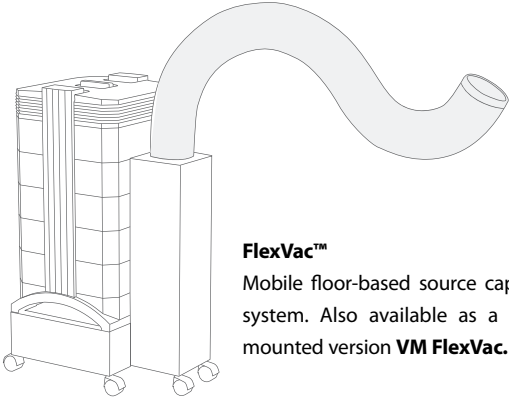

FlexVac™
Mobile floor-based source capture system. Also available as a wall-mounted version **VM FlexVac**.

Technical Specifications: IQAir® GC Series

NE

General Specifications	
Power requirements	100-120 V, 50/60 Hz
Energy consumption, 6 fan speeds*	27, 53, 92, 121, 154, 215 Watt; Standby: <1 Watt
Dimensions	H 28" x W 15" x D 16" (H 71 x W 38 x D 41 cm)
Weight, system incl. filters	MultiGas & AM: 44 lbs. (20 kg); VOC: 42 lbs. (19 kg); ChemiSorber: 48 lbs. (22 kg)
Air delivery, incl. filters, 6 fan speeds*	40, 75, 130, 170, 200, 300 cfm (70, 130, 220, 290, 340, 510 m ³ /h)
Sound pressure/power level, 6 fan speeds**	L _p 25, 36, 44, 50, 54, 59 dB(A); L _w 35, 46, 54, 60, 64, 69 dB(A)
Fan motor	centrifugal, backward curved, with thermal protector, non-stop use approved
Control panel	4-key touch-pad with 16 character 2-line LCD display
Air intake	dual arches at base of system
Air outlet	320° EvenFlow™ diffuser
Color of main housing / locking arms	light gray / blue
Housing material	non-offgasing, impact-resistant, UV-stabilized ABS
Operating temperature / humidity	41° to 104° F (5° to 40°C) / 5% to 95% non-condensing
Electrical safety certification	CSA rated for continuous operation under applicable UL and CSA standards, BSMI
Warranty	5 years (residential use), 1 year (commercial use) on parts and labor (excluding filters)
Performance	
Total system efficiency (certified)	≥ 99% for particles ≥ 0.3 microns (individually tested), ≥ 95% at ≥ 0.003 microns
Air delivery (certified)	yes (individually tested with all filters fitted)
Leak tested	yes
Filter Configuration	
Pre-filter	<p>GC HEPA Pre-Filter H11 (S)</p> <p>Purpose: control of coarse, fine & ultra-fine dust particles; protection of subsequent filters</p> <p>Media: non-woven glass microfiber HEPA filter, non-offgasing separators</p> <p>Efficiency: ≥99% at ≥ 0.3 microns (EN 1822 class H11)</p> <p>Surface area: 32 sq. ft. (3.0 m²)***</p> <p>Average filter life: approx. 12 months (based on average daily usage of 10h on speed 3)****</p>
Gas & odor filter	<p>GC Filter Cartridge Set</p> <p>Purpose: control of a wide range or specific chemical substances and odors</p> <p>Media options:</p> <ul style="list-style-type: none"> GC MultiGas™: 12 lbs. (5.4 kg) granular activated carbon & impregnated alumina (AC/4 + IA/4) GC VOC: 9 lbs. (4.2 kg) granular activated carbon (AC/4) GC ChemiSorber: 17 lbs. (7.8 kg) granular impregnated alumina (IA/4) GC AM: 12 lbs. (5.4 kg) granular impregnated activated carbon (AC/4-AM) <p>Average filter life: approx. 2 ½ years (based on average daily usage of 10h on speed 3)****</p>
Post-filter	<p>GC Post-Filter Sleeve Set</p> <p>Purpose: control of fine & ultra-fine particulate matter</p> <p>Media type: electrostatically charged fiber</p> <p>Surface area: 5.4 sq.ft. (0.5 m²)***</p> <p>Average filter life: approx. 2 ½ years (based on average daily usage of 10h on speed 3)****</p>
Features	
Display languages	4 user-selectable languages: English, French, German, Spanish
Intelligent filter life monitor	yes (monitors actual usage of each individual filter), 3 filter life status LEDs
Advanced timer	yes (allows programming of operating hours and weekdays)
Advanced fan speed selection	yes (allows programming of different fan speeds for 2 different time periods)
Supplied accessories	remote control (incl. battery), power cord with plug, deluxe casters, certificate of performance
Optional accessories	FlexVac & VM FlexVac mobile & wall-mounted source capture kits, InFlow & OutFlow positive/negative pressure duct kits, PF40 coarse dust pre-filter, VMF wall-mount bracket.

* per fan speed measured at 120V, 60Hz; tolerance: ± 10% (± 6 cfm); ** tolerance: ± 3 dB(A); *** tolerance: ± 10% **** filter life can vary based on actual usage and pollution levels

All technical specifications are subject to change without prior notice.

