

Duluth Forge

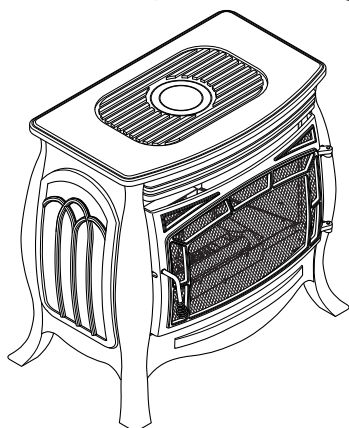

**VENT-FREE GAS STOVE
OWNER'S OPERATION AND
INSTALLATION MANUAL
MODELS
FDSR25 & FDSR25GF**



⚠ WARNING: If the information in this manual is not followed exactly, a fire or explosion may result causing property damage, personal injury or loss of life.

- Do not store or use gasoline or other flammable vapors and liquids in the vicinity of this or any other appliance.
- **WHAT TO DO IF YOU SMELL GAS**
 - Do not try to light any appliance.
 - Do not touch any electrical switch; do not use any phone in your building.
 - Immediately call your gas supplier from a neighbor's phone. Follow the gas supplier's instructions.
 - If you cannot reach your gas supplier, call the fire department.
- Installation and service must be performed by a qualified installer, service agency or the gas supplier.

⚠ WARNING: This appliance is equipped for natural and propane gas. Field conversion is not permitted other than between natural or propane gases.



Questions, problems, missing parts? Before returning to your retailer, call our customer service department at 1-855-607-6557, 8:00 am - 4:30 pm EST, Monday through Friday or email info@factorybuysdirect.com

TABLE OF CONTENTS

Safety	3	Operation.....	18
Specifications	4	Inspecting Burners.....	22
Qualified Installing Agency	5	Care And Maintenance.....	23
Product Features	5	Electrical.....	24
Local Codes.....	5	Troubleshooting.....	26
Product Identification.....	6	Service Hints	29
Unpacking.....	6	Technical Service.....	29
Water Vapor: A By-Product Of		Accessories	29
Unvented Room Heaters.....	6	Parts	30
Air For Combustion and Ventilation.....	7	Replacement Parts.....	31
Installation	8	Warranty	32

SAVE THIS BOOK

INSTALLER: Leave this manual with the appliance.
CONSUMER: Retain this manual for future reference.

This is an unvented gas-fired stove. It uses air (oxygen) from the room in which it is installed. Provisions for adequate combustion and ventilation air must be provided. Refer to *Air For Combustion and Ventilation* section on page 7 of this manual.

⚠ WARNING: Improper installation, adjustment, alteration, service or maintenance can cause injury or property damage. Refer to this manual for correct installation and operational procedures. For assistance or additional information consult a qualified installer, service agency or the gas supplier.

This appliance may be installed in an aftermarket,* permanently located, manufactured (mobile) home, where not prohibited by local codes.

This appliance is only for use with propane or natural gas. Field conversion by any other means including the use of a kit is not permitted.

* Aftermarket: Completion of sale, not for purpose of resale, from the manufacturer.

PATENT INFORMATION

This product may be covered by one or more of the following United States patents:
8,915,239 8,851,065 8,764,436 8,757,202 8,757,139 8,752,541 8,568,136
8,545,216 8,517,718 8,516,878 8,506,290 8,465,277 8,317,511 8,297,968
8,281,781 8,241,034 8,235,708 8,152,515 8,011,920 7,967,006 7,967,007
7,654,820 7,730,765 7,677,236 7,607,426 7,434,447

SAFETY

IMPORTANT: Read this owner's manual carefully and completely before trying to assemble, operate, or service this stove. Improper use of this stove can cause serious injury or death from burns, fire, explosion, electrical shock and carbon monoxide poisoning. Failure to follow these instructions will void the warranty.

Only a qualified installer, service agent, or local gas supplier may install and service this product.

⚠ WARNING: Keep the appliance area clear and free from combustible materials, gasoline, and other flammable vapors and liquids.

⚠ WARNING: This appliance can be used with propane or natural gas. It is shipped from the factory adjusted for use with propane.

⚠ DANGER: Carbon monoxide poisoning may lead to death!

CARBON MONOXIDE POISONING: Early signs of carbon monoxide poisoning resemble the flu, with headaches, dizziness or nausea. If you have these signs, the stove may not be working properly. Get fresh air at once! Have stove serviced. Some people are more affected by carbon monoxide than others. These include pregnant women, people with heart or lung disease or anemia, those under the influence of alcohol and those at high altitudes.

NATURAL AND PROPANE/LP GAS: Natural and Propane/LP gas are odorless. An odor-making agent is added to the gas. The odor helps you detect a gas leak. However, the odor added to the gas can fade. Gas may be present even though no odor exists.

⚠ WARNING: Any change to this stove or its controls can be dangerous.

⚠ WARNING: Do not allow fans to blow directly into stove. Avoid any drafts that alter burner flame patterns.

⚠ WARNING: Do not use a blower insert, heat exchanger insert or other accessory not approved for use with this stove.

⚠ WARNING: Due to high temperatures, the appliance should be located out of traffic and away from furniture and draperies.

⚠ WARNING: Do not place clothing or other flammable material on or near the appliance. Never place any objects in the stove.

⚠ WARNING: The stove becomes very hot when operating. Keep children and adults away from hot surfaces to avoid burns or clothing ignition. Stove will remain hot for a time after shutdown. Allow surfaces to cool before touching.

⚠ WARNING: Carefully supervise young children when they are in the room with the stove.

⚠ WARNING: You must operate this stove with the door and screen in place.

SAFETY

1. Do not place Propane/LP supply tank(s) inside any structure. Propane/LP supply tank(s) must be placed outdoors.
2. This stove shall not be installed in a bedroom or bathroom.
3. This stove needs fresh air ventilation to run properly. This stove has an Oxygen Depletion Sensing (ODS) safety shutoff system. The ODS shuts down the stove if not enough fresh air is available. See *Air for Combustion and Ventilation*, pages 7. If stove keeps shutting off, see *Troubleshooting*, page 26.
4. Keep all air openings in front and bottom of stove clear and free of debris. This will ensure enough air for proper combustion.
5. If stove shuts off, do not relight until you have provided fresh, outside air. If stove keeps shutting off, have it serviced.
6. Do not run stove:
 - Where flammable liquids or vapors are used or stored.
 - Under dusty conditions.
7. Before using furniture polish, wax, carpet cleaner, or similar products, turn stove off. If heated, the vapors from these products may create a white powder residue within burner box or on adjacent walls or furniture.
8. Do not use stove if any part has been under water. Immediately call a qualified service technician to inspect the room stove and to replace any part of the control system and any gas control which has been under water.
9. Turn stove off and let cool before servicing. Only a qualified service person should service and repair stove.
10. Operating stove above elevations of 4,500 feet could cause pilot outage.
11. To prevent performance problems, do not use propane/LP fuel tank of less than 100 lbs. capacity.
12. Do not use this stove as a wood-burning stove. Use only the logs provided with the stove.
13. Solid fuels should not be burned in a stove in which a vent-free log set is installed. Do not use this stove to cook food or burn paper or other objects.
14. To prevent sooting, follow the instructions in *Care and Maintenance* (see page 23).
15. Do not add extra logs or ornaments such as pine cones, vermiculite, or rock wool. Using these added items can cause sooting. Do not add lava rock around base. Rock and debris could fall into the control area of stove. After servicing, always close door before operating stove.
16. This stove is designed to be smokeless. If logs ever appear to smoke, turn off stove and call a qualified service person.

Note: During initial operation, slight smoking could occur due to log curing and the stove burning manufacturing residues.
17. Do not use this stove if any log is broken. Do not operate stove if a log has a chip (dime-sized or larger).

SPECIFICATIONS

Gas Type	Natural Gas	Propane Gas
Input Rating	26,000 Btu/Hr	26,000 Btu/Hr
Ignition	Electronic Piezo	Electronic Piezo
Regulator Pressure Setting	4" W.C.	9" W.C.
Inlet Gas Pressure* (inches of water) (*for purposes of input adjustment)	Maximum 9"	Maximum 14"
	Minimum 5"	Minimum 11"
Stove Dimensions (HxWxD) • 26.125" × 28" × 16.875"		
Carton Dimensions (HxWxD) • 31.125" × 31.375" × 20.5"		
Stove Weight • 73 lbs		Shipping Weight • 85 lbs
120 Volts • 19 Watts		

QUALIFIED INSTALLING AGENCY

Only a qualified agency should install and replace gas piping, gas utilization equipment or accessories, and repair and equipment servicing. The term "qualified agency" means any individual, firm, corporation, or company that either in person or through a representative is engaged in and is responsible for:

- a) Installing, testing, or replacing gas piping or
- b) Connecting, installing, testing, repairing, or servicing equipment; that is experienced in such work; that is familiar with all precautions required; and that has complied with all the requirement of the authority having jurisdiction.

PRODUCT FEATURES

SAFETY PILOT

This stove has a pilot with an Oxygen Depletion Sensing (ODS) safety shutoff system. The ODS/pilot shuts off the stove if there is not enough fresh air.

PIEZO IGNITION SYSTEM

This stove is equipped with an electronic piezo control system. This system requires one AAA battery (provided).

THERMOSTATIC CONTROL

The control automatically cycles the burner on and off to maintain a desired room temperature.

2 GAS OPTIONS AVAILABLE

Your stove is equipped to operate on either Propane/LP or Natural gas. The stove is shipped from the factory ready for connecting to Propane/LP. The stove can easily be changed to Natural gas by having your qualified installer follow the instructions on page 10 and the markings on the stove.

MANUAL OVERRIDE CONTROL SYSTEM

This stove has two operation functions. Remote Control and Manual Override Control. The remote control has a transmitter, which requires two AAA batteries and electric power outlet to operate. In the event of a power outage, you can operate the the stove by manual override.

LOCAL CODES

Install and use stove with care. Follow all local codes. In the absence of local codes, use the latest edition of *The National Fuel Gas Code, ANSI Z223.1/NFPA 54**.

*Available from:

American National Standards Institute, Inc.
1430 Broadway
New York, NY 10018

National Fire Protection Association, Inc.
1 Batterymarch Park
Quincy, MA 02269-9101

This stove is designed for vent-free operation. State and local codes in some areas prohibit the use of vent-free stoves.

State of Massachusetts: The installation must be made by a licensed plumber or gas fitter in the Commonwealth of Massachusetts.

Sellers of unvented propane or natural gas-fired supplemental room heaters shall provide to each purchaser a copy of 527 CMR 30 upon sale of the unit.

In the State of Massachusetts the gas cock must be a T-handle type. The State of Massachusetts requires that a flexible appliance connector cannot exceed three feet in length.

PRODUCT IDENTIFICATION



Figure 1 - Vent-Free Stove

UNPACKING

1. Remove top inner pack.
2. Tilt carton so that stove is upright.
3. Remove protective side packaging.
4. Slide stove out of carton.
5. Remove protective plastic wrap.
6. Rotate door handle and open door.
7. Carefully remove logs.
8. Carefully unwrap logs.
9. Check for any shipping damage. If stove or log is damaged, contact our customer service department.

WATER VAPOR: A BY-PRODUCT OF UNVENTED ROOM HEATERS

Water vapor is a by-product of gas combustion. An unvented room heater produces approximately one (1) ounce (30 mL) of water for every 1,000 BTUs (0.3 KWs) of gas input per hour. Unvented room heaters are recommended as supplemental heat (a room) rather than a primary heat source (an entire house). In most supplemental heat applications, the water vapor does not create a problem. In most applications, the water vapor enhances the low humidity atmosphere experienced during cold weather.

The following steps will help ensure that water vapor does not become a problem.

1. Be sure the heater is sized properly for the application, including ample combustion air and circulation air.
2. If high humidity is experienced, a dehumidifier may be used to help lower the water vapor content of the air.
3. Do not use an unvented room heater as the primary heat source.

AIR FOR COMBUSTION AND VENTILATION

⚠ WARNING: This heater shall not be installed in a confined space or unusually tight construction unless provisions are provided for adequate combustion and ventilation air. Read the following instructions to insure proper fresh air for this and other fuel-burning appliances in your home.

Today's homes are built more energy efficient than ever. New materials, increased insulation and new construction methods help reduce heat loss in homes. Home owners weather strip and caulk around windows and doors to keep the cold air out and the warm air in. During heating months, home owners want their homes as airtight as possible.

While it is good to make your home energy efficient, your home needs to breathe. Fresh air must enter your home. All fuel-burning appliances need fresh air for proper combustion and ventilation.

Exhaust fans, fireplaces, clothes dryers and fuel burning appliances draw air from the house to operate. You must provide adequate fresh air for these appliances. This will insure proper venting of vented fuel-burning appliances.

⚠ WARNING: This heater shall not be installed in a room or space unless the required volume of indoor combustion air is provided by the method described in the *National Fuel Gas Code, ANSI Z223.1/NFPA 54*, the *International Fuel Gas Code*, or applicable local codes.

⚠ WARNING: If the area in which the heater may be operated does not meet the required volume for indoor combustion air, combustion and ventilation air shall be provided by one of the methods described in the *National Fuel Gas Code, ANSI Z223.1/NFPA 54*, the *International Fuel Gas Code*, or applicable local codes.

VENTILATION AIR

Ventilation Air From Inside Building

This fresh air would come from an adjoining unconfined space. When ventilating to an adjoining unconfined space, you must provide two permanent openings: one within 12" of the ceiling and one within 12" of the floor on the wall connecting the two spaces (see options 1 and 2, Figure 2). You can also remove door into adjoining room (see option 3, Figure 4). Follow the *National Fuel Gas Code, ANSI Z223.1/NFPA 54, Air for Combustion and Ventilation* for required size of ventilation grills or ducts.

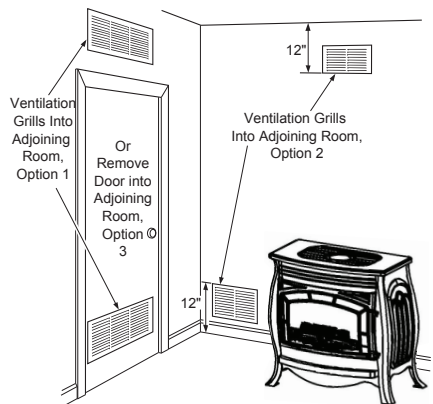

Figure 4 - Ventilation Air from Inside Building

AIR FOR COMBUSTION AND VENTILATION

Ventilation Air From Outdoors

Provide extra fresh air by using ventilation grills or ducts. You must provide two permanent openings: one within 12" of the ceiling and one within 12" of the floor. Connect these items directly to the outdoors or spaces open to the outdoors. These spaces include attics and crawl spaces. Follow the *National Fuel Gas Code, ANSI Z223.1/NFPA 54, Air for Combustion and Ventilation* for required size of ventilation grills or ducts.

IMPORTANT: Do not provide openings for inlet or outlet air into attic if attic has a thermostat-controlled power vent. Heated air entering the attic will activate the power vent. Rework worksheet, adding the space of the adjoining unconfined space. The combined spaces must have enough fresh air to supply all appliances in both spaces.

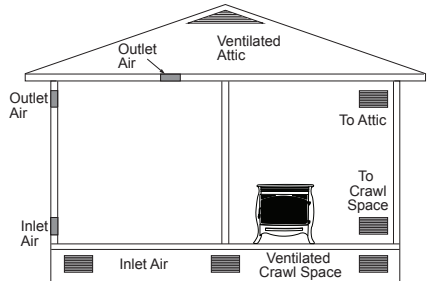

Figure 5 - Ventilation Air from Outdoors

INSTALLATION

NOTICE: This stove is intended for use as supplemental heat. Use this stove along with your primary heating system. Do not install this stove as your primary heat source. If you have a central heating system, you may run system's circulating blower while using stove. This will help circulate the heat throughout the house. In the event of a power outage, you can use this stove as your primary heat source.

WARNING: A qualified service person must install stove. Follow all local codes.

WARNING: Electrical Grounding Instructions If using a blower, this appliance is equipped with a three-prong (grounding) plug for your protection against shock hazard and should be plugged directly into a properly grounded three-prong receptacle.

WARNING: Never install the stove

- in a bedroom or bathroom
- in a recreational vehicle
- where curtains, furniture, clothing, or other flammable objects are less than 48" from the front, top, or sides of the stove.
- in high traffic areas
- in windy or drafty areas

CAUTION: This stove creates warm air currents. These currents move heat to wall surfaces next to stove. Installing stove next to vinyl or cloth wall coverings or operating stove where impurities (such as tobacco smoke, aromatic candles, cleaning fluids, oil or kerosene lamps, etc.) in the air exist, may cause walls to discolor.

IMPORTANT: Vent-free heaters add moisture to the air. Although this is beneficial, installing heater in rooms without enough ventilation air may cause mildew to form too much moisture. See *Air for Combustion and Ventilation*, pages 7.

INSTALLATION

CONNECTING ELECTRICAL SUPPLY

This stove requires a 120V electrical outlet within 4 feet of the unit. This is a power supply for the remote receiver located in the bottom of the stove. Extensions cords may be used.

The remote receiver requires 4 AA batteries. This powers the stove in case of an electrical power outage.

1. Locate 6V DC adapter.
2. Plug connector end of adapter into the power change assembly on the back of the stove.
3. Plug adapter into a 120V electrical outlet.

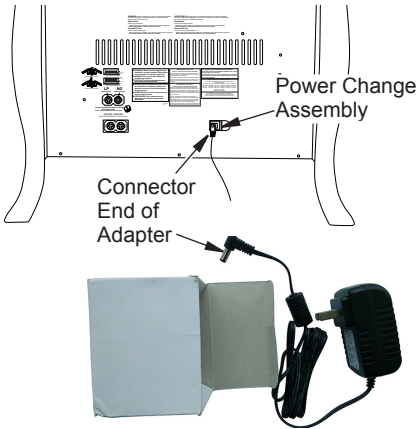

Figure 6 - Connecting to Power Supply

Blower Accessory

If using a blower accessory, install at this time. See instructions included with blower.

CHECK GAS TYPE

Be sure your gas supply is right for your stove. Otherwise, call dealer where you bought the stove for proper type stove.

CLEARANCES TO COMBUSTIBLES

⚠ WARNING: You must maintain the minimum clearances. If you can, provide greater clearances from floor, ceiling, and adjoining wall. Measure from outermost point of stove.

This stove is designed to sit directly on the floor or on a mantel base.

IMPORTANT: You must maintain minimum wall and ceiling clearances during installation. The minimum clearances are shown in Figure 7. Measure from outermost point of stove.

Minimum Wall and Ceiling Clearances

- A. Clearances from outermost point of stove to any combustible side wall should not be less than 12".
- B. Clearances from the stove to the ceiling should not be less than 48".
- C. Clearance from stove to back wall should not be less than 6".

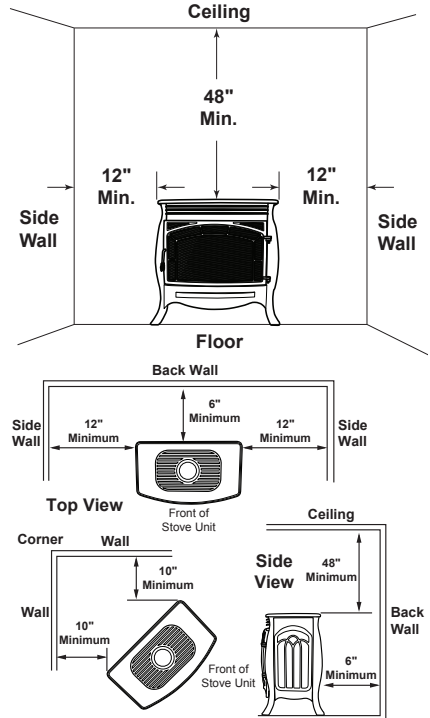

Figure 7 - Minimum Clearance to Wall and Ceiling

INSTALLATION

GAS SELECTION

This appliance is factory preset for propane/LP gas. No changes are required for connecting to propane/LP. Only a qualified installer or service technician can perform gas selection and connecting to gas supply.

⚠ CAUTION: Two gas line installations at the same time are prohibited.

⚠ CAUTION: To avoid gas leakage for the gas not being used at the inlet of regulator, a qualified installer or service technician must use supplied cap.

You will notice a color coded plunger on the inside of the regulator. This is normal. When the inlet connection fitting is inserted and tightened, this plunger will be pushed back by the fitting making all of the adjustments for the gas being supplied. **DO NOT REMOVE THE PLUNGER.** The regulator will not work.

The inlet regulator is color coded for identification of the correct gas type. Blue is for propane (LP gas) and yellow is for natural gas.

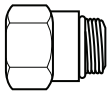

Fitting supplied with the product located in the hardware bag. Fitting part number:
160960-02 (straight)
160960-03 (elbow)

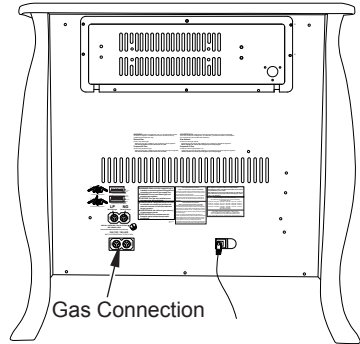

Figure 8 - Back of Stove

Yellow Natural Gas Plunger Underneath Metal Cap Blue Propane/LP Gas Plunger Underneath Dust Cover

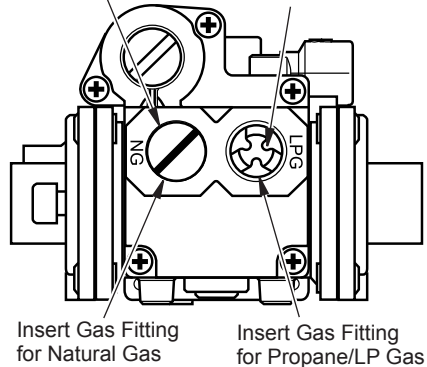
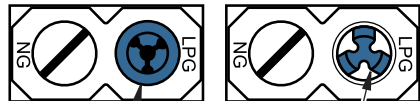

Figure 9 - Gas Regulator

FOR PROPANE/LP GAS INSTALLATION: BLUE

1. Remove blue dust cover.



Blue Dust Cover

DO NOT REMOVE
Blue Propane/LP Plunger
Install Gas Fitting Here

INSTALLATION

- Apply thread sealant to the threads on the connection fitting. While pushing in, rotate the fitting clockwise until the threads engage the regulator. After the fitting has been hand tightened into the regulator use a wrench to complete tightening of the fitting. Install additional fitting to connect to the house supply.



Use only the cap supplied on the regulator. Do not use an off the shelf pipe plug. This can damage the plunger. The supplied regulator cap is designed so it will not engage the unused gas type.

- Apply thread sealant to the threads on the connection fitting. While pushing in, rotate the fitting clockwise until the threads engage the regulator. After the fitting has been hand tightened into the regulator use a wrench to complete tightening of the fitting. Install additional fitting to connect to the house supply.



FOR NATURAL GAS (NG) INSTALLATION: YELLOW

- Remove the blue dust cover from the regulator.

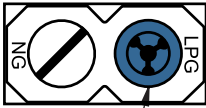

Blue Dust Cover

- Remove the metal cap installed over the NG regulator inlet.



Metal Cap

- Install metal cap over LP/Propane regulator inlet. This will keep debris out of regulator.



DO NOT REMOVE
Yellow Natural Gas Plunger
Install Gas Fitting Here

Metal Cap

DO NOT use an off the shelf 3/8" NPT pipe plug. This will damage the plungers located inside the regulator.

DO NOT try to remove the plungers from inside the regulator. The plunger will be pushed back as the fitting is installed.

Make sure the type of gas being used is correct. Check to make sure the connection fitting is in the correct inlet on the regulator. Refer to Connecting to Gas Supply, page 12.

If you are using natural gas and the pilot will not light, see Troubleshooting, page 26.

INSTALLATION

CONNECTING TO GAS SUPPLY

⚠ WARNING: A qualified service technician must connect stove to gas supply. Follow all local codes.

⚠ WARNING: This appliance requires a 3/8" NPT (National Pipe Thread) inlet connection to the pressure regulator.

⚠ WARNING: For natural gas, Never connect stove to private (non-utility) gas wells. This gas is commonly known as wellhead gas.

⚠ CAUTION: For propane/LP gas, never connect stove directly to the gas supply. This stove requires an external regulator (not supplied). Install the external regulator between the stove and propane/LP gas supply. Gas supplier provides external regulator for natural gas. The installer provides the external regulator for propane/LP gas.

⚠ WARNING: Do not over-tighten gas connections.

⚠ CAUTION: Use only new, black iron or steel pipe. Internally tinned copper tubing may be used in certain areas. Check your local codes. Use pipe of 1/2" diameter or greater to allow proper gas volume to stove. If pipe is too small, undue loss of pressure will occur.

⚠ CAUTION: For natural gas, check your gas line pressure before connecting stove to gas line. Gas line pressure must be no greater than 9" of w.c. If gas line pressure is higher, stove regulator damage could occur.

⚠ CAUTION: Avoid damage to regulator. Hold gas regulator with wrench when connecting into gas piping and/or fittings.

⚠ CAUTION: Use pipe joint sealant that is resistant to gas (Propane/LP or Natural Gas).

Before installing stove, make sure you have the items listed below:

- external regulator for propane/LP unit only (supplied by installer)
- piping (check local codes)
- sealant (resistant to natural gas and propane/LP gas)
- equipment shutoff valve*
- test gauge connection*
- sediment trap
- tee joint
- pipe wrench
- flexible gas hose (check local codes)

* A CSA design-certified equipment shutoff valve with 1/8" NPT tap is an acceptable alternative to test gauge connection. Purchase the optional CSA design certified equipment shutoff valve from your dealer (see [Accessories](#), page 29).

Typical Inlet Pipe Diameters

Use 1/2" black iron pipe or greater. Installation must include an equipment shutoff valve, union, and plugged 1/8" NPT tap. Locate NPT tap within reach for test gauge hook up. NPT tap must be upstream from stove (see Figure 11, page 13).

IMPORTANT: Install an equipment shutoff valve in an accessible location. The equipment shutoff valve is for turning on or shutting off the gas to the appliance.

INSTALLATION

For propane/LP installations, apply pipe joint sealant lightly to male threads. This will prevent excess sealant from going into pipe. Excess sealant in pipe could result in clogged stove valves.

The installer must supply an external regulator. The external regulator will reduce incoming gas pressure. You must reduce incoming gas pressure to between 11" and 14" of w.c. If you do not reduce incoming gas pressure, stove regulator damage could occur. Install external regulator with the vent pointing down as shown in Figure 12. Pointing the vent down protects it from freezing rain or sleet.

Install sediment trap in supply line as shown in Figure 11. Place sediment trap where it is within reach for cleaning. Place sediment trap where trapped matter is not likely to freeze. A sediment trap traps moisture and contaminants. This keeps them from going into stove controls. If sediment trap is not installed or is installed wrong, stove may not run properly.

⚠ WARNING: Test all gas piping and connections for leaks after installing or servicing. Correct all leaks at once (see page 14).

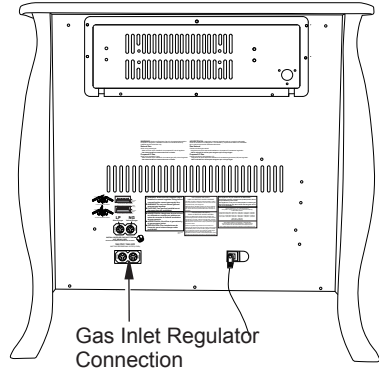

Figure 10 - Gas Regulator Location and Gas Line Access Into Stove Cabinet

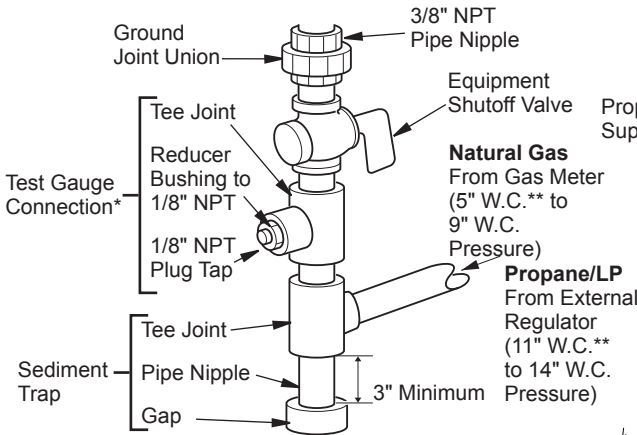

Figure 11 - Gas Connection

* Purchase the optional CSA design-certified equipment shutoff valve from your dealer (see [Accessories](#), page 29).

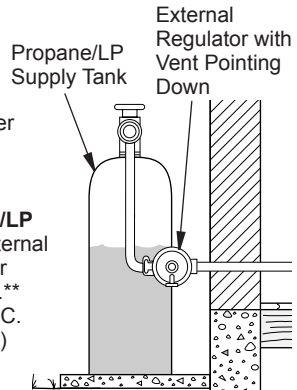

Figure 12 - External Regulator with Vent Pointing Down

INSTALLATION

CHECKING GAS CONNECTIONS

⚠ WARNING: Test all gas piping and connections for leaks after installing or servicing. Correct all leaks at once.

⚠ WARNING: Never use an open flame to check for a leak. Apply a noncorrosive leak detection fluid to all joints. If bubbles form, there is a leak. Correct all leaks at once.

PRESSURE TESTING GAS SUPPLY PIPING SYSTEM

Test Pressures In Excess Of 1/2 PSIG (3.5 kPa)

1. Disconnect stove with its appliance main gas valve (control valve) and equipment shutoff valve from gas supply piping system. Pressures in excess of 1/2 PSIG will damage stove regulator.
2. Cap off open end of gas pipe where equipment shutoff valve was connected.
3. Pressurize supply piping system by either opening propane/LP supply tank valve for propane/LP gas or opening main gas valve located on or near gas meter for natural gas or using compressed air.
4. Check all joints of gas supply piping system. Apply noncorrosive leak detection fluid to all joints. If bubbles form, there may be a leak.
5. Correct all leaks at once.
6. Reconnect stove and equipment shutoff valve to gas supply. Check reconnected fittings for leaks.

Test Pressures Equal To or Less Than 1/2 PSIG (3.5 kPa)

1. Close equipment shutoff valve (see Figure 13).
2. Pressurize supply piping system by either opening propane/LP supply tank valve for propane/LP gas or opening main gas valve located on or near gas meter for natural gas or using compressed air.
3. Check all joints from gas meter to equipment shutoff valve for natural gas or propane/LP supply to equipment shutoff

valve for propane/LP (see Figure 14 or 15). Apply a noncorrosive leak detection fluid to all joints. Bubbles forming show a leak.

4. Correct all leaks at once.

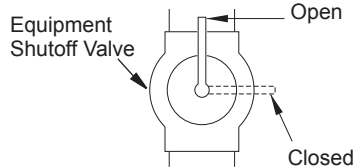

Figure 13 - Equipment Shutoff Valve

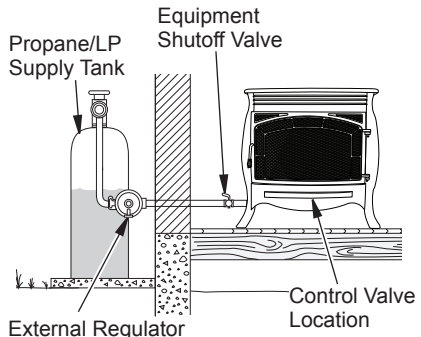

Figure 14 - Checking Gas Joints for Propane/LP Gas

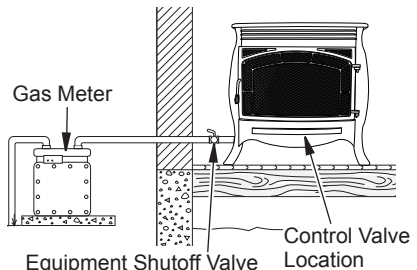

Figure 15 - Checking Gas Joints for Natural Gas

PRESSURE TESTING HEATER GAS CONNECTIONS

1. Open equipment shutoff valve (see Figure 13).
2. Open main gas valve located on or near gas meter for natural gas or open propane/LP supply tank valve.
3. Make sure control knob of stove is in the OFF position.

INSTALLATION

4. Check all joints from equipment shutoff valve to control valve (see Figure 14 or 15, page 14). Apply a noncorrosive leak detection fluid to all joints. Bubbles forming show a leak.
5. Correct all leaks at once.
6. Light stove (see Lighting Instructions on page 18). Check all other internal joints for leaks.
7. Turn off stove (see To Turn Off Gas Appliance, page 19).

INSTALLING BATTERIES

⚠ CAUTION: Do not mix old and new batteries. Do not mix alkaline, standard (carbon - zinc), or rechargeable (nickel - cadmium) batteries. Do not dispose of batteries in fire, batteries may explode or leak.

- Batteries are included.
- Remove batteries when depleted.
- Install/replace the batteries according to the type and quantity stated in table below.
- Do not mix old and new batteries. New batteries should be the same brand for best results.
- Be sure to observe proper polarity (+/-) when installing or replacing the batteries. Damage due to improper battery installation may void the warranty on the product.
- For remote control systems, maximize battery life by turning off the receiver when it is not in use.
- For long periods of non-operation, remove batteries from all components for safety.

Component	Type of Battery	Qty.
Ignitor	AAA	1
Remote Control	AAA	2 or 3*
Remote Receiver	AA	4

*Note: Quantity depends on model of remote control.

Ignitor

Unscrew ignitor cap and install a AAA battery with the + pointing out. Replace cap.

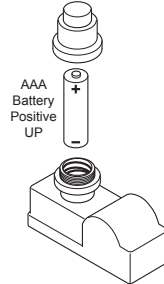

Figure 16 - Installing Battery in Ignitor

Receiver and Remote Control

Batteries are required in both the Remote Control (Transmitter) (2 AAA size) and Receiver (4 AA size) (see Figure 17).

Note: Be sure batteries are placed correctly. Reversing the batteries can cause damage to the receiver and remote. Replace all batteries on a yearly basis or sooner.

Position the slide switch on the front of the receiver box in the ON position before installing batteries. Once the batteries are installed you will hear a single beep which indicates the batteries are charged. If you do not hear a beep, replace with new batteries.

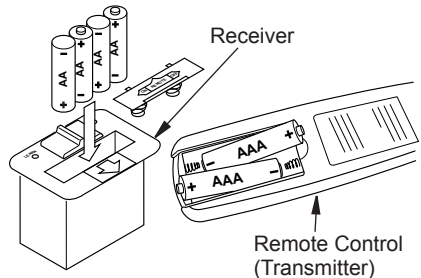

Figure 17 - Installing Batteries in Remote Control and Receiver

INSTALLATION

INSTALLING LOGS

⚠ WARNING: Failure to position the parts in accordance with these diagrams or failure to use only parts specifically approved with this stove may result in property damage or personal injury.

⚠ CAUTION: After installation, and periodically thereafter, check to ensure that no flame comes in contact with any log. With the stove set to high, check to see if flames contact any log. If so, reposition logs according to the log installation instructions in this manual. Flames contacting logs will create soot.

It is very important to install the logs exactly as instructed. Do not modify logs. Use only logs supplied with stove. Each log is marked with a number. This number will help you to identify the logs when installing. Do not place any decorative cinders on logs or burner.

1. Remove the packing material from the logs. The log number is marked on the back of each log.
Refer to Figure 18 for log placement.
2. Place pins on log #1 into two slots in the rear bracket.
3. Place pins on log #2 into slots in the middle bracket.
4. Place pins on log #3 into slots the front bracket.

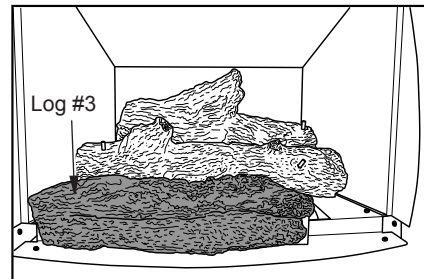
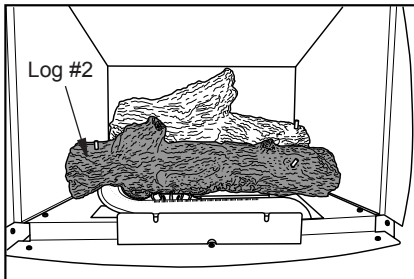
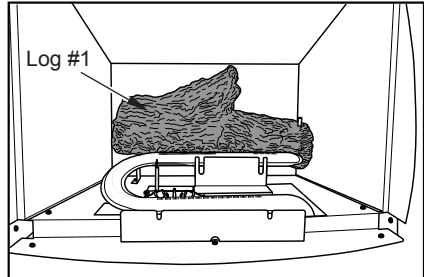
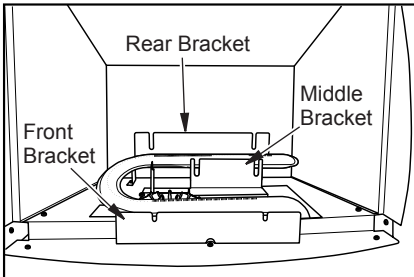

Figure 18a - Log Installation

INSTALLATION

5. Install hole in log #4 onto pin on the left side of log #2, with one end resting on log #3.
6. Install hole in log #5 onto pin on the right side of log #1, with one end resting on log #2.
7. Install hole in log #6 onto the pin on the right side of log #3.

IMPORTANT: Make sure logs do not cover any burner ports. It is very important to install the logs exactly as instructed. Do not modify logs. Use only logs supplied with stove.

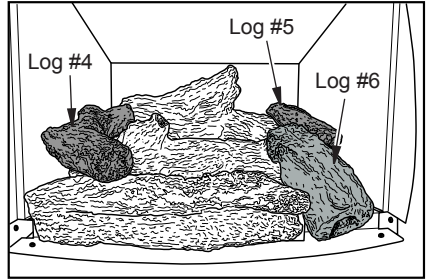

Figure 18b - Log Installation

OPERATION

FOR YOUR SAFETY READ BEFORE LIGHTING

⚠ WARNING: If you do not follow these instructions exactly, a fire or explosion may result causing property damage, personal injury or loss of life.

- A. This appliance has a pilot which must be lighted by hand. When lighting the pilot, follow these instructions exactly.
- B. **BEFORE LIGHTING** smell all around the appliance area for gas. Be sure to smell next to the floor because some gas is heavier than air and will settle on the floor.
WHAT TO DO IF YOU SMELL GAS
 - Do not try to light any appliance.
 - Do not touch any electric switch; do

- not use any phone in your building.
- Immediately call your gas supplier from a neighbor's phone. Follow the gas supplier's instructions.
- If you cannot reach your gas supplier, call the fire department.

- C. Use only your hand to push in or turn the gas control knob. Never use tools. If the knob will not push in or turn by hand, don't try to repair it, call a qualified service technician. Force or attempted repair may result in a fire or explosion.
- D. Do not use this appliance if any part has been under water. Immediately call a qualified service technician to inspect the appliance and to replace any part of the control system and any gas control which has been under water.

LIGHTING INSTRUCTIONS

⚠ WARNING: You must operate this stove with the door in place. Make sure door and screen are installed before running stove.

NOTICE: During initial operation of new stove, burning logs will give off a paper-burning smell. Orange flame will also be present. Open damper or window to vent smell. This will only last a few hours.

1. STOP! Read the safety information above.
2. Turn handle and open stove door.
3. Make sure equipment shutoff valve is fully open.
4. Push in control knob slightly and turn clockwise ↻ to the OFF position (see Figure 19).
5. Wait five (5) minutes to clear out any gas. Then smell for gas around stove and near the floor. If you smell gas, STOP! Follow "B" in the safety information above. If you do not smell gas, go to the next step.
6. Push in control knob slightly and turn counterclockwise ↻ to the PILOT position. Press in control knob for five (5) seconds.

Note: The first time that the stove is operated after connecting the gas supply, the control knob should be pressed for about thirty (30) seconds. This will allow air to bleed from the gas system. If pilot does not stay lit, refer to Troubleshooting, pages 26 through 29. Also contact a qualified service technician or gas supplier for repairs. Until repairs are made, light pilot with match.

- If control knob does not pop up when released, contact a qualified service technician or gas supplier for repairs.
7. With control knob pressed in, press in and release ignitor button. This will light pilot. The pilot is attached to the rear of the burner. If needed, keep pressing ignitor button until pilot lights.

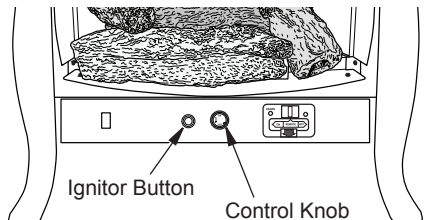

Figure 19 - Ignitor Button and Control Knob Locations

OPERATION

Note: If pilot does not stay lit, refer to [Troubleshooting](#), pages 26 through 29. Also contact a qualified service technician or gas supplier for repairs. Until repairs are made, light pilot with match. To light pilot with match, see [Manual Lighting Procedure](#).

- Keep control knob pressed in for 30 seconds after lighting pilot. After 30 seconds, release control knob.

Note: If pilot goes out, repeat steps 4 through 8. This stove has a safety interlock system. Wait one (1) minute before lighting pilot again.

- Be sure the slide switch on the front of the receiver box is in the ON position.
- Turn control knob counterclockwise ↶ to the ON position. The main burner should light.

Note: If burner does not light, push the slide switch on the receiver box to the OFF position, then back to the ON position.

Note: Please wait one minute after shutting off stove to allow the control valve to reset before starting again.

- If stove will not operate, follow the instructions [To Turn Off Gas To Appliance](#), and call your service technical or gas supplier.

⚠ CAUTION: Do not try to adjust heating levels by using the equipment shutoff valve.

⚠ WARNING: If input gas type is NG, make sure NG pilot burner ignites. If input gas type is LP, make sure LP pilot burner ignites.

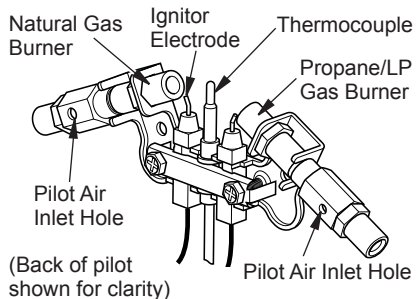

Figure 20 - Pilot

TO TURN OFF GAS TO APPLIANCE

Shutting Off Heater

Turn control knob clockwise ↷ to the OFF position.

Shutting Off Burner Only (pilot stays lit)

Turn control knob clockwise ↷ to the PILOT position.

MANUAL LIGHTING PROCEDURE

- Turn handle and open stove door.
- Follow steps 1 through 5 under [Lighting Instructions](#), page 18.
- With control knob in PILOT position, strike match, and hold near pilot. Press in control knob; pilot should light.
- Keep control knob pressed in for 30 seconds after lighting pilot. After 30 seconds, release control knob.
- Make sure the stove door is closed before operating stove.

OPERATION

REMOTE CONTROL SYSTEM

Programming the Remote and Receiver

The remote and receiver must be "learned" to one another.

To prepare the receiver box for learning, use a pen or small screwdriver to gently press and hold the learn button until you hear 3 series of beeps.

1. Place the slide switch on the receiver in the remote position (see Figure 22).
2. Turn control knob on the stove to the ON position.
3. Use a pen or small screwdriver to gently press and hold the recessed LEARN button on the face of the receiver for 2-3 seconds. You will hear a beep.
4. Press the ON button on the remote control to light the burner (see Figure 22). You will hear a series of beeps. This will also "learn", or program, the remote and the receiver.

Note: Remote must be at least 5 feet away from the receiver during the learning process.

Note: If the remote control is lost or damaged, the slide switch on the receiver can be used to operate the stove.

Note: When batteries are replaced the learning process above must be repeated.

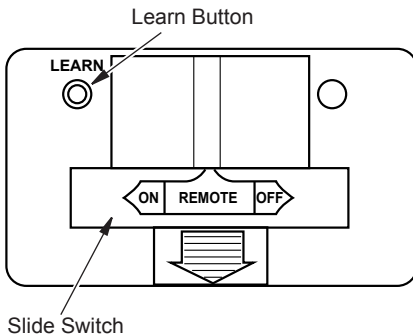

Figure 21 - Receiver

Remote Control Operation

This appliance must not be used with glass doors in the closed position. This can lead to pilot outages and severe sooting outside the fireplace.

The transmitter operates on 2 AAA batteries.

Key Settings

ON - Operates unit to on position, manually operated solenoid ON.

OFF - Operates unit to off position, manually operated solenoid OFF.

MODE - Changes unit from manual mode to thermo mode.

SET - Sets temperature in thermo mode.

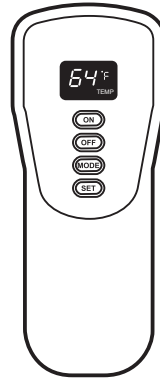

Figure 22 - Remote Control

LCD Liquid Crystal Display

1. **DISPLAY** Indicates CURRENT room temperature.
2. **°F or °C** Indicates degrees Fahrenheit or Celsius.
3. **FLAME** Indicates burner/valve in operation.
4. **ROOM** Indicates remote is in THERMO operation.
5. **TEMP** Appears during manual operation.
6. **SET** Appears during time the of setting the desired temperature in the thermo operation.

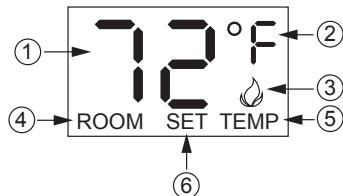

Figure 23 - Remote Control Display

OPERATION

Setting °F/°C Scale

The factory setting for temperature is °F. To change this setting to °C, press the ON key and the OFF key on the remote control at the same time (see Figure 22, page 18). This will change from °F to °C. Follow this same procedure to change from °C back to °F.

Manual Function

To operate the system in the manual "MODE" do the following.

ON OPERATION

Press the ON key and the appliance flame will come on. During this time the LCD screen will show ON (see Figure 24).

After 3 seconds the LCD screen will default to display room temperature and the word TEMP will show (see Figure 24). The flame icon will appear on LCD screen in manual on mode.

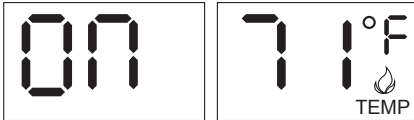

Figure 24 - Manual Mode in ON Operation

OFF OPERATION

Press the OFF key and the appliance flame will shut off. During this time the LCD screen will show OF (see Figure 25).

After 3 seconds the LCD screen will default to display room temperature and the word TEMP will show (see Figure 25).

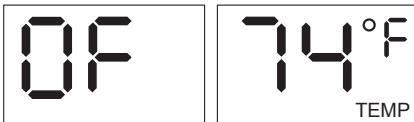

Figure 25 - Manual Mode in OFF Operation

THERMOSTAT FUNCTION

Setting Desired Room Temperature

The remote control system can control the thermostat when the transmitter is in the THERMO mode. The word ROOM must be displayed on the screen.

To set the THERMO MODE and desired room temperature:

1. Press the MODE key until the LCD screen shows the word ROOM. The remote is now in the thermostatic mode.

2. Press and hold the SET key until the desired set temperature is reached. The LCD screen set numbers will increase from 45° to 99° and then restart over at 45°.
3. Release the SET key. The LCD screen will display the set temperature for 3 seconds, then flash the set temperature for 3 seconds, then LCD screen will default to display the room temperature.

To Change The Set Temperature

1. Press and hold the SET key until the desired set temperature is reached. The LCD screen set numbers will increase from 45° to 99° then restart over at 45°.
2. Release the SET key. The LCD screen will display the set temperature for 3 seconds, then flash the set temperature for 3 seconds, then the LCD screen will default to display the room temperature.
3. Press the MODE key to disengage the thermo mode. The word ROOM on the LCD screen will not show when the thermo is not in operation.

Note: The highest SET temperature is 99°F (32 °C) and the lowest temperature is 45°F (6°C).

REMOTE CONTROL OPERATION NOTES

The Thermo Feature on the transmitter operates the appliance whenever the ROOM TEMPERATURE varies a certain number of degrees from the SET TEMPERATURE.

This variation is called the "swing" or temperature differential. The normal operating cycle of an appliance may be 4 times per hour depending on how well the room or home is insulated from the cold or drafts. The factory setting for the "swing number" is 2. This represents a temperature variation of +/-2°F (1°C) between SET temperature and ROOM temperature, which determines when the fireplace will be activated. The transmitter has ON and OFF manual functions that are activated by pressing either button on the face of the transmitter. When a button on the transmitter is pressed the word ON or OF will appear on the LCD screen to show while the signal is being sent. Upon initial use, there may be a delay of three seconds before the remote receiver will respond to the transmitter. This is part of the system's design.

INSPECTING BURNERS

IMPORTANT: Owner's should check pilot flame pattern and burner flame pattern often. Incorrect flame patterns indicate the need for cleaning (see Care and Maintenance, page 23 or service.

⚠ WARNING: Only a qualified service person should service and repair stove. This includes maintenance requiring replacement or alteration of components.

PILOT FLAME PATTERN

Figure 26 shows a correct pilot flame pattern. Figure 27 shows an incorrect pilot flame pattern. The incorrect pilot flame is not touching the thermocouple. This will cause the thermocouple to cool, which shuts the stove off. If pilot flame pattern is incorrect, as shown in Figure 27

- turn stove off (see To Turn Off Gas to Appliance, page 19)
- see Troubleshooting pages 26 through 29.

⚠ WARNING: If yellow tipping occurs, the pilot should be cleaned.

Notice: Do not mistake orange flames with yellow tipping. Dirt or other fine particles enter the stove and burn causing brief patches of orange flame.

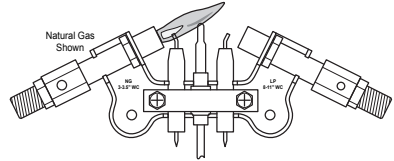

Figure 26 - Correct Pilot Flame Pattern (Natural Gas shown)

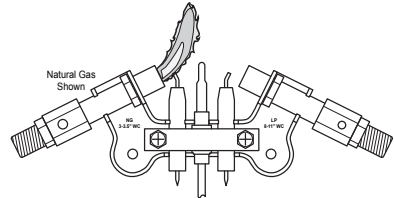

Figure 27 - Incorrect Pilot Flame Pattern (Natural Gas shown)

BURNER FLAME PATTERN

Figure 28 shows a correct burner flame pattern. Figure 29 shows an incorrect burner flame pattern. If burner flame pattern is incorrect as shown in Figure 29:

- turn stove off (see To Turn Off Gas to Appliance, page 19).
- see Troubleshooting pages 26 through 29.

Approx. 3"-6" Above Top of Logs



Figure 28 - Correct Burner Flame Pattern

More Than 8" Above Top of Logs



Figure 29 - Incorrect Burner Flame Pattern

BURNER PRIMARY AIR HOLES

Air is drawn into the burner through the holes in the fitting at the entrance to the burner. These holes may become blocked with dust or lint. Periodically inspect these holes for any blockage and clean as necessary. Blocked air holes will create soot.

CARE AND MAINTENANCE

⚠ WARNING: Turn off stove and let cool before servicing.

⚠ CAUTION: You must keep control areas, burner, and circulating air passageways of stove clean. Inspect these areas of stove before each use. Have stove inspected yearly by a qualified service technician. Stove may need more frequent cleaning due to excessive lint from carpeting, bedding material, pet hair, etc.

⚠ WARNING: Failure to keep the primary air opening(s) of the burner(s) clean may result in sooting and property damage.

MAIN BURNER

Periodically inspect all burner flame holes with the stove running. All slotted burner flame holes should be open with yellow flame present. All round burner flame holes should be open with a small blue flame present. Some

burner flame holes may become blocked by debris or rust, with no flame present. If so, turn off the stove and let it cool, and remove blockage or replace burner. Blocked burner flame holes will create soot.

BURNER INJECTOR HOLDER AND PILOT AIR INLET HOLE

We recommend that you clean the unit every 2,500 hours of operation or every three months. We also recommend that you keep the burner tube and pilot assembly clean and free of dust and dirt. To clean these parts we recommend using compressed air no greater than 30 PSI. Your local computer store, hardware store, or home center may carry compressed air in a can. You can use a vacuum cleaner in the blow position. If using compressed air in a can, please follow the directions on the can. If you don't follow directions on the can, you could damage the pilot assembly.

1. Shut off the unit, including the pilot. Allow the unit to cool for at least thirty minutes.
2. Inspect burner, pilot and primary air inlet holes on injector for dust and dirt (see Figure 30).
3. Blow air through the ports/slots and holes in the burner. Also clean the pilot assembly.

4. Check the injector holder located at the end of the burner tube again. Remove any large particles of dust, dirt, lint, or pet hair with a soft cloth or vacuum cleaner nozzle.
5. Blow air into the primary air holes on the injector holder.
6. In case any large clumps of dust have now been pushed into the burner. Repeat steps 3 and 4.

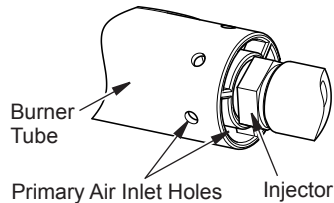

Figure 30 - Burner and Injector Holder

CARE AND MAINTENANCE

ODS/PILOT

⚠ CAUTION: Never use a wire, needle, or similar object to clean ODS/pilot. This can damage ODS/ pilot unit.

Use a vacuum cleaner, pressurized air, or a small, soft bristled brush to clean.

A yellow tip on the pilot flame indicates dust and dirt in the pilot assembly. There is a small pilot air inlet hole about 2" from where the pilot flame comes out of the pilot assembly (see Figure 31). With the unit off, lightly blow air through the air inlet hole. You may blow through a drinking straw if compressed air is not available.

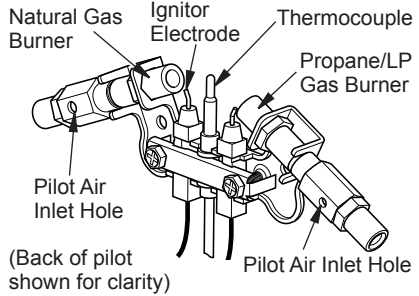

Figure 31 - Pilot Inlet Air Hole

CABINET

Air Passageways

Use a vacuum cleaner or pressurized air to clean.

Exterior

- Use a soft cloth dampened with a mild soap and water mixture.
- Wipe the cabinet to remove dust.

LOGS

- If you remove logs for cleaning, refer to [Installing Logs](#), page 16, to properly replace logs.
- Replace log(s) if broken or chipped (dime-size or larger).

ELECTRICAL

ELECTRICAL CONNECTION

FOR STOVES EQUIPPED WITH A BLOWER

⚠ Do not use this stove if any part of it has been under water. Immediately call a qualified service technician to inspect the stove and replace any part of the electrical system which has been under water.

GROUNDING INSTRUCTIONS

This stove is for use on 120 volts. The cord has a plug as shown at A in Figure 32. An adapter as shown at C is available for connecting three-blade grounding-type plugs to two-slot receptacles. The green grounding lug extending from the adapter must be connected to a permanent ground such as

a properly grounded outlet box. The adapter should not be used if a three-slot grounded receptacle is available.

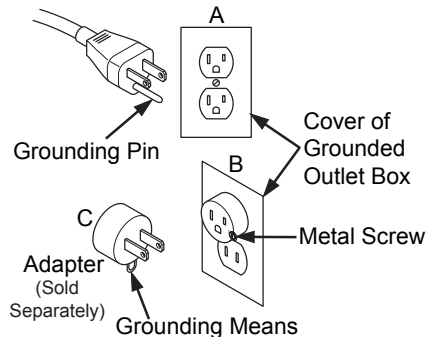

Figure 32 - Grounded Electrical Outlet

ELECTRICAL

ELECTRICAL WIRING

Any electrical re-wiring of this stove must be done by a qualified electrician. This wiring must be done in accordance with local codes and/or in Canada with the current CSA C22.1 *Canadian Electrical Code*, and for US installations, the *National Electrical Code ANSI/NFPA NO 70*.

⚠ WARNING: If repairing or replacing any electrical component or wiring, the original wire routing, color coding and securing locations must be followed.

⚠ CAUTION: Label all wires prior to disconnection when servicing controls. Wiring errors can cause improper and dangerous operation.

⚠ WARNING: Never attempt to service stove while it is plugged in, operating, or hot. Burns and electrical shock could result. Only a qualified service person should service or repair stove.

Verify proper operation after servicing. If any of the original wire as supplied with the stove must be replaced, it must be replaced with a wire of at least a 105° C temperature rating.

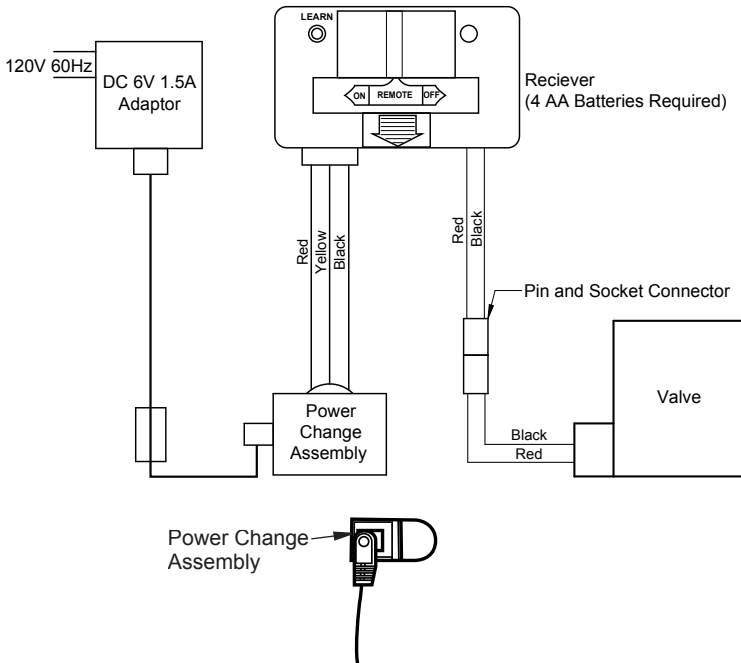

TROUBLESHOOTING

⚠ WARNING: If you smell gas:

- Shut off gas supply.
- Do not try to light any appliance.
- Do not touch any electrical switch; do not use any phone in your building.
- Immediately call your gas supplier from a neighbor's phone. Follow the gas supplier's instructions.
- If you cannot reach your gas supplier, call the fire department.

⚠ WARNING: Only a qualified service technician should service and repair stove. Make sure that power is turned off before proceeding. Turn off and let cool before servicing.

IMPORTANT: Operating stove where impurities in air exist may create odors. Cleaning supplies, paint, paint remover, cigarette smoke, cements and glues, new carpet or textiles, etc., create fumes. These fumes may mix with combustion air and create odors.

Note: All troubleshooting items are listed in order of operation.

Problem	Possible Cause	Corrective Action
Using natural gas and pilot will not light.	Inlet pressure exceeds 9" WC.	Bypass pressure switch. See instructions below.

Pressure Switch

When using natural gas (NG), there is a pressure switch that acts to turn off the gas flow to the pilot if the inlet pressure exceeds 9" WC. This is to prevent the operation of the unit on the wrong gas (propane/LP). If your natural gas supply exceeds 9" WC the unit will not operate. Either contact your gas supplier to check and adjust the inlet pressure or a qualified service technician can bypass the pressure switch.

Before attempting to bypass the pressure switch, make sure the type of gas being used is correct. Check to make sure the connection fitting is in the correct inlet on the regulator. Refer to *Connecting to Gas Supply*, page 12.

Only a qualified installer should bypass the pressure switch. To bypass the pressure switch locate the set screw on the regulator. Use a small flat bladed screw driver to turn the set screw counterclockwise 2 turns. This will bypass the pressure switch function.

The entire gas delivery piping including connections inside the stove should be leak tested by the qualified installer. After leak testing the qualified installer should light the appliance. Refer to the correct flame pattern as illustrated on page 22. All flame patterns should be safely inside the product. If for any reason they are not, stop use of the appliance and call for repairs.

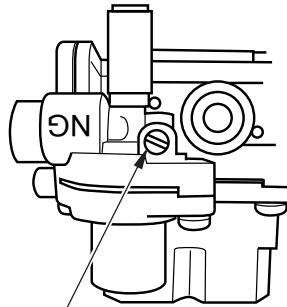

Pressure Switch Set Screw

Figure 33 - Gas Regulator Pressure Switch

TROUBLESHOOTING

Problem	Possible Cause	Corrective Action
When ignitor button is pressed in, there is no spark at ODS/pilot	<ol style="list-style-type: none"> 1. Ignitor electrode is positioned wrong. Ignitor electrode is broken. 2. Ignitor electrode is not connected to ignitor cable. 3. Ignitor cable is pinched or wet. 4. Broken ignitor cable. 5. Bad piezo ignitor. 6. Low battery. 	<ol style="list-style-type: none"> 1. Replace electrode. 2. Replace ignitor cable 3. Free ignitor cable if pinched by any metal or tubing. Keep ignitor cable dry. 4. Replace ignitor cable. 5. Replace piezo ignitor. 6. Replace battery.
When ignitor button is pressed in there is a spark at ODS/pilot but no ignition.	<ol style="list-style-type: none"> 1. Gas supply is turned off or equipment shutoff valve is closed. 2. Control knob not fully pressed in while pressing ignitor button. 3. Air in gas lines (new installation or recent gas interruption). 4. ODS / pilot is clogged. 5. Incorrect inlet gas pressure or inlet regulator is damaged. 6. Control knob not in PILOT position. 7. Depleted gas supply (propane). 	<ol style="list-style-type: none"> 1. Turn on gas supply or open equipment shutoff valve. 2. Fully press in control knob while pressing ignitor button. 3. Continue holding down control knob. Repeat igniting operation until air is removed. 4. Clean ODS/pilot (see <u>Care and Maintenance</u>, page 23) or replace ODS/pilot assembly. 5. Check inlet gas pressure or replace inlet gas regulator. 6. Turn control knob to PILOT position. 7. Contact local propane/LP gas company.
ODS/pilot lights but flame goes out when control knob is released.	<ol style="list-style-type: none"> 1. Control knob is not fully pressed in. 2. Control knob is not pressed in long enough. 3. Equipment shutoff valve is not fully open. 4. Thermocouple connection is loose at control valve. 5. Pilot flame not touching thermocouple, which allows thermocouple to cool, causing pilot flame to go out. This problem could be caused by one or both of the following: A) Low gas pressure B) Dirty or partially clogged ODS/pilot 6. Thermocouple damaged. 7. Control valve damaged. 	<ol style="list-style-type: none"> 1. Press in control knob fully. 2. After ODS/pilot lights, keep control knob pressed in 30 seconds. 3. Fully open equipment shutoff valve. 4. Hand tighten until snug, and then tighten 1/4 turn more. 5. A) Contact local natural or propane/LP gas company B) Clean ODS/pilot (see <u>Care and Maintenance</u>, page 23) or replace ODS/pilot assembly 6. Replace thermocouple. 7. Replace control valve.

TROUBLESHOOTING

Problem	Possible Cause	Corrective Action
Burner(s) does not light after ODS/pilot is lit	<ol style="list-style-type: none"> 1. Burner orifice is clogged. 2. Burner orifice diameter is too small. 3. Inlet gas pressure is too low. 	<ol style="list-style-type: none"> 1. Clean burner orifice (see <i>Care and Maintenance</i>, page 23) or replace burner orifice. 2. Replace burner orifice. 3. Contact local gas supplier.
Delayed ignition of burner(s).	<ol style="list-style-type: none"> 1. Manifold pressure is too low. 2. Burner orifice is clogged. 	<ol style="list-style-type: none"> 1. Contact local gas supplier. 2. Clean burner (see <i>Care and Maintenance</i>, page 23) or replace burner orifice.
Burner backfiring during combustion.	<ol style="list-style-type: none"> 1. Burner orifice is clogged or damaged. 2. Burner is damaged. 3. Gas regulator is damaged. 	<ol style="list-style-type: none"> 1. Clean burner orifice (see <i>Care and Maintenance</i>, page 23) or replace burner orifice. 2. Contact dealer or customer service. 3. Replace gas regulator.
High yellow flame during burner combustion.	<ol style="list-style-type: none"> 1. Not enough air. 2. Gas regulator is defective. 3. Inlet gas pressure is too low. 	<ol style="list-style-type: none"> 1. Check burner for dirt and debris. If found, clean burner (see <i>Care and Maintenance</i>, page 23). 2. Replace gas regulator. 3. Contact local gas supplier.
Gas odor during combustion.	<ol style="list-style-type: none"> 1. Foreign matter between control valve and burner. 2. Gas leak. (See <i>Warning Statement</i> at top of page 26). 	<ol style="list-style-type: none"> 1. Take apart gas tubing and remove foreign matter. 2. Locate and correct all leaks (see <i>Checking Gas Connections</i>, page 14).
Slight smoke or odor during initial operation.	<ol style="list-style-type: none"> 1. Residues from manufacturing process. 	<ol style="list-style-type: none"> 1. Problem will stop after a few hours of operation.
Heater produces a whistling noise when burner is lit.	<ol style="list-style-type: none"> 1. Turning control knob to high position when burner is cold. 2. Air in gas line. 3. Air passageways on heater are blocked. 4. Dirty or partially clogged burner orifice. 	<ol style="list-style-type: none"> 1. Turn control knob to low position and let warm up for a minute. 2. Operate burner until air is removed from line. Have gas line checked by local gas supplier. 3. Observe minimum installation clearances (Figure 7, page 9) 4. Clean burner (see <i>Care and Maintenance</i>, page 23) or replace burner orifice.
Heater produces a clicking/ticking noise just after burner is lit or shut off.	<ol style="list-style-type: none"> 1. Metal is expanding while heating or contracting while cooling. 	<ol style="list-style-type: none"> 1. This is common with most heaters. If noise is excessive, contact qualified service technician.
White powder residue forming within burner box or on adjacent walls or furniture.	<ol style="list-style-type: none"> 1. When heated, the vapors from furniture polish, wax, carpet cleaners, etc., turn into white powder residue. 	<ol style="list-style-type: none"> 1. Turn heater off when using furniture polish, wax, carpet cleaner or similar products.

TROUBLESHOOTING

Problem	Possible Cause	Corrective Action
Heater produces unwanted odors.	<ol style="list-style-type: none"> 1. Heater is burning vapors from paint, hair spray, glues, etc. See IMPORTANT statement, page 26. 2. Gas leak. See <i>Warning Statement</i> at the top of page 26. 3. Low fuel supply. 	<ol style="list-style-type: none"> 1. Ventilate room. Stop using odor causing products while heater is running. 2. Locate and correct all leaks (see <i>Checking Gas Connections</i>, page 14). 3. Refill supply tank (Propane/LP models).
Heater shuts off in use (ODS operates).	<ol style="list-style-type: none"> 1. Not enough fresh air is available. 2. Low line pressure. 3. ODS/pilot is partially clogged. 	<ol style="list-style-type: none"> 1. Open window and/or door for ventilation. 2. Contact local gas supplier. 3. Clean ODS/pilot (see <i>Care and Maintenance</i>, page 23).
Gas odor exists even when control knob is in OFF position.	<ol style="list-style-type: none"> 1. Gas leak. See <i>Warning Statement</i> at top of page 26. 2. Control valve is defective. 	<ol style="list-style-type: none"> 1. Locate and correct all leaks (see <i>Checking Gas Connections</i>, page 14). 2. Replace control valve.
Moisture/condensation noticed on windows.	<ol style="list-style-type: none"> 1. Not enough combustion/ventilation air. 	<ol style="list-style-type: none"> 1. Refer to <i>Air for Combustion and Ventilation</i> requirements, page 7.

SERVICE HINTS

When Gas Pressure Is Too Low

- pilot will not stay lit
- burners will have delayed ignition
- stove will not produce specified heat
- propane/LP gas supply might be low (propane/LP units only)

You may feel your gas pressure is too low. If so, contact your local gas supplier.

TECHNICAL SERVICE

You may have further questions about installation, operation, or troubleshooting. If so, contact Factory Buys Direct at 1-855-607-6557.

When calling, please have your model and serial numbers of your stove ready.

ACCESSORIES

To purchase heater accessories and parts call Factory Buys Direct at 1-855-607-6557. Visit us online at www.factorybuysdirect.com for a complete selection accessories.

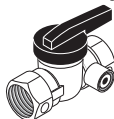

EQUIPMENT SHUTOFF VALVE

For all models.

QEB100 - BLOWER ACCESSORY

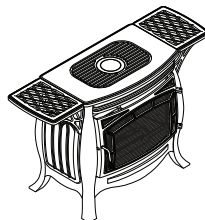

FDSR25SS - SIDE SHELF KIT

PARTS

MODEL FDSR25 & FDSR25GF

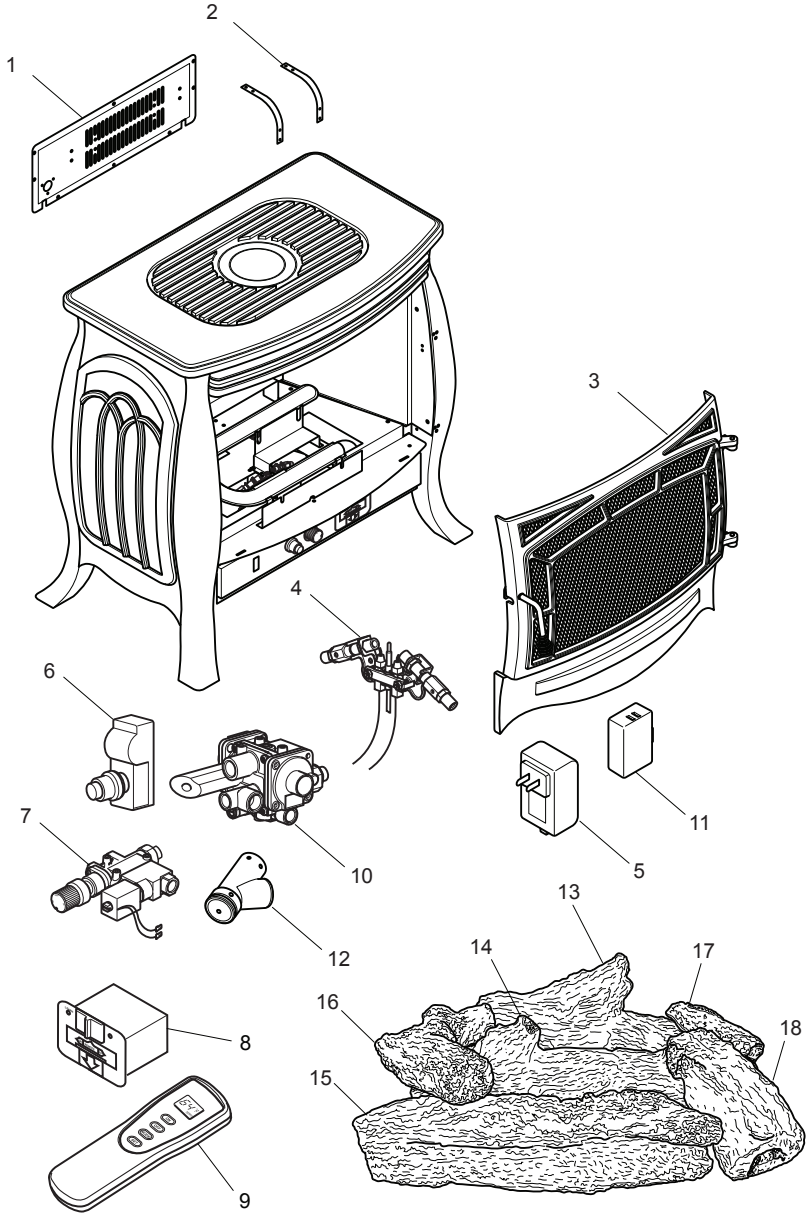

PARTS

MODELS FDSR25 & FDSR25GF

This list contains replaceable parts for your stove. When ordering replacement parts, follow the instructions listed under Replacement Parts.

Item	Part #	Description	Qty
1	BL016-07	Blower Mount Panel	1
2	SL005-01A	Blower Bracket	2
3	**	Door Assembly	1
4	ND0310A-400-P-PU2	ODS Pilot	1
5	QX18W060150FU	6V DC Adapter	1
6	PIMDNI-01	Piezo Ignitor	1
7	MRT-01	EIV Controller	1
8	RG04-2M	Remote Receiver	1
9	RG04-1T	Remote Control	1
10	RVD88-Y-4/9	Safety Dual Fuel Regulator	1
11	RG04-1M-PA	Power Change Assembly	1
12	RVD88-YJ	Elbow Connection	1
	SSU220R500	Log Set	1
13	SSU220R501	Log 1	1
14	SSU220R502	Log 2	1
15	SSU220R503	Log 3	1
16	SSU220R504	Log 4	1
17	SSU220R505	Log 5	1
18	SSU220R506	Log 6	1
Parts Available - Not Shown			
	WYL601-01	Hardware Package	1
	PCAM-012	AAA Battery	1

REPLACEMENT PARTS

Note: Use only original replacement parts. This will protect your warranty coverage for parts replaced under warranty.

PARTS UNDER WARRANTY

Contact authorized dealers of this product. If they can't supply original replacement parts, call Customer Service toll free at 1-855-607-6557 for referral information.

When calling Customer Service or your dealer, have ready:

- Your name

- Your address
- Model and serial number of your stove
- How stove was malfunctioning
- Type of gas supply and Propane/LP tank size
- Purchase date

Usually, we will ask you to return the defective part to the factory

PARTS NOT UNDER WARRANTY

Contact authorized dealers of this product. If they can't supply original replacement part(s) call Customer Service toll free at 1-855-607-6557 for referral information.

When calling Customer Service have ready:

- Model number of your stove
- The replacement part number

WARRANTY

KEEP THIS WARRANTY

Model _____

Serial No. _____

Date Purchased _____

Keep receipt for warranty verification.

REGISTER YOUR PRODUCT AT WWW.FACTORYBUYSDIRECT.COM FACTORY BUYS DIRECT LIMITED WARRANTIES

New Products

Standard Warranty: Factory Buys Direct warrants this new product and any parts thereof to be free from defects in material and workmanship for a period of one (1) year from the date of first purchase from an authorized dealer provided the product has been installed, maintained and operated in accordance with Factory Buys Direct's warnings and instructions.

For products purchased for commercial, industrial or rental usage, this warranty is limited to 90 days from the date of first purchase.

Factory Reconditioned Products

Limited Warranty: Factory Buys Direct warrants factory reconditioned products and any parts thereof to be free from defects in material and workmanship for a period 30 days from the date of first purchase from an authorized dealer provided the product has been installed, maintained and operated in accordance with Factory Buys Direct's warnings and instructions. No return will be authorized. Parts will be provided to repair the product.

Terms Common to All Warranties

The following terms apply to all of the above warranties:

Always specify model number and serial number when contacting the manufacturer. To make a claim under this warranty, the bill of sale or other proof of purchase must be presented.

This warranty is extended only to the original retail purchaser when purchased from an authorized dealer, and only when installed by a qualified installer in accordance with all local codes and instructions furnished with this product.

This warranty covers the cost of part(s) required to restore this product to proper operating condition and an allowance for labor when provided by a Factory Buys Direct Authorized Service Center or a provider approved by Factory Buys Direct. Warranty parts must be obtained through authorized dealers of this product and/or Factory Buys Direct who will provide original factory replacement parts. Failure to use original factory replacement parts will void this warranty.

Traveling, handling, transportation, diagnostic, material, labor and incidental costs associated with warranty repairs, unless expressly covered by this warranty, are not reimbursable under this warranty and are the responsibility of the owner.

Excluded from this warranty are products or parts that fail or become damaged due to misuse, accidents, improper installation, lack of proper maintenance, tampering or alteration(s).

This is Factory Buys Direct's exclusive warranty, and to the full extent allowed by law; this express warranty excludes any and all other warranties, express or implied, written or verbal and limits the duration of one and all implied warranties, including warranties of merchantability and fitness for a particular purpose to one (1) year on new products and 30 days on factory reconditioned products from the date of first purchase.

Factory Buys Direct makes no other warranties regarding this product.

Factory Buys Direct's liability is limited to the purchase price of the product and Factory Buys Direct shall not be liable for any other damages whatsoever under any circumstances including direct, indirect, incidental, or consequential damages.

Some states do not allow limitations on how long an implied warranty lasts or the exclusion or limitation of incidental or consequential damages, so the above limitation or exclusion may not apply to you.

This warranty gives you specific legal rights, and you may also have other rights which vary from state to state.



**FACTORY
BUYS
DIRECT.COM**

Factory Buys Direct
500 Brown Industrial Parkway
Canton, GA 30114
1-855-607-6557

200257-01
Rev. A
07/15