

ASSEMBLY INSTRUCTIONS

3-SLIDE WARDROBE

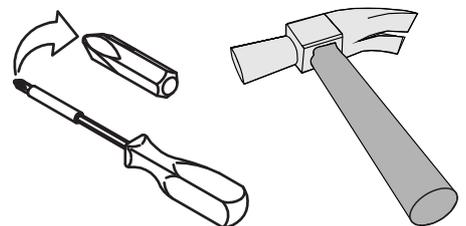
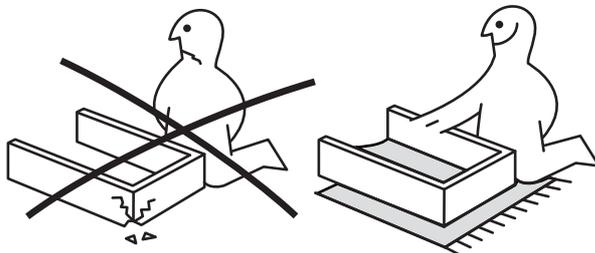
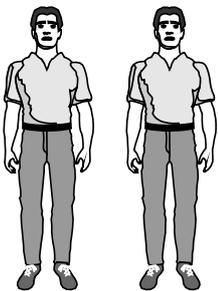
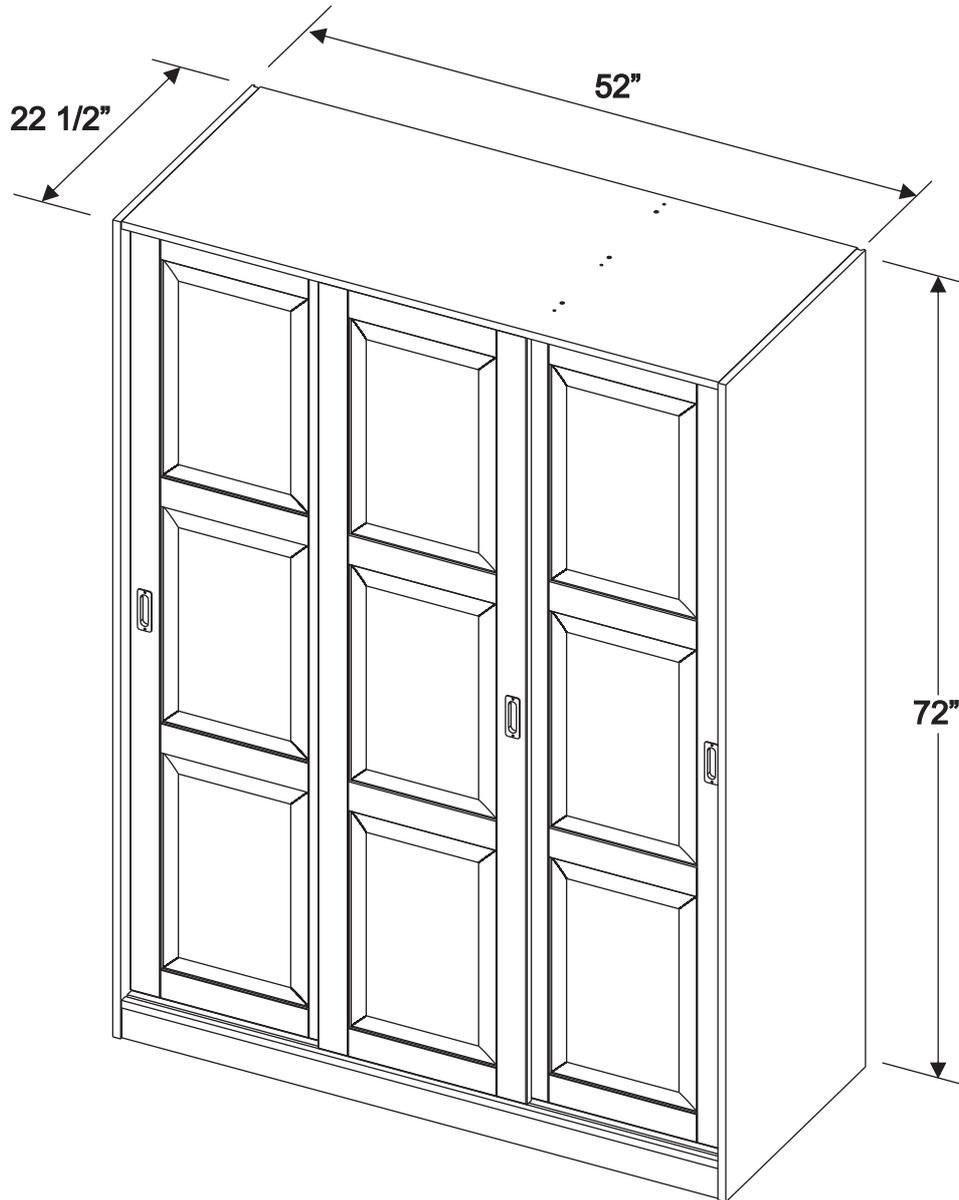

IMPORTANT:

READ THESE INSTRUCTIONS CAREFULLY BEFORE ATTEMPTING TO ASSEMBLE OR USE YOUR FURNITURE.

- Please keep these instructions for future reference.
- Always check that the product is free from damage before use. Do not use your product if any damage is present.
- On unpacking the item you may notice an odour due to the production process. However, this will disappear after a period of time.
- Before you to assemble your product, first check if there are any missing or damaged parts.
- Do Not throw away packaging material until assembly is complete.
- If you organize the items by parts, you'll find it much easier to grab each piece as you build.
- It is best to use any tools the kit provides, such as a hex key, because they may be specially sized for that piece of furniture. We do not recommend the use of power drill, it can damage your furniture if not used correctly.
- This product it should be assembled as near as possible to the point of use. Take care when lifting to avoid personal injury and (or) damage to the product.
- To avoid damages assemble the item on a soft, clean surface.
- Always use on a level, even surface It is recommended that two people handle and assemble the item.
- Do not place the item next to a radiator or direct sunlight – this item is manufactured in pine but is susceptible to temperature change. It is recommended an even room temperature be maintained with no sudden fluctuations.

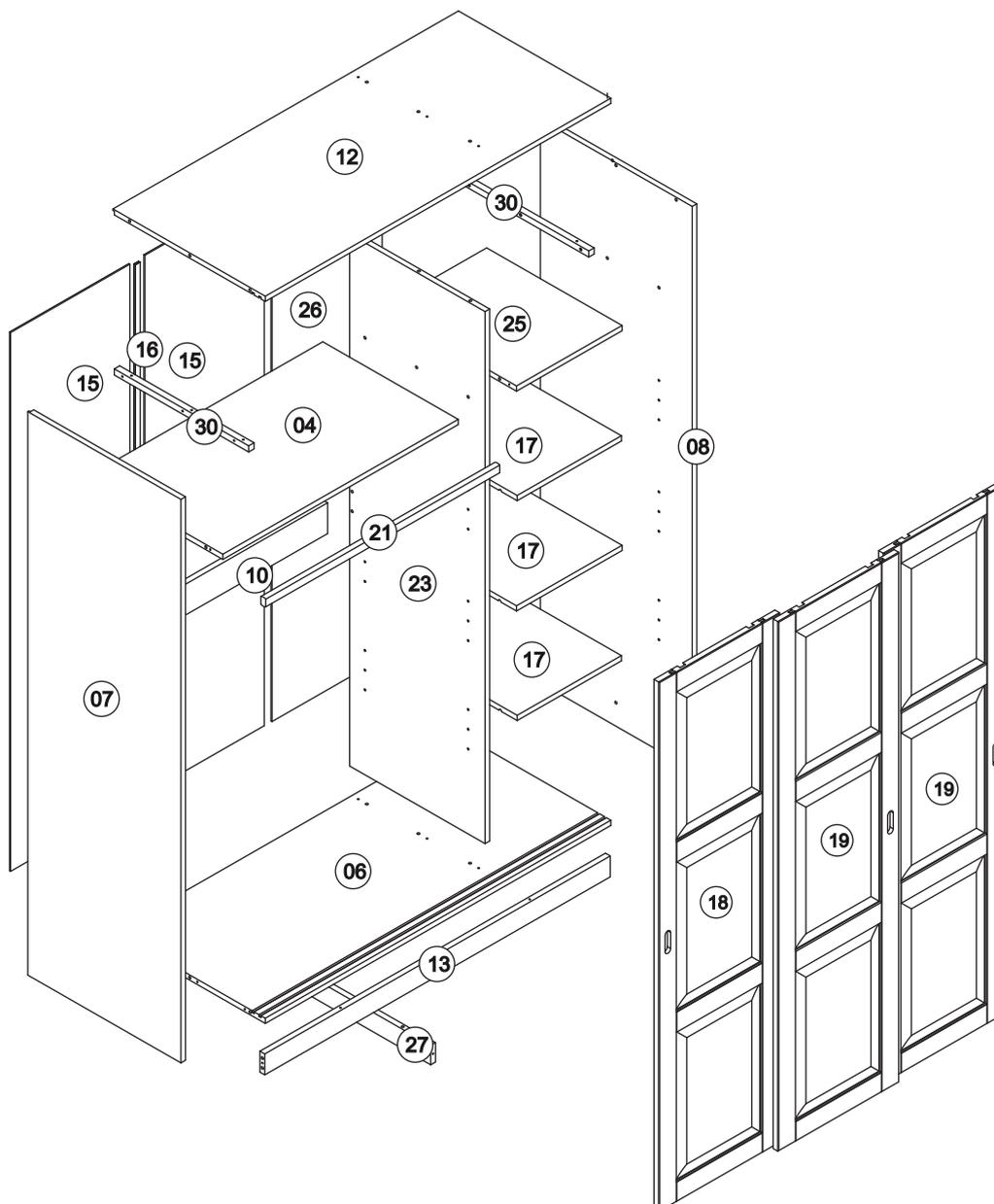

SCREWS ARE SHOWN IN ACTUAL SIZE

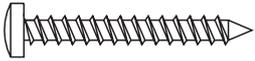
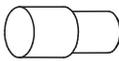
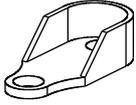
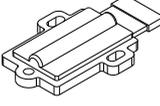
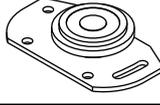
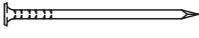
A1	 4,0x30	42+2
A3	 3,0x16	06+1
A4	 3,5x14	04+1
A9	 3,5x16	28+1
A16	 4,0x40	06+1
C2	 8,0x25	44+2
D4	 Metal	12+1
D10		02
D27		05
E15	 DOOR TOP	06
E16	 DOOR BOTTOM	06
G1	 10x10	49
H2		03

WARNING:
CHOKING HAZARD
- Small Parts, not for Children.
To be Assembled by an Adult.

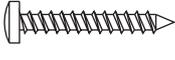
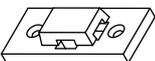
FURNITURE ANTI-TIPPING RESTRAINT KIT		
A8	 3,0x20	02 + 1
F8		02
F9		01

01)

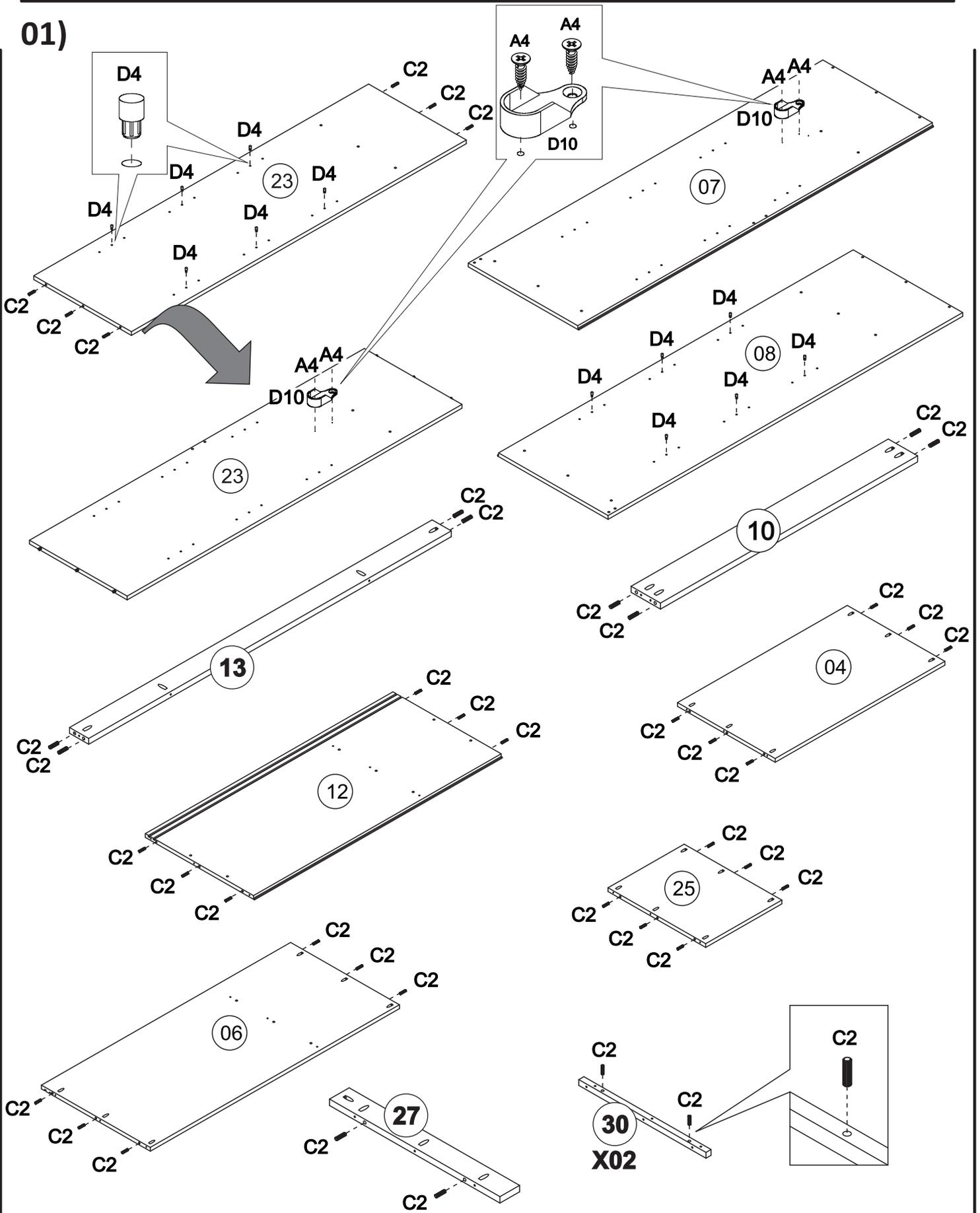

A4	 3,5x14	04	D4		12
C2	 8,0x25	44	D10		02

02)

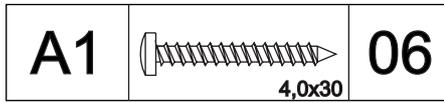
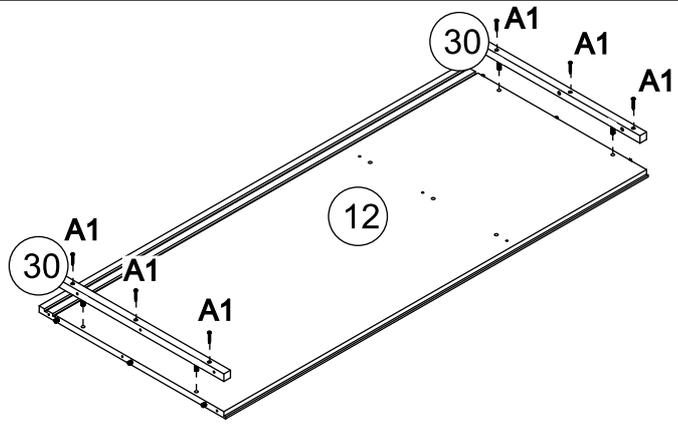

03)

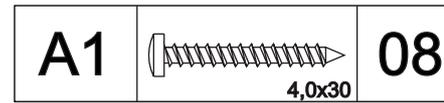
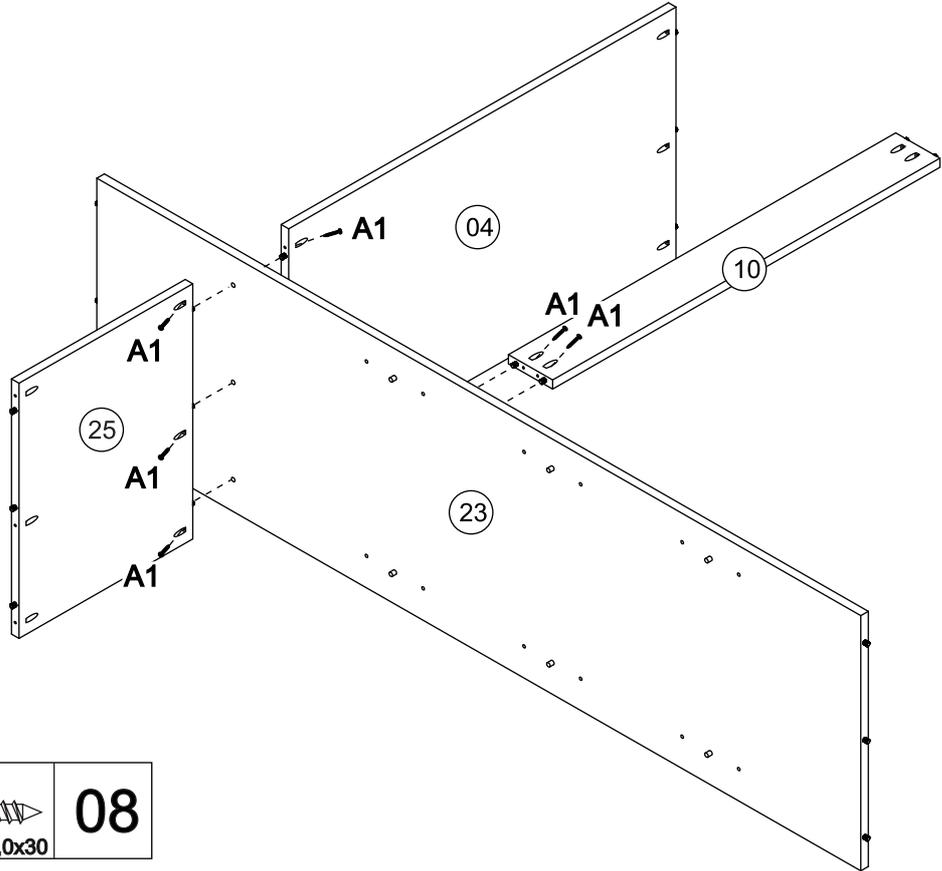

04)

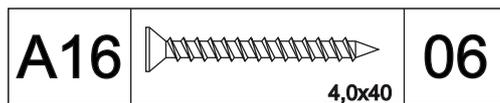
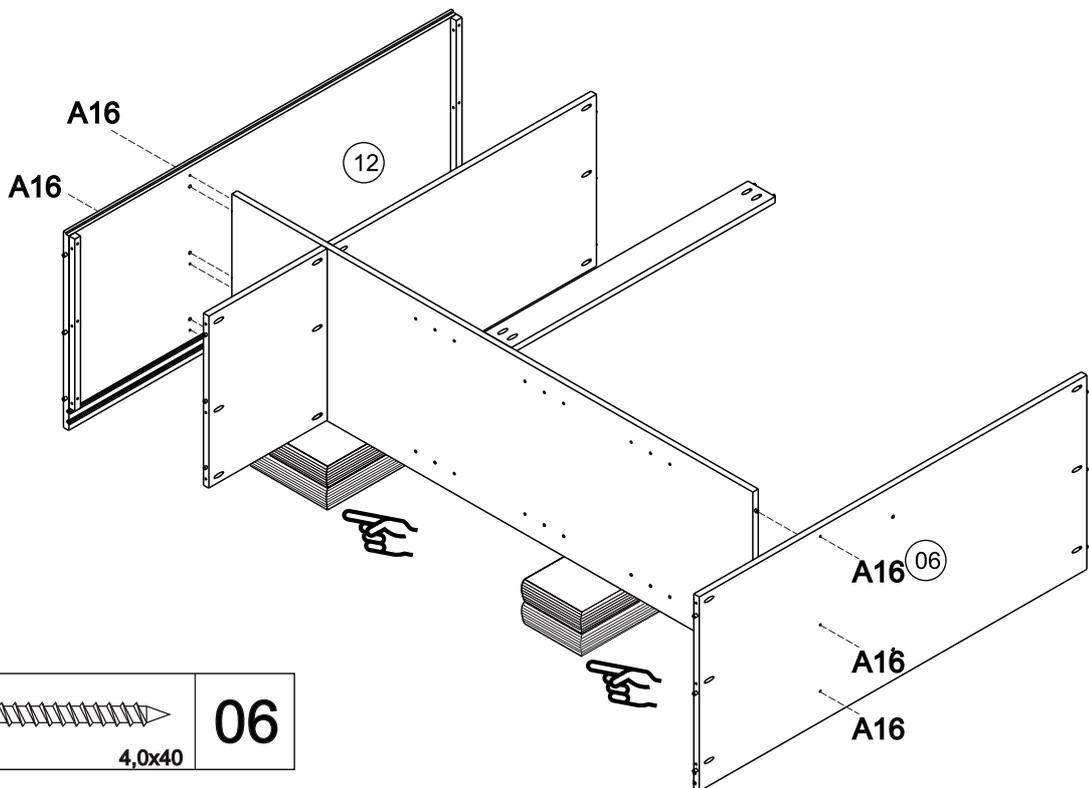

05)

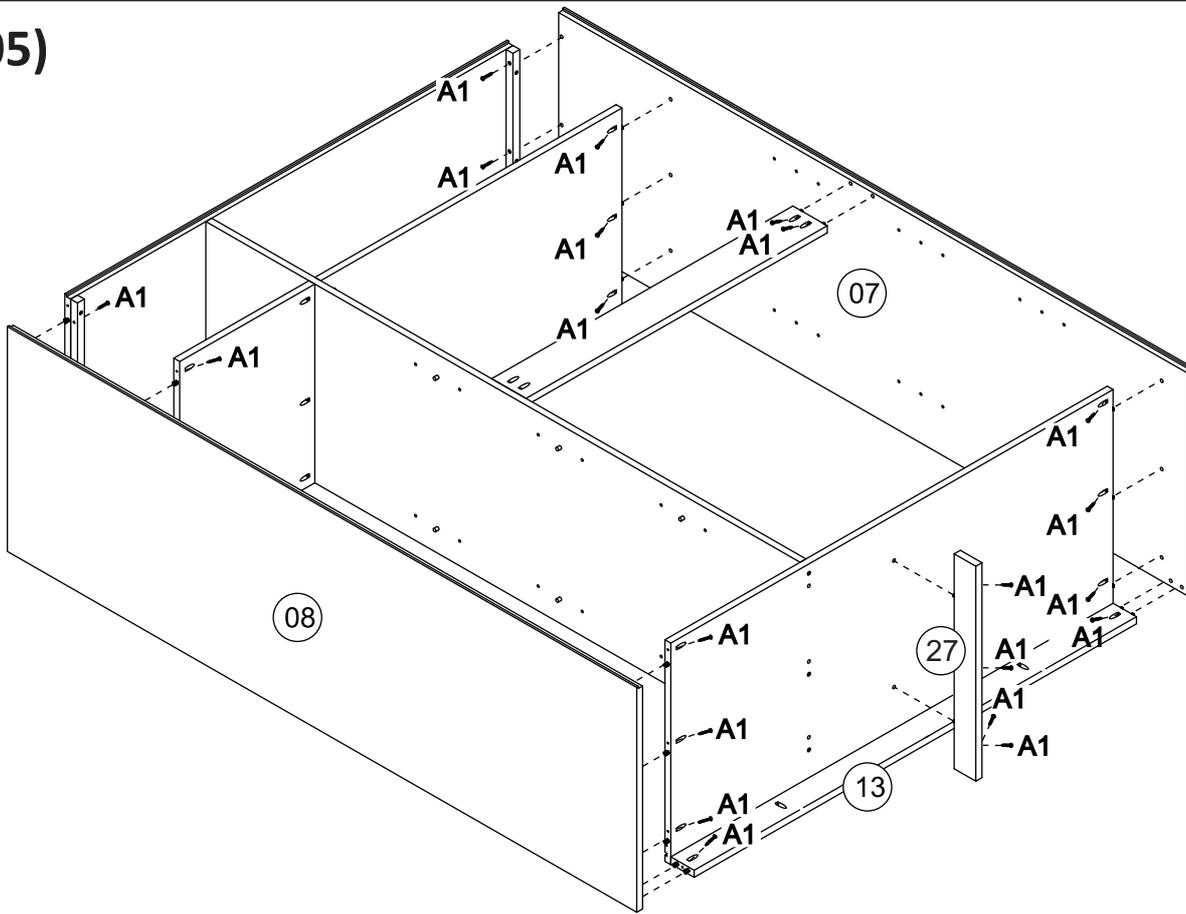

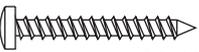
A1	 4,0x30	28
----	---	----

06)

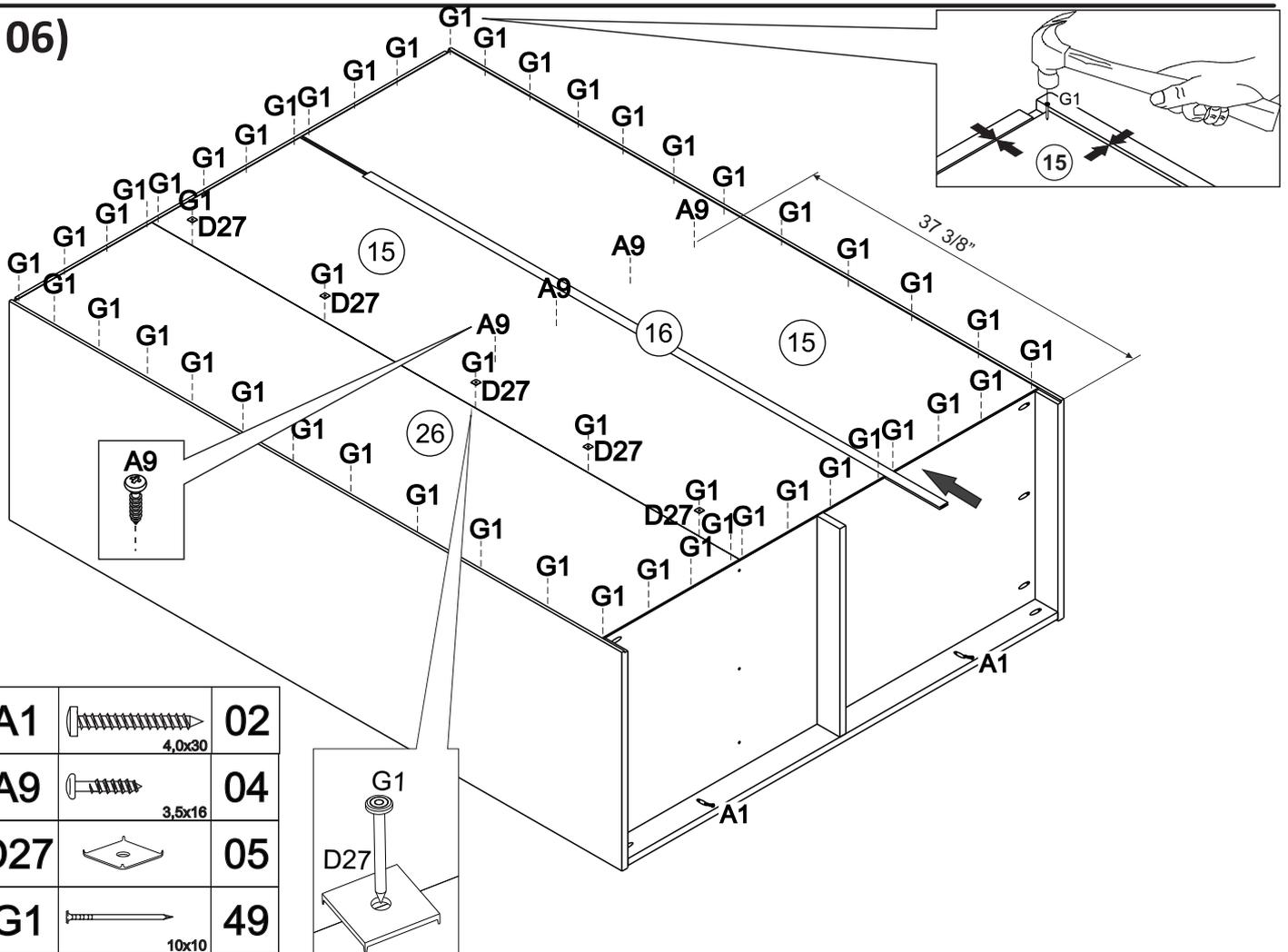

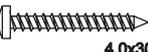
A1	 4,0x30	02
A9	 3,5x16	04
D27		05
G1	 10x10	49

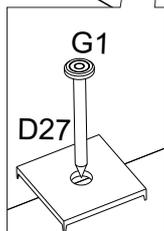

07)

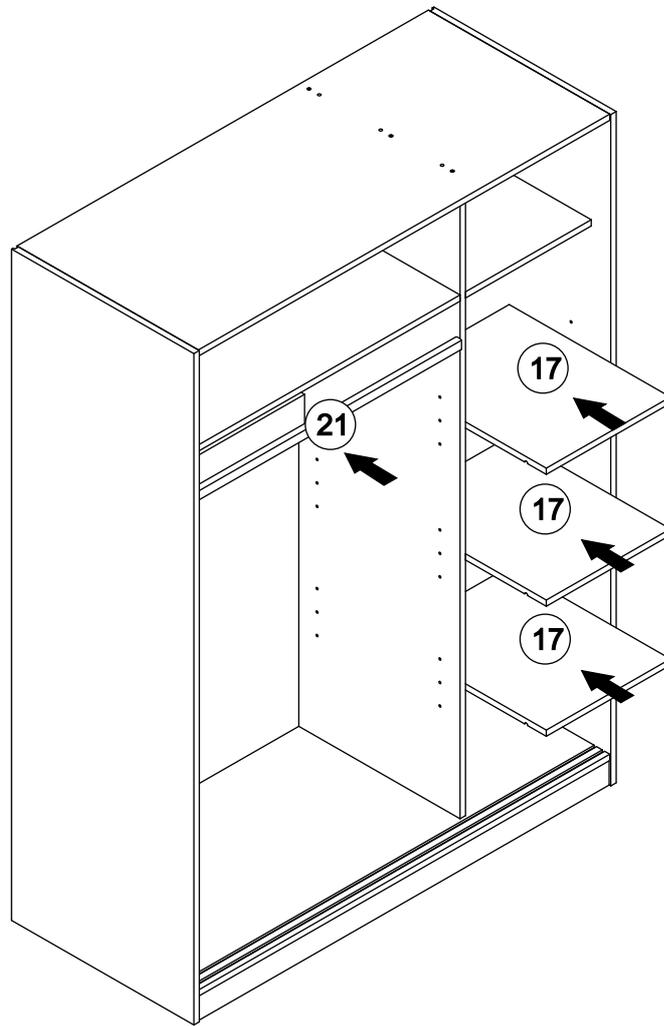

08)

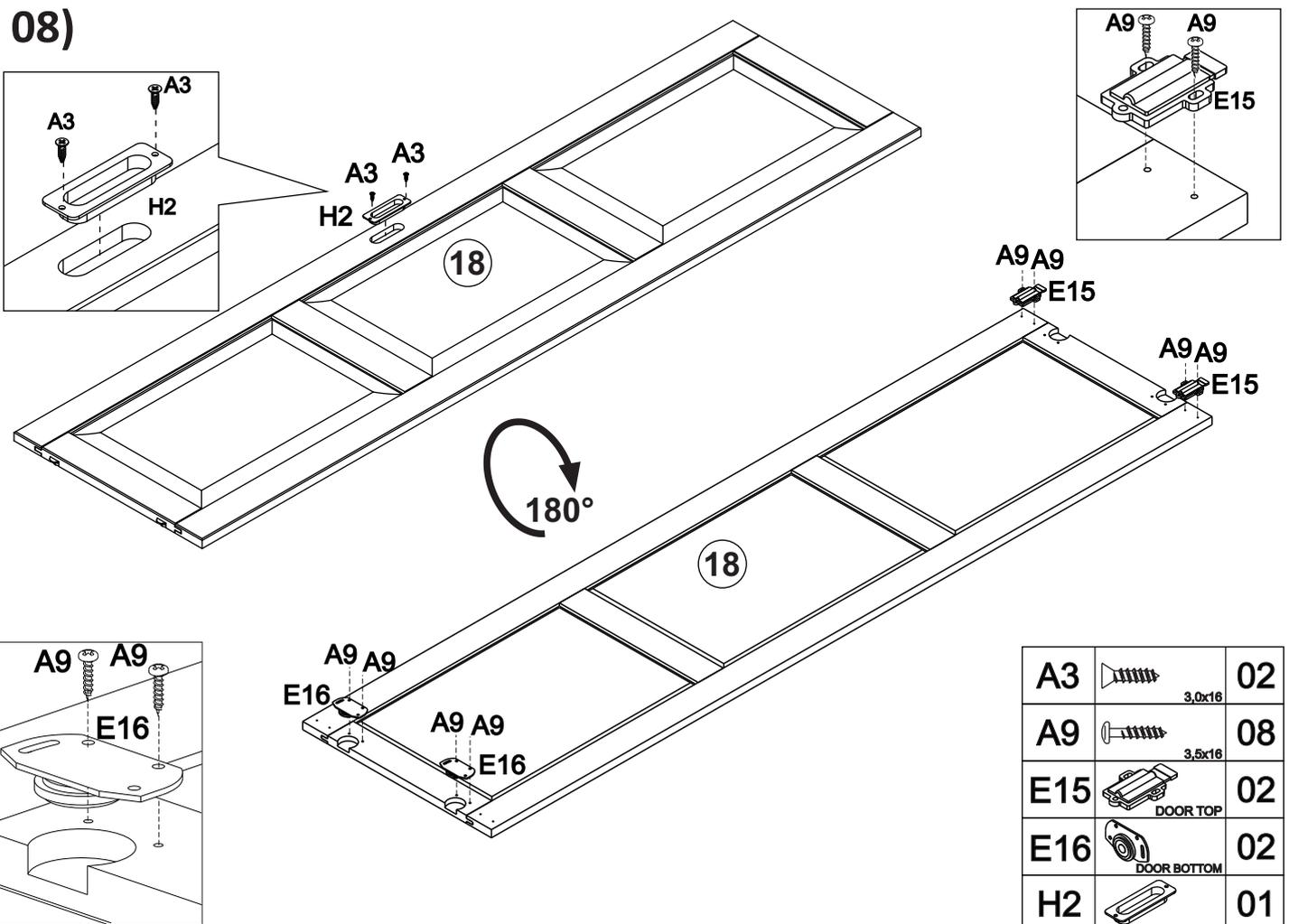

A3		3,0x16	02
A9		3,5x16	08
E15		DOOR TOP	02
E16		DOOR BOTTOM	02
H2			01

09)
2x

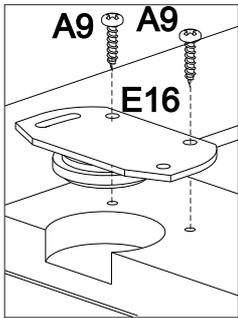
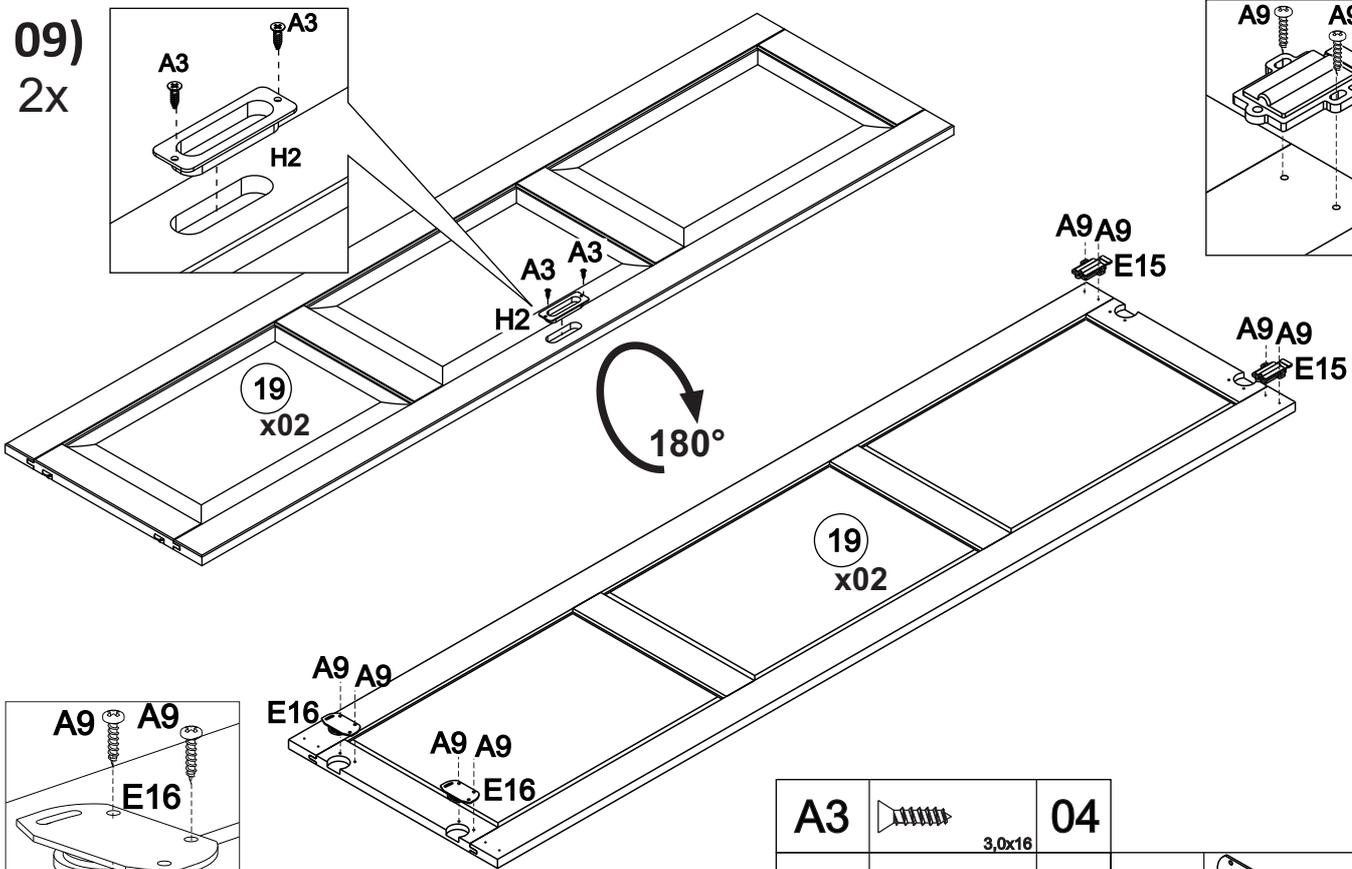
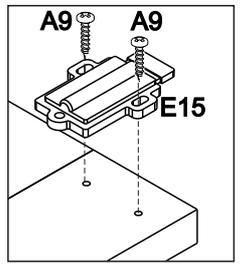
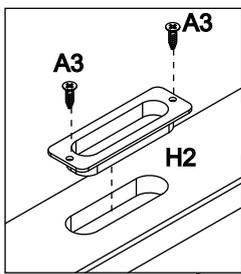

A3		04		
	3,0x16			
A9		16	E16	
	3,5x16			DOOR BOTTOM
E15		02	H2	
	DOOR TOP			

ATTENTION!

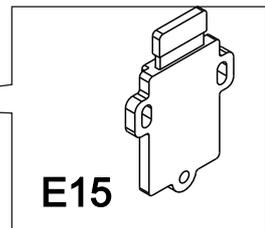
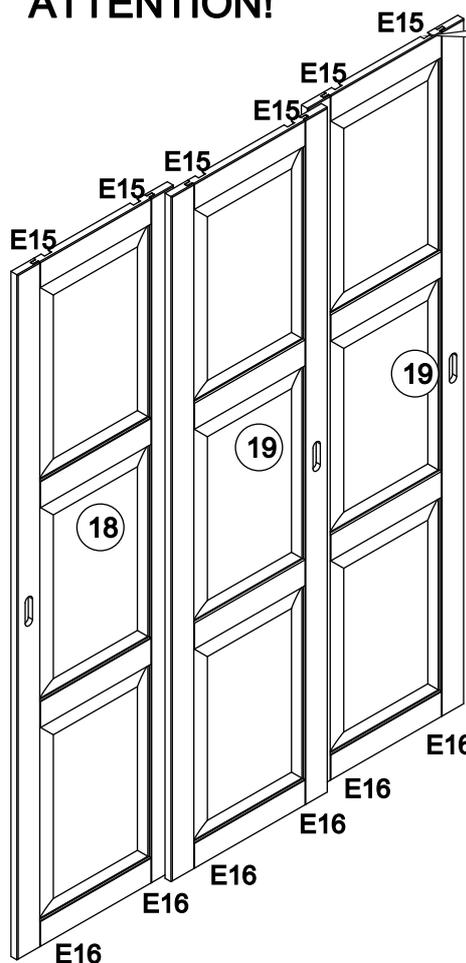

E15

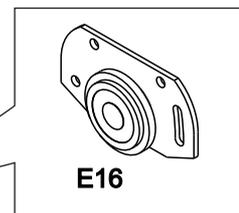

E16

10)

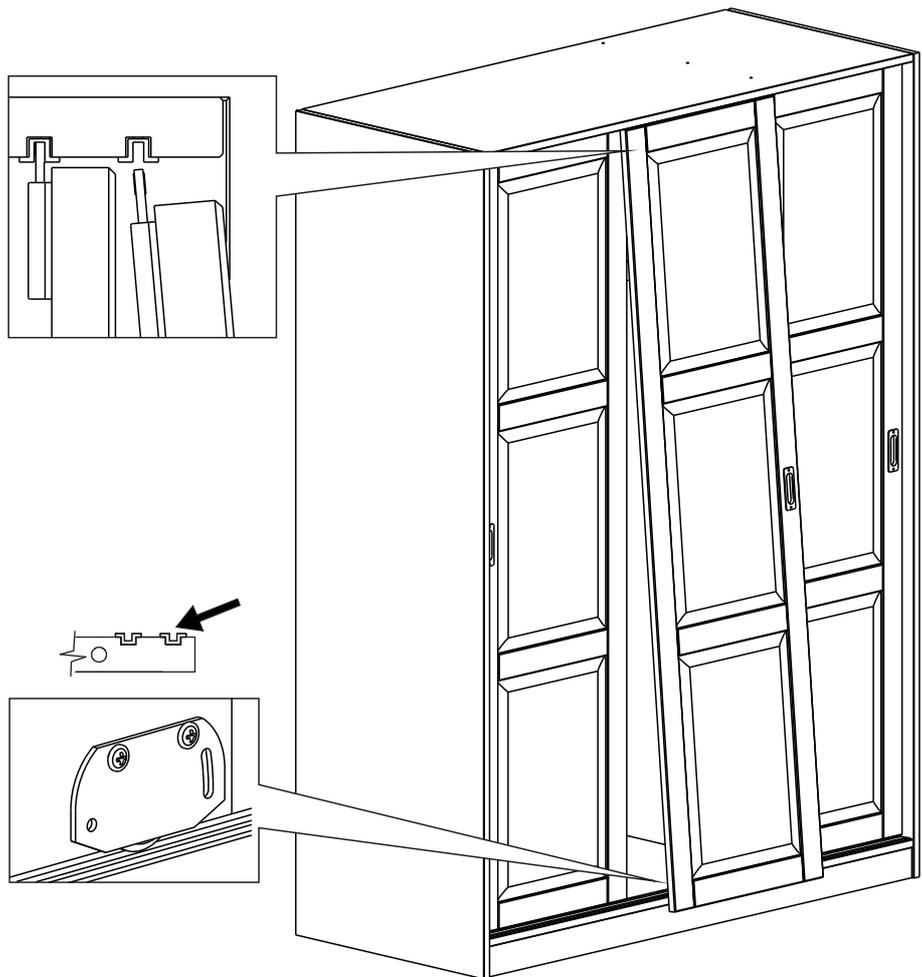
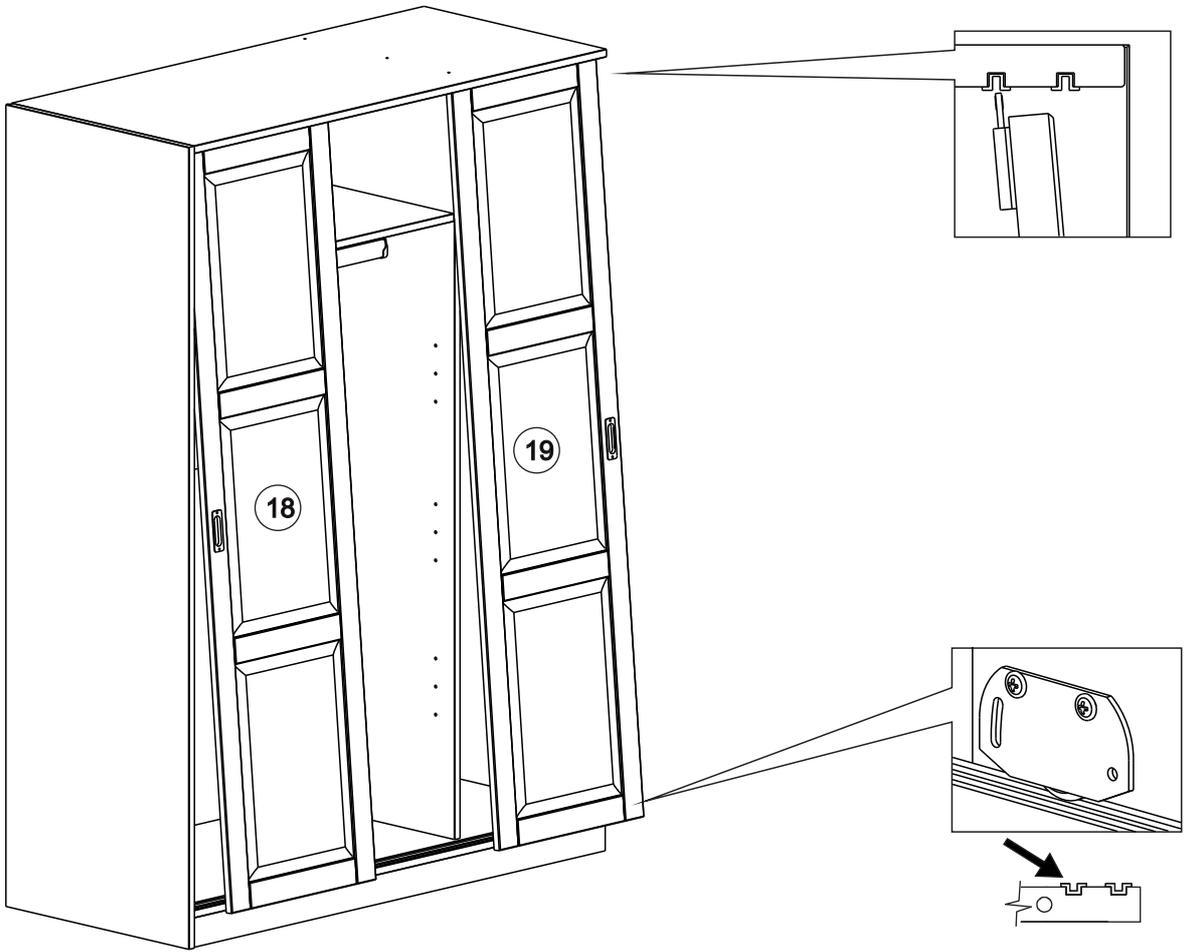

11)

Door Adjustment

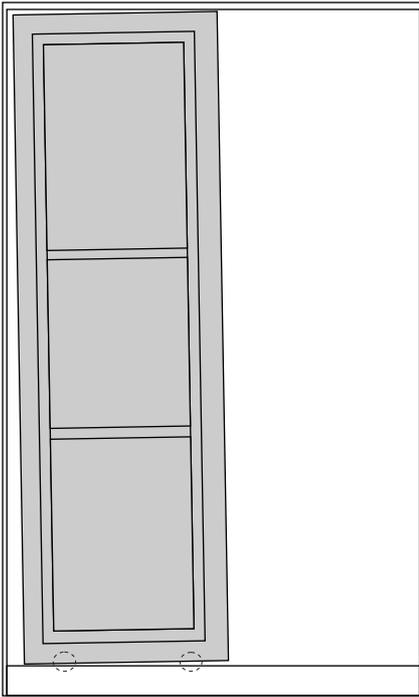

If a door is tilted to the left

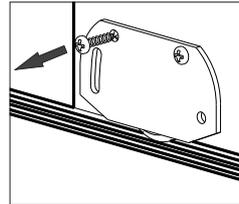

Step 1

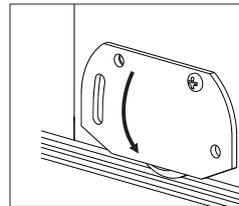

Step 2

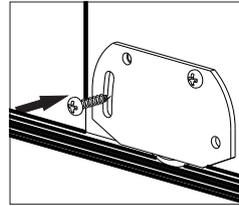

Step 3

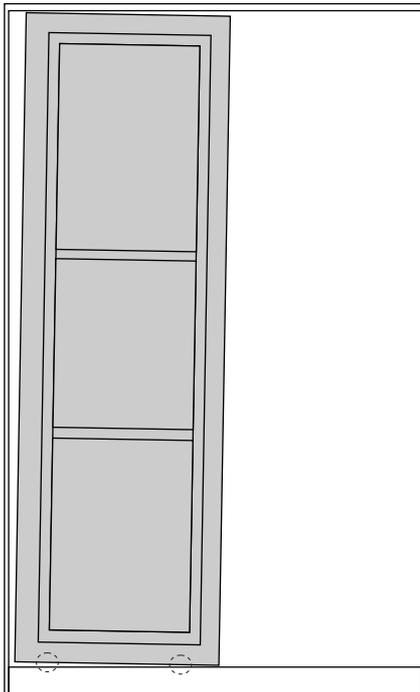

If a door is tilted to the right

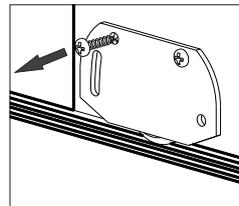

Step 1

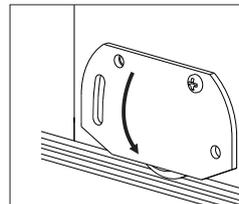

Step 2

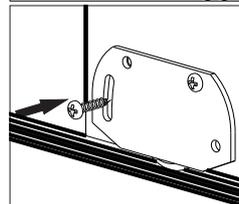

Step 3

12)

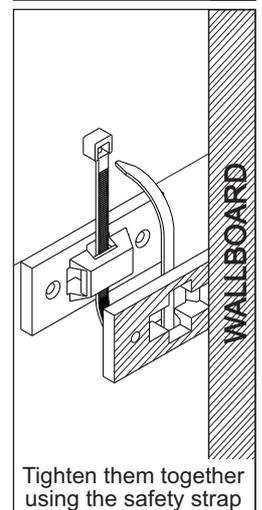
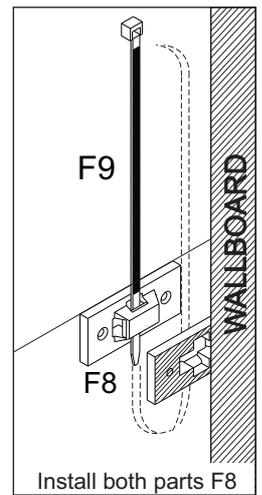
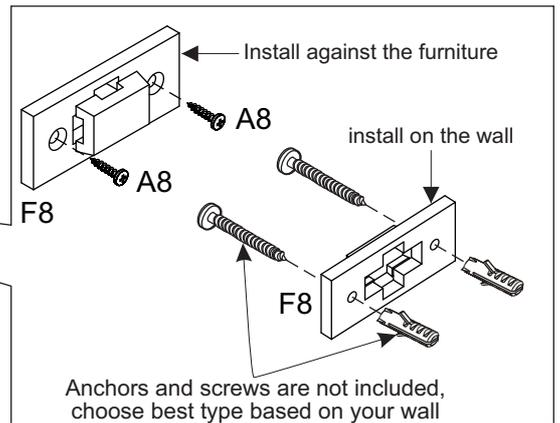
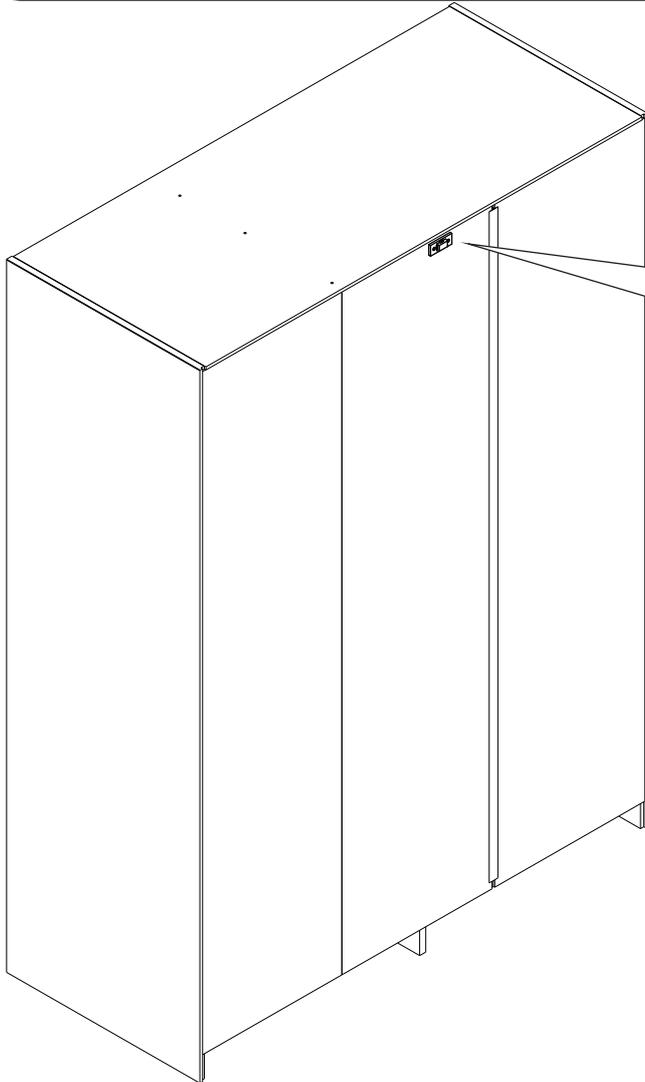
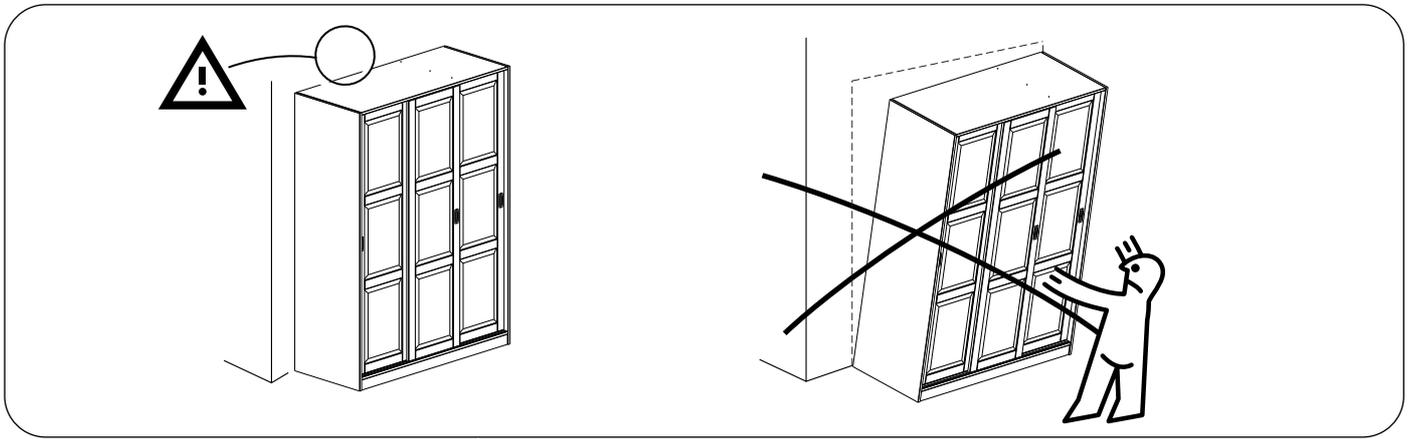

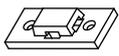
A8	 3.0x20	02
F8		02
F9		01